



CREATIVE KITCHENS

Tábula

CREATIVE KITCHENS

Tábula



OGNI PROGETTO NASCE DA UN'IDEA.

UN'IDEA DEVESSERE CAPACE
DI CONTAGIARE I PENSIERI
DI CHI LA ASCOLTA, LA GUARDA, LA TOCCA.

UN'IDEA PRENDE VITA E DIVENTA UNA COSA NUOVA
QUANDO INTERAGISCE CON LO SPAZIO
E CON LE SUE CONFIGURAZIONI,
CREANDO OGNI VOLTA SENSAZIONI DIVERSE.

QUESTO È LO SPIRITO DEL PROGETTO TABULA.

OGNI CUCINA TABULA
HA UNA STORIA DA RACCONTARE,
OGNI SUO MATERIALE
È UNICO: DAL LEGNO NUOVO
A QUELLO RECUPERATO,
ALLE PIETRE...
IL RISULTATO È
UN PRODOTTO NATURALE
DI GRANDE ESPRESSIVITÀ
E CALORE.

PROGETTO

01

FIANCO
PERSONALIZZABILE

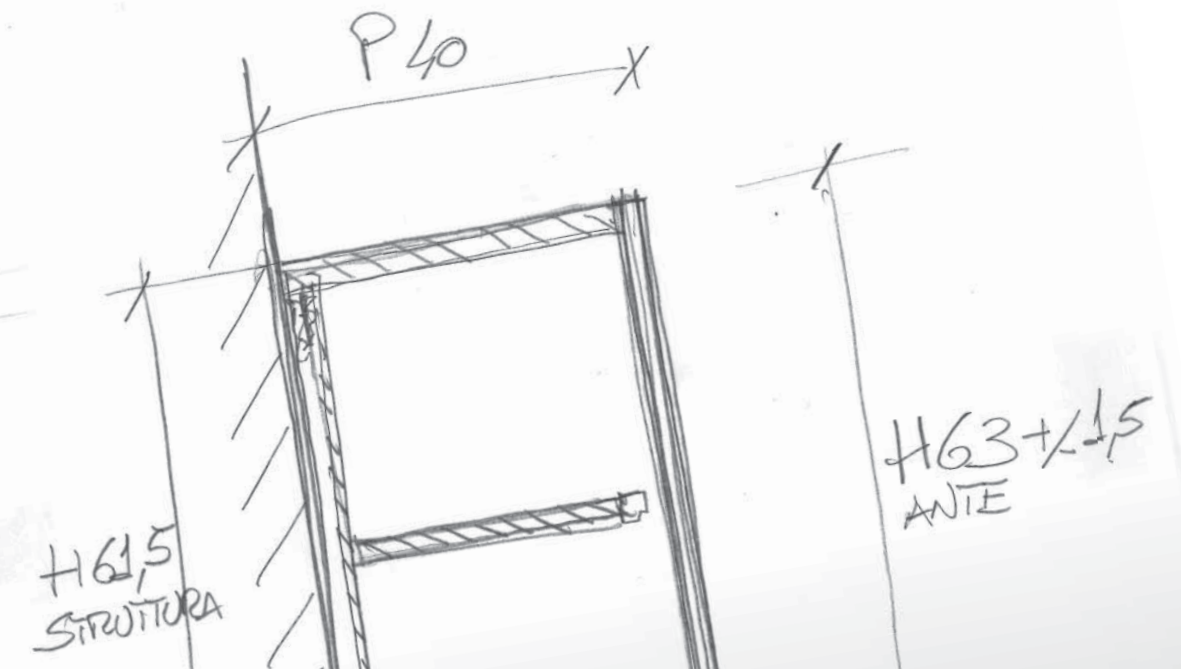
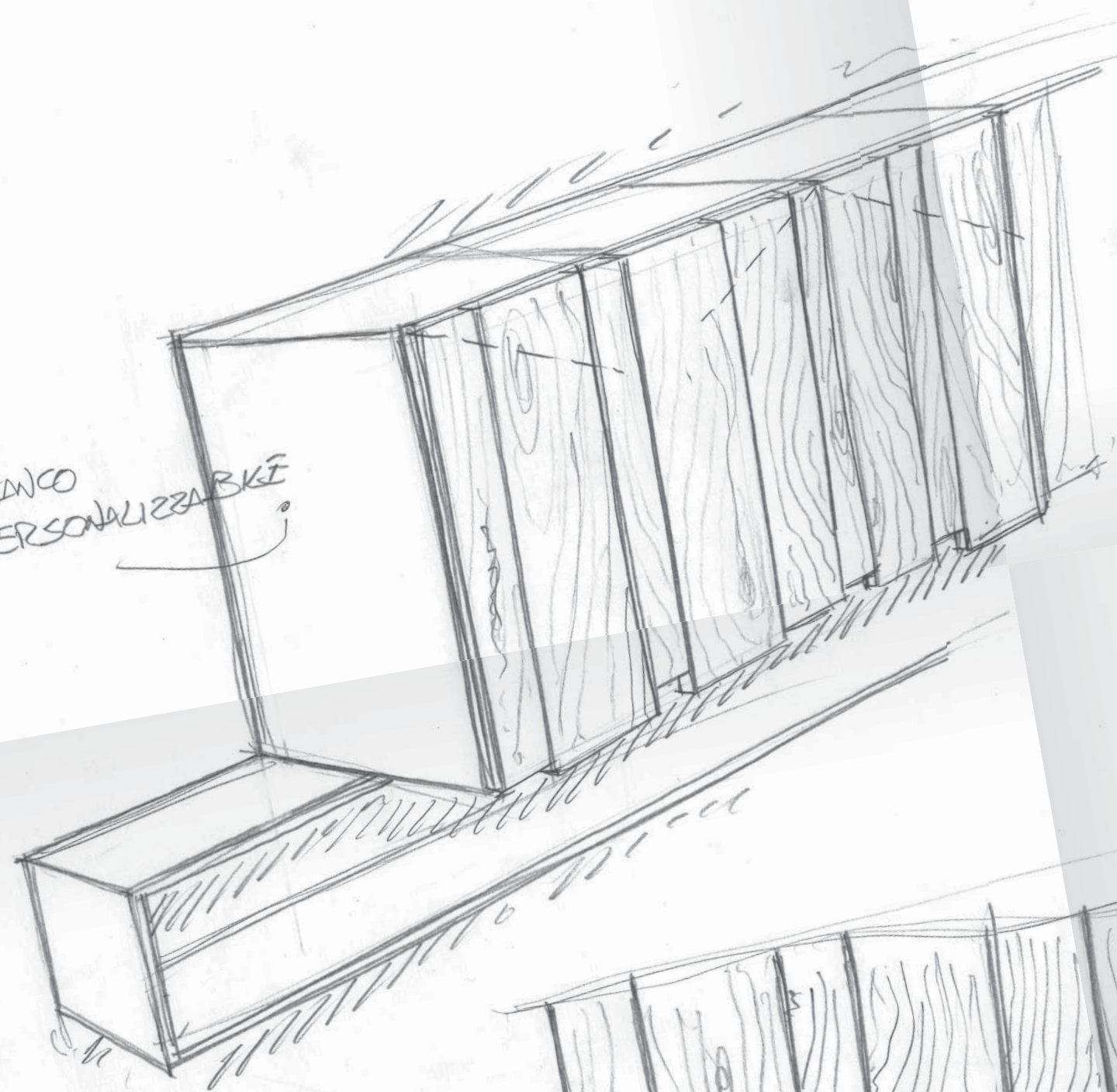

15

25

20

23

GOLA MANIGLIA

NOSSO BARRE
LUMINOSE

TAVOLA SOTTOPENSILE
PER FISSAGGIO
ELEMENTI SOPRAPIANO
E NOSSO LUCI

ABETE

ESTERNO
ABETE 14 PATAWA

15

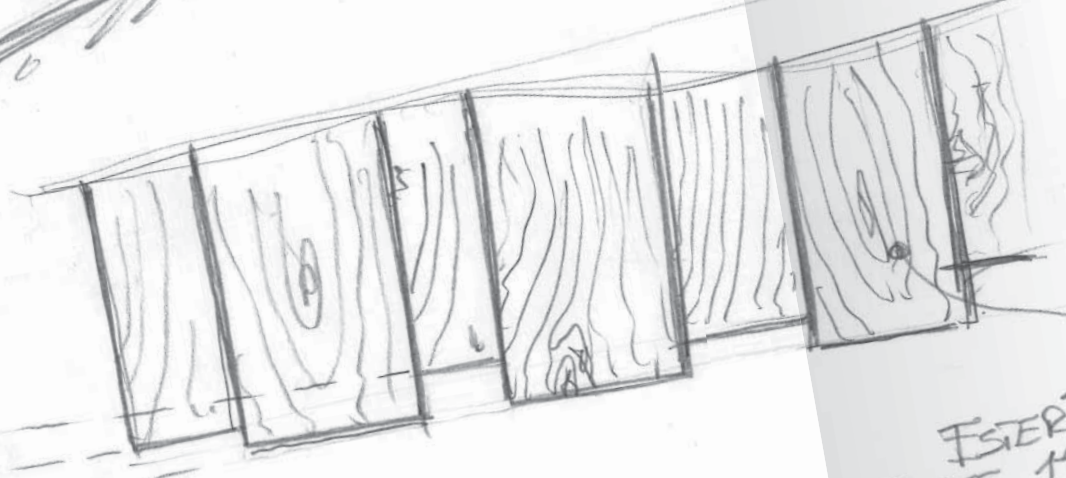







TAVOLE 1ª PATINA PROGRAMMA PENSILI IN ABETE CON EFFETTO TAVOLE
SOPRAPIANO PAPERSTONE PROGRAMMA CONTENITORI A GIORNO MINIMALI



DOORS ROVERE LACCA MOBILI CUCINA
I BANCHI BANCO OPERATIVO IN FERRO
AQUALTA VASCA LAVELLO IN PIETRA ASSEMBLATA
SOPRAPIANO PAPERSTONE PROGRAMMA CONTENITORI A GIORNO MINIMALI
TAVOLE 1ª PATINA PROGRAMMA PENSILI IN ABETE CON EFFETTO TAVOLE

DOORS ROVERE LACCA MOBILI CUCINA
I BANCHI BANCO OPERATIVO IN FERRO
TAVOLE 1ª PATINA PROGRAMMA PENSILI IN ABETE CON EFFETTO TAVOLE





MANIGLIA CATENACCIO



CAPPA FOGLIO
L 90 / 120 / 150 CM



PROGRAMMA SOPRAPIANO

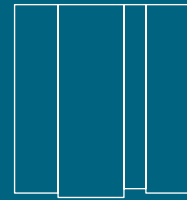

PROGRAMMA TAVOLE 1ª PATINA

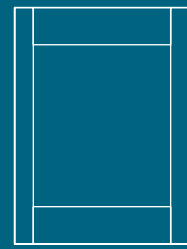

PROGRAMMA ANTA DOORS

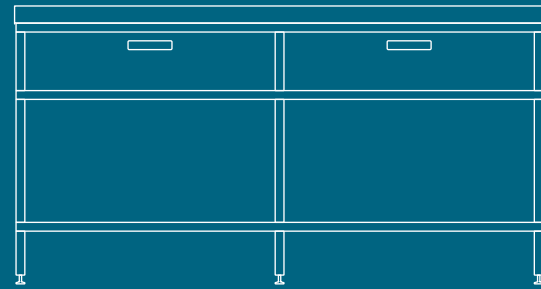

PROGRAMMA I BANCHI
L 120 / 180 / 240 CM
P 65 / 105 CM

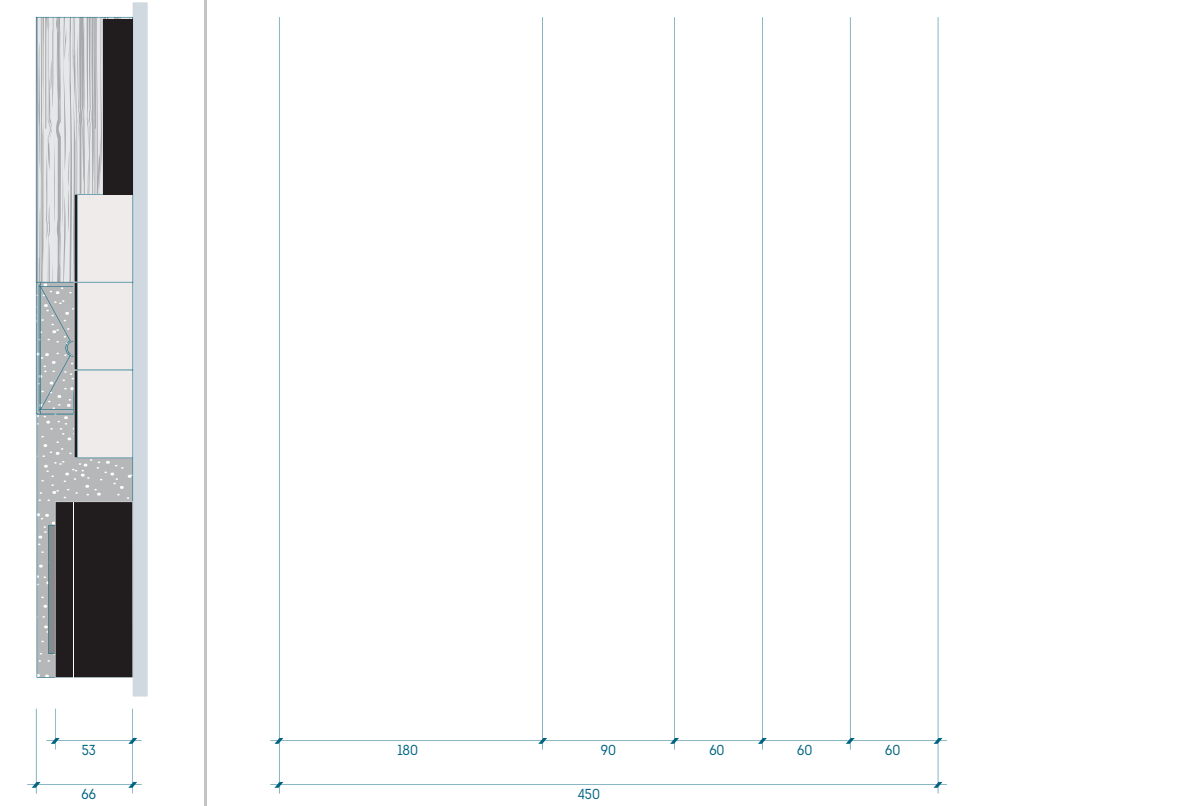
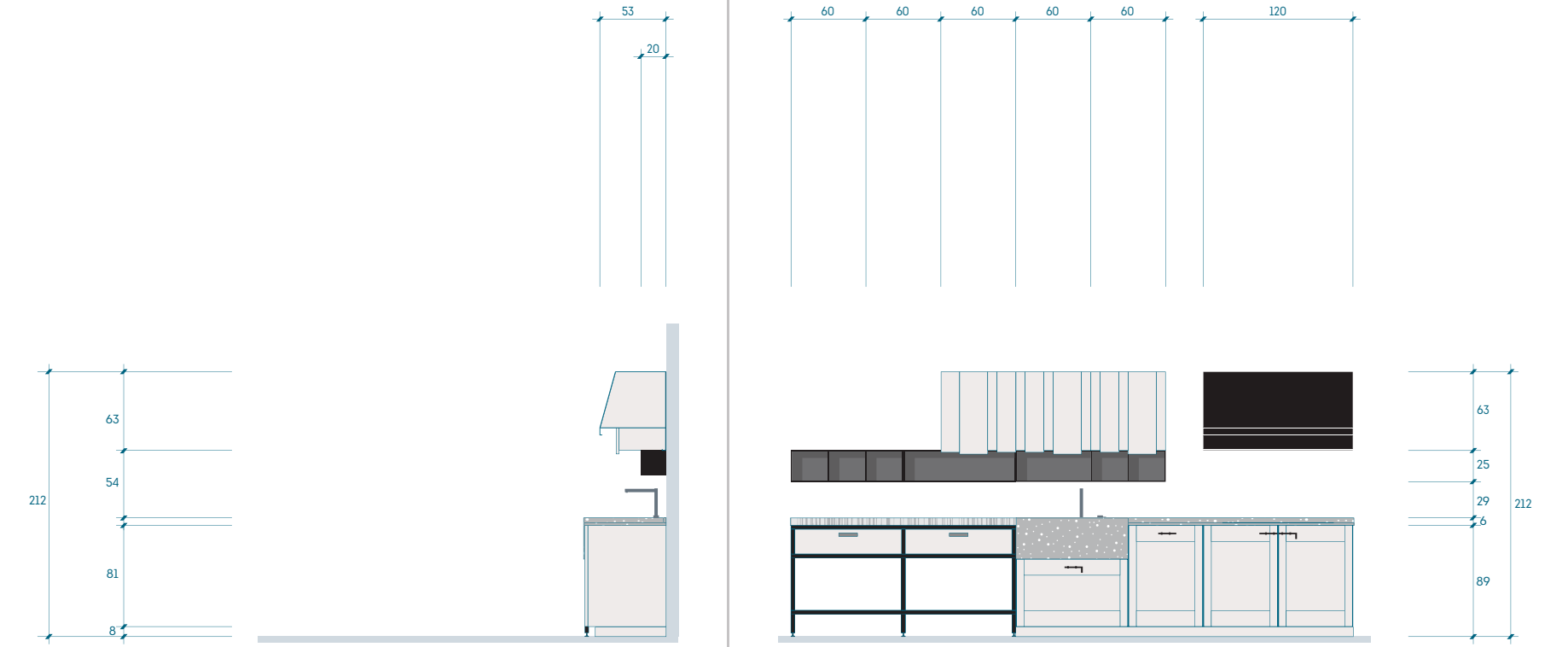

OGNI CUCINA TABULA
È UN PROGETTO UNICO
E ARREDA LO SPAZIO
CON CARATTERE,
SENZA CHE NULLA SIA
LASCIATO AL CASO.
FATTURA ARTIGIANALE
E ARTE MANIFATTURIERA
SONO ALLA BASE
DI OGNI NOSTRA REALIZZAZIONE

PROGETTO

02

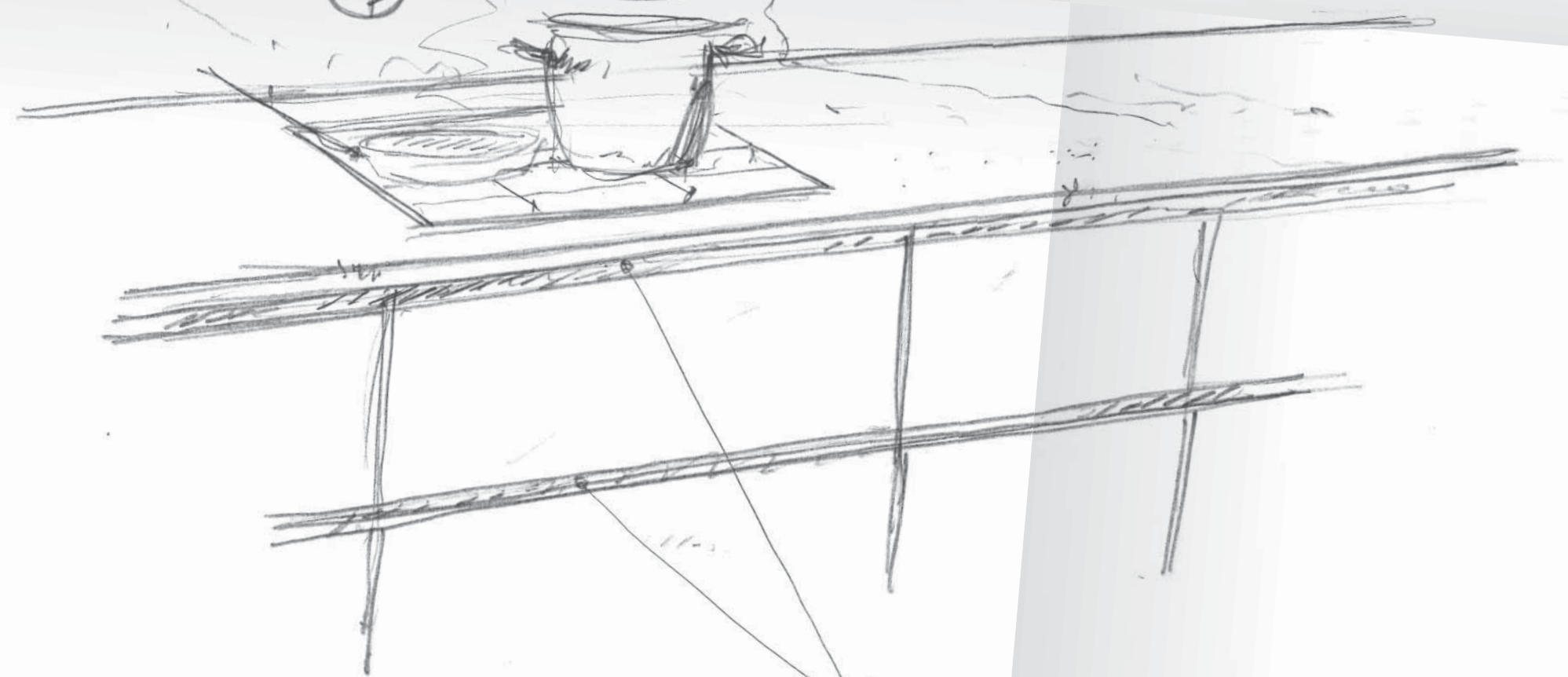
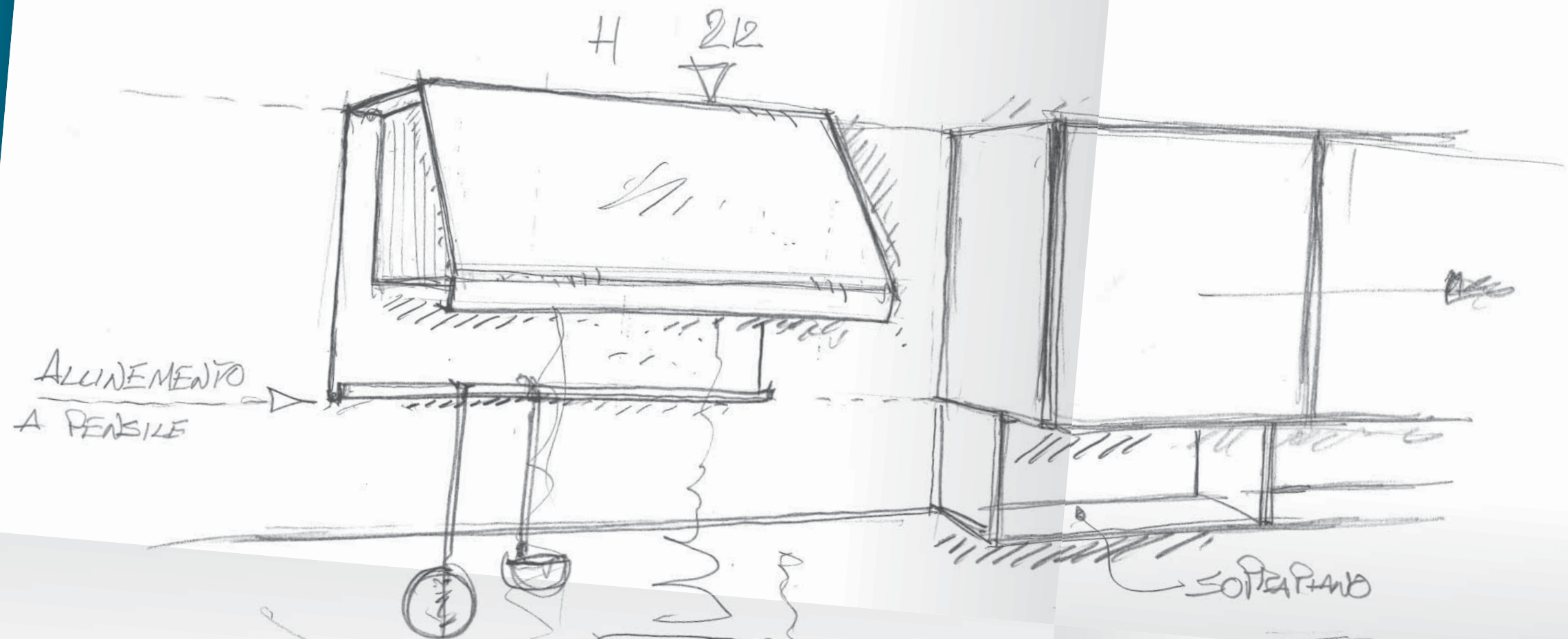

GOLE VERNICIATE A POLVERI

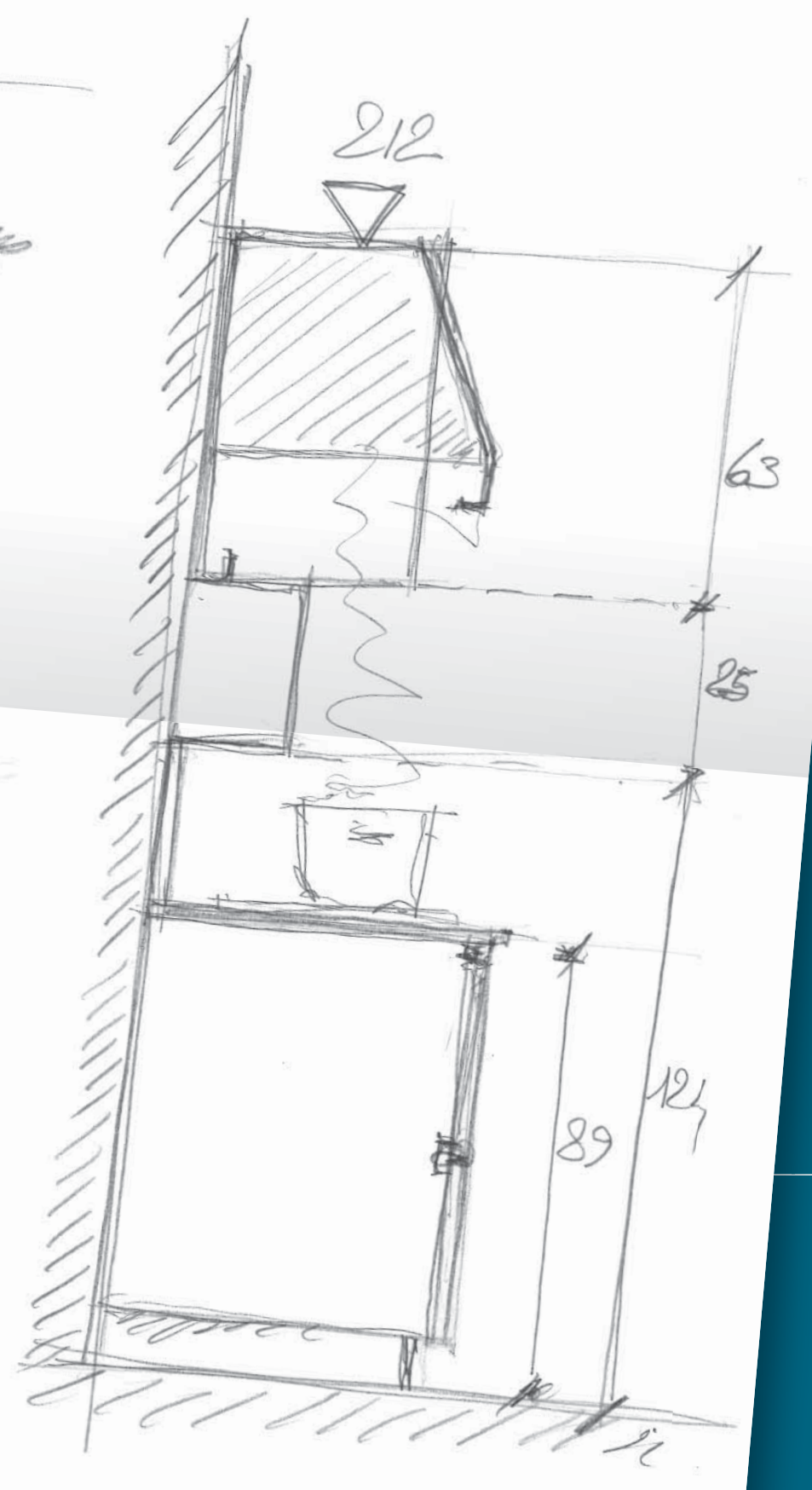

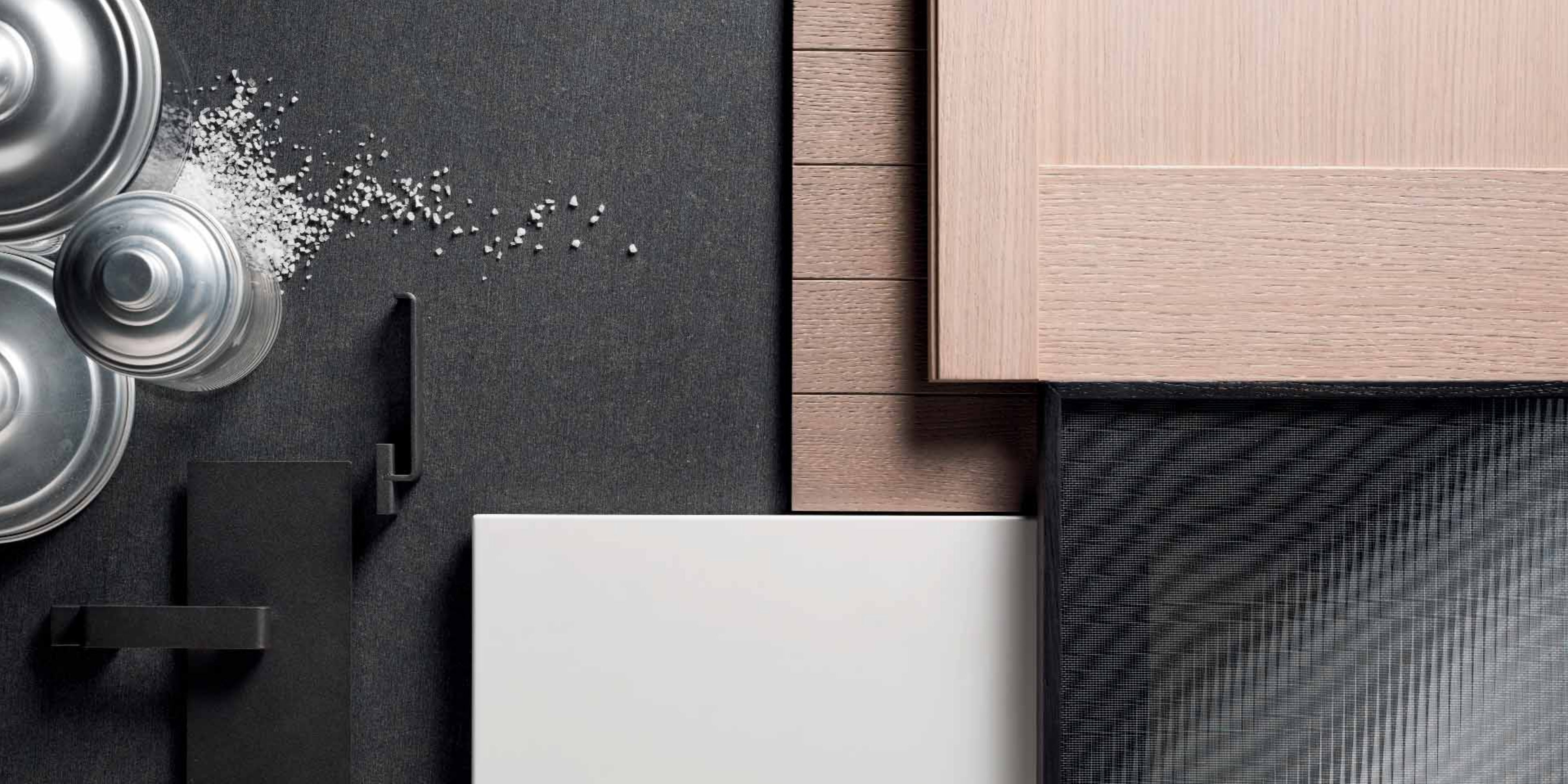

DOORS ROVERE MOBILI CUCINA
ARMADIA MADIA
FOGLIO CAPPAA A PARETE
GLASS PROGRAMMA PENSILI VETRO
AQUAALTA VASCA LAVELLO IN PIETRA ASSEMBLATA
I BANCHI BANCO OPERATIVO IN FERRO
CATENACCIO MANIGLIA IN FERRO





DOORS ROVERE MOBILI CUCINA
GLASS PROGRAMMA PENSILI VETRO
AQUAALTA VASCA LAVELLO IN PIETRA ASSEMBLATA
SOPRAPIANO PAPERSTONE PROGRAMMA CONTENITORI A GIORNO MINIMALI





I BANCHI BANCO OPERATIVO IN FERRO



GLASS PROGRAMMA PENSILI VETRO





MANIGLIA CATENACCIO

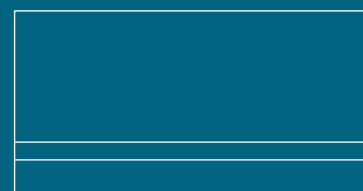

CAPPA FOGLIO
L 90 / 120 / 150 CM



PROGRAMMA SOPRAPIANO

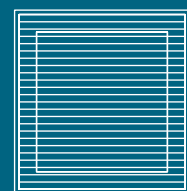

PROGRAMMA ANTA GLASS

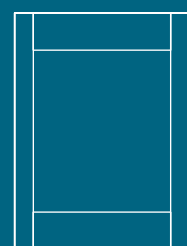

PROGRAMMA ANTA DOORS

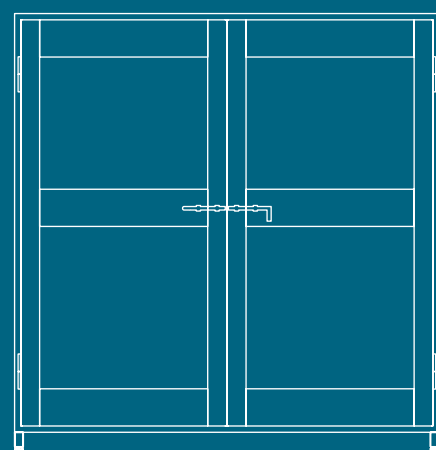

ARMADIA
L 145 CM
H 143 CM
P 50 / 65 CM

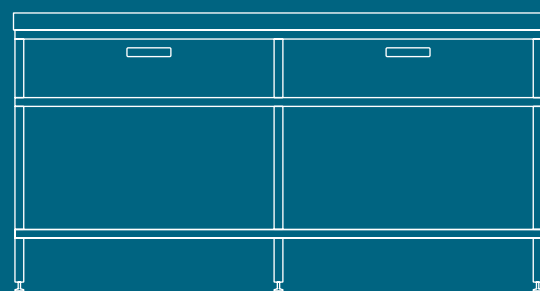

PROGRAMMA I BANCHI
L 120 / 180 / 240 CM
P 65 / 105 CM

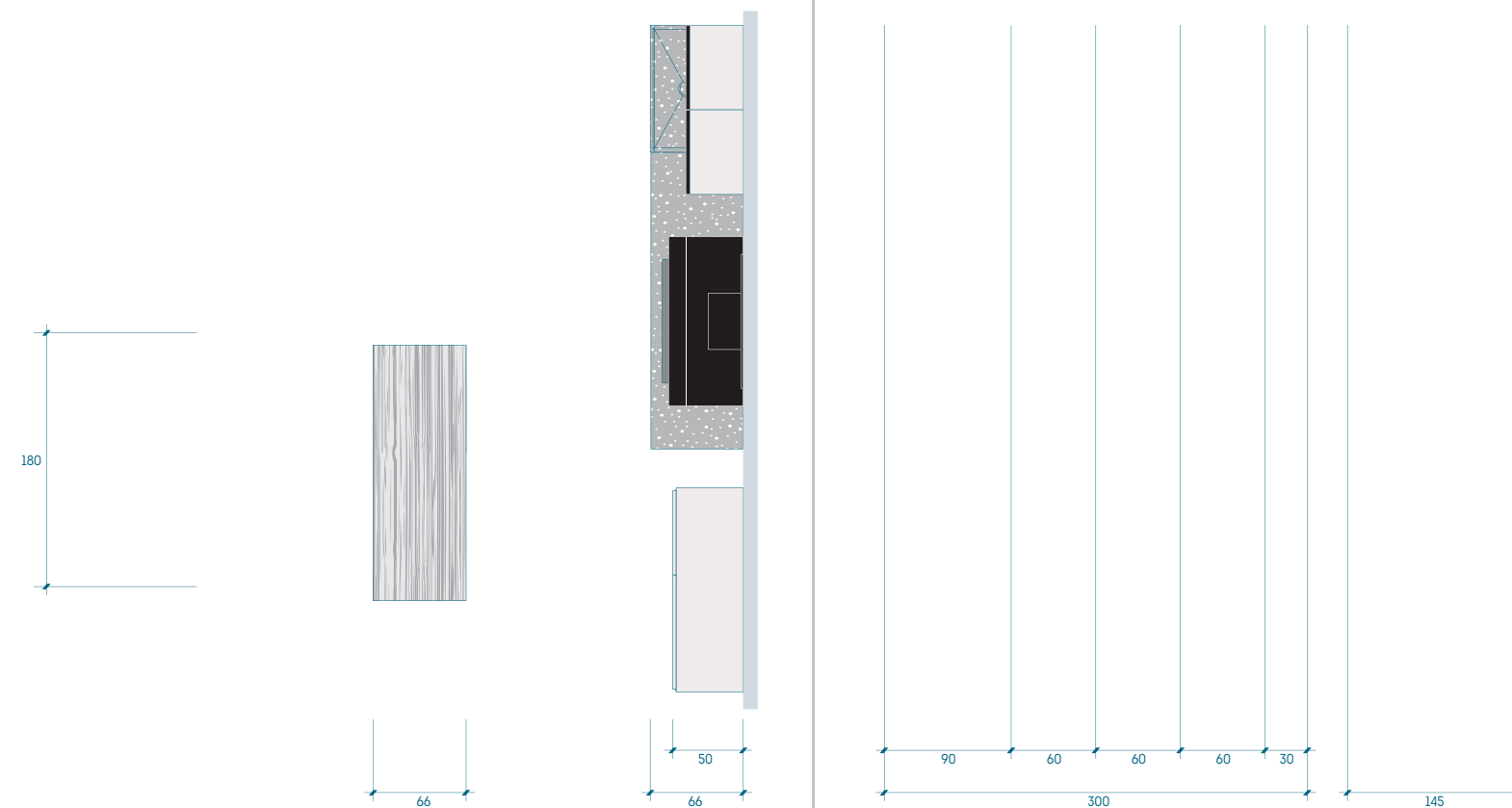
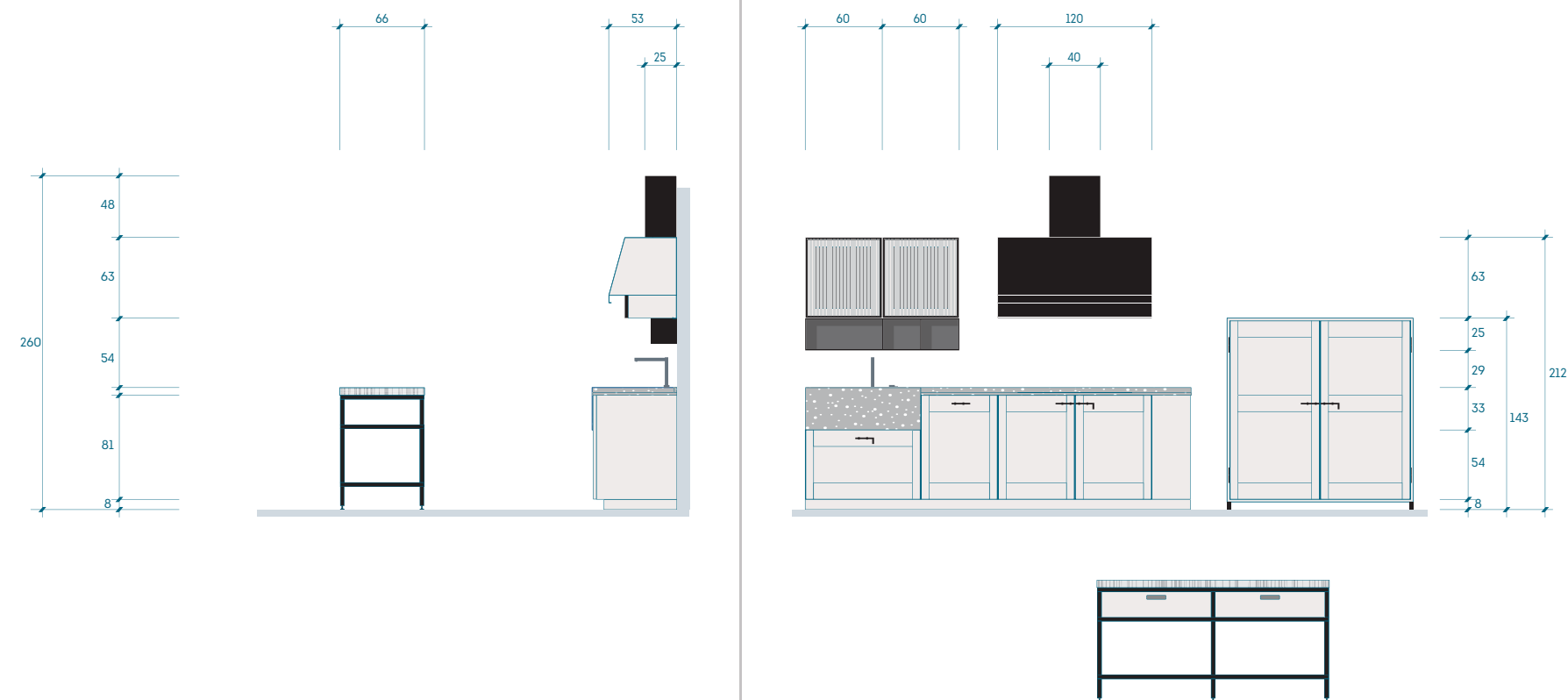

OGNI CUCINA TABULA
È LA SOMMA
DI TANTI PICCOLI DETTAGLI,
LE MATERIE SI FONDONO
ARMONICAMENTE
PER REALIZZARE UN PROGETTO
MODELLATO SULLO STILE DI VITA
DI CHI LO POSSIEDE

PROGETTO

03

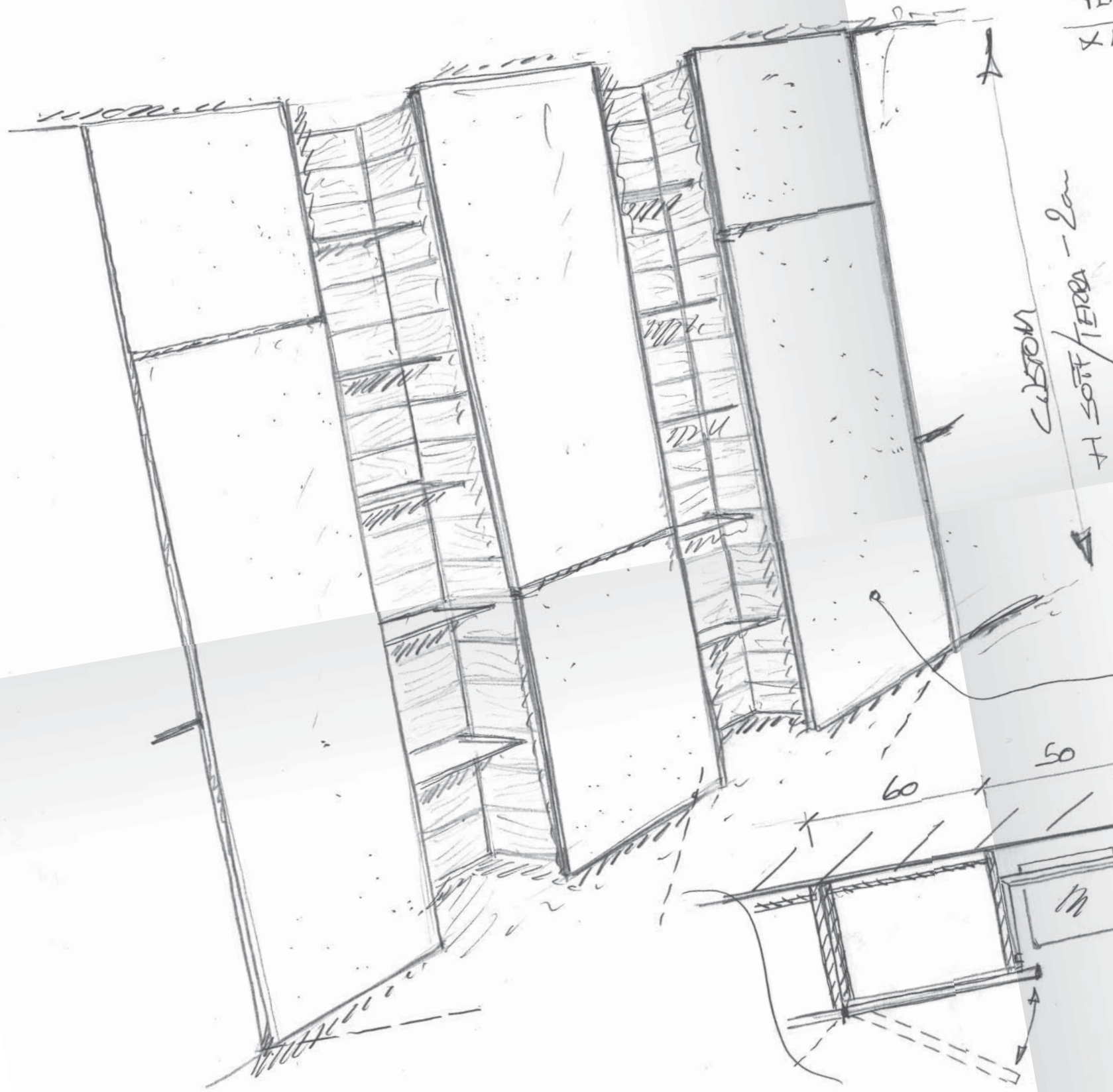

25
XXX
FERROIA 3mm
X MENSOLE FERRO

C.I. BENTON
2cm
H. SOTT. TERRA

15
15
15
15
15
15
15
15
15
15
SCALINA A GIORNO BASSO 15

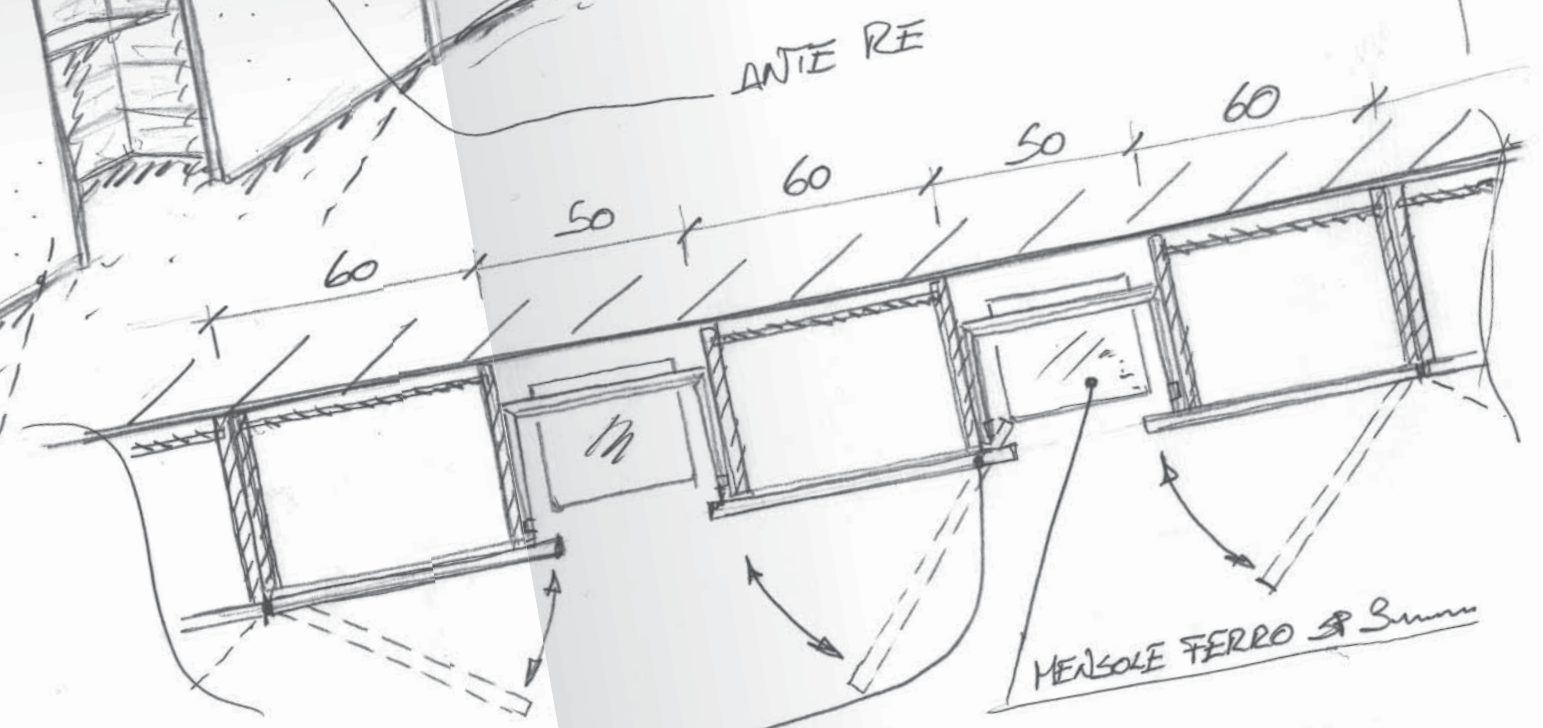

ANTE RE

60 50 60 50 60

MENSOLE FERRO 3mm

BILICO





WINGS LARICE LACCA MOBILI CUCINA
BRIDGE LARICE SISTEMA BANCHI MULTIFUNZIONALI
WALL RESINA SISTEMA CONTENIMENTO PARETE A SCOMPARSA
CUBE CAPPA A SOFFITTO

WINGS LARICE LACCA MOBILI CUCINA





WALL RESINA SISTEMA CONTENIMENTO PARETE A SCOMPARSA
CUBE CAPPA A SOFFITTO
WINGS LARICE LACCA MOBILI CUCINA





BRIDGE LARICE SISTEMA BANCHI MULTIFUNZIONALI
WINGS LARICE MOBILI CUCINA
CUBE CAPP A SOFFITTO

WALL RESINA SISTEMA CONTENIMENTO PARETE A SCOMPARSA



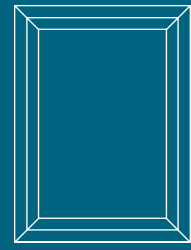

PROGRAMMA ANTA WINGS



PROGRAMMA SOPRAPIANO

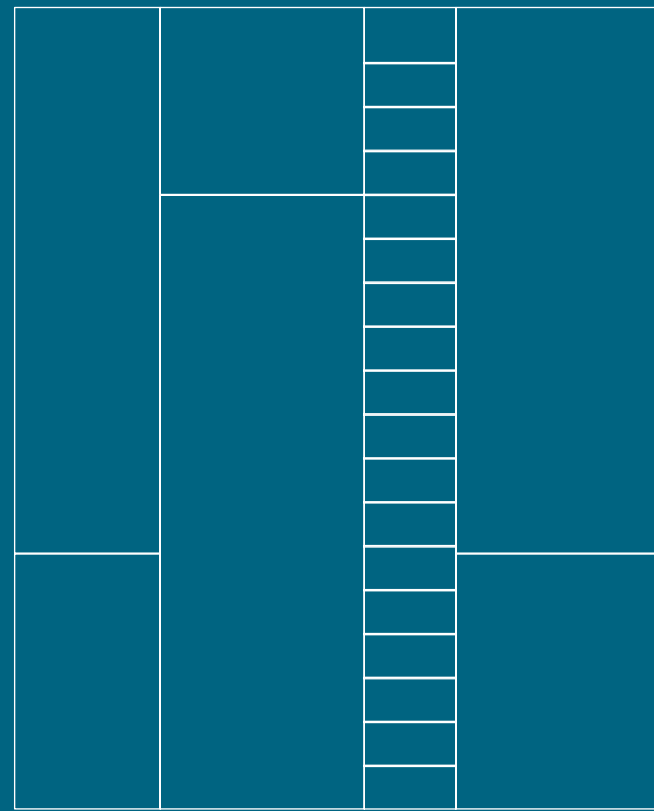

PROGRAMMA WALL RESINA

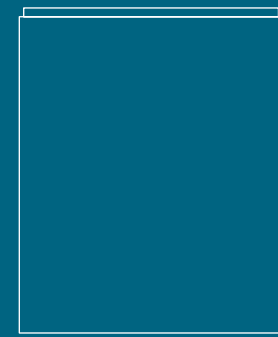

CAPPA CUBE

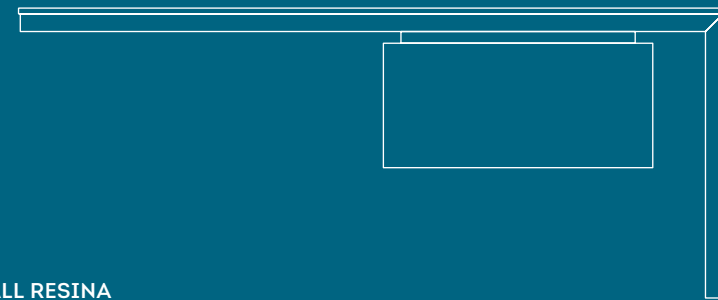

PROGRAMMA BRIDGE

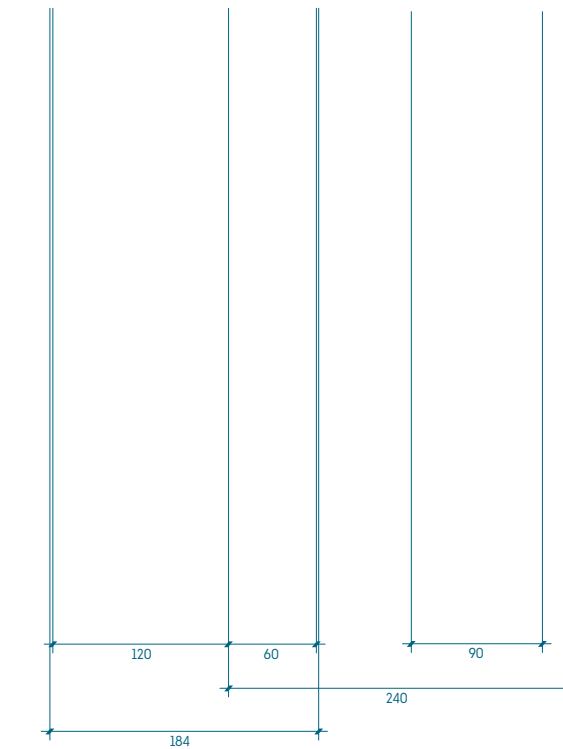
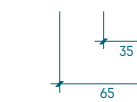
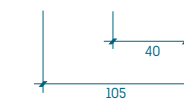
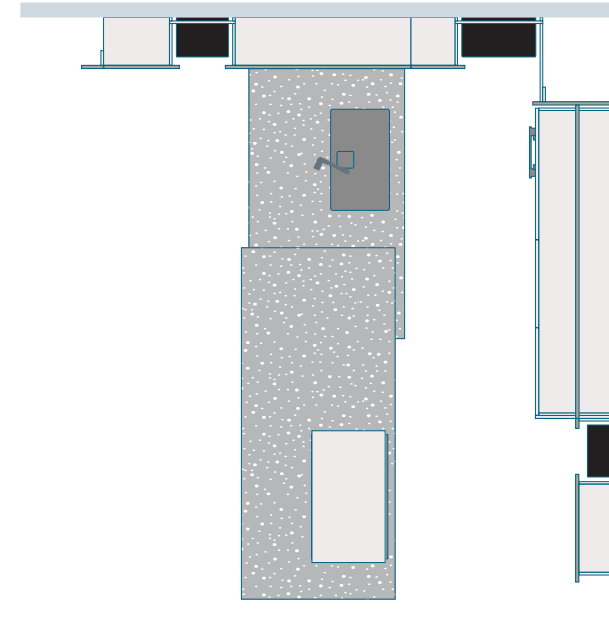
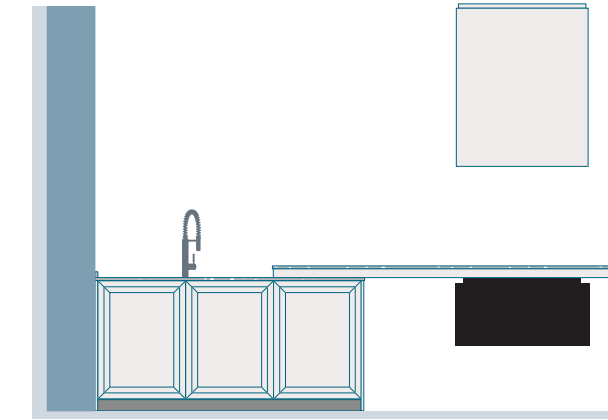
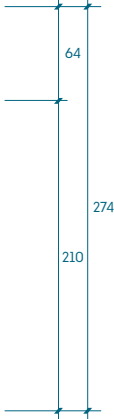
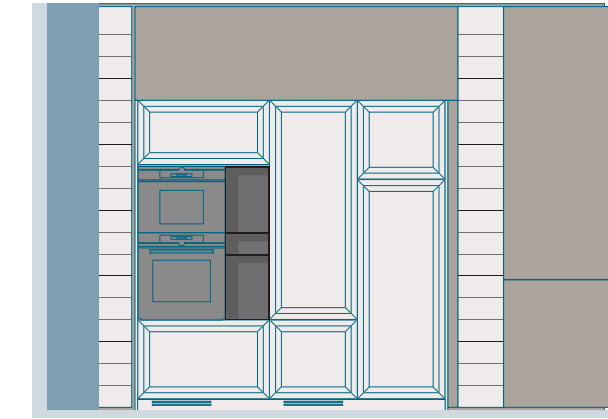
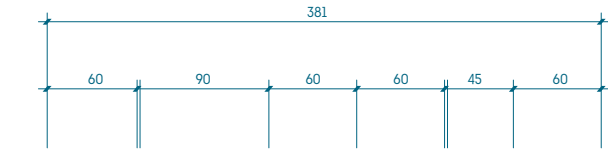
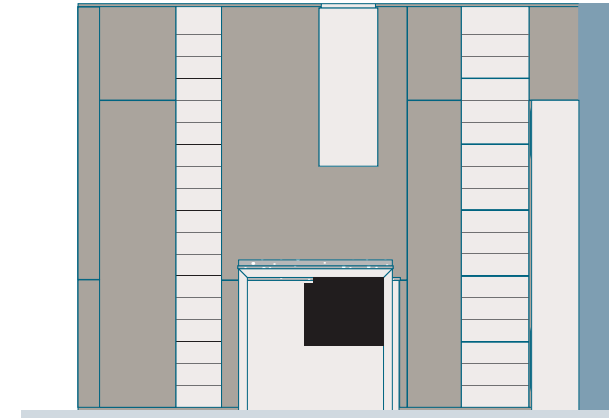
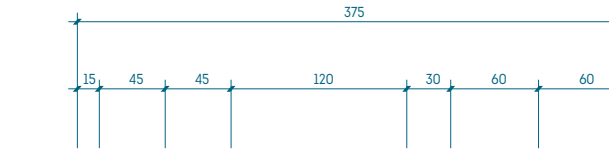

OGNI CUCINA TABULA
È REALIZZATA
PER TUTTI COLORO CHE
ANCORA HANNO UN'IDEA CREATIVA
E APPREZZANO L'EMOZIONE
DI VEDERLA NASCERE E CRESCERE
DAI PROPRI PENSIERI,
DALLA SELEZIONE DELLE MATERIE
DAL LORO ACCOSTAMENTO,
DALLA DIMENSIONE NELLO SPAZIO

PROGETTO



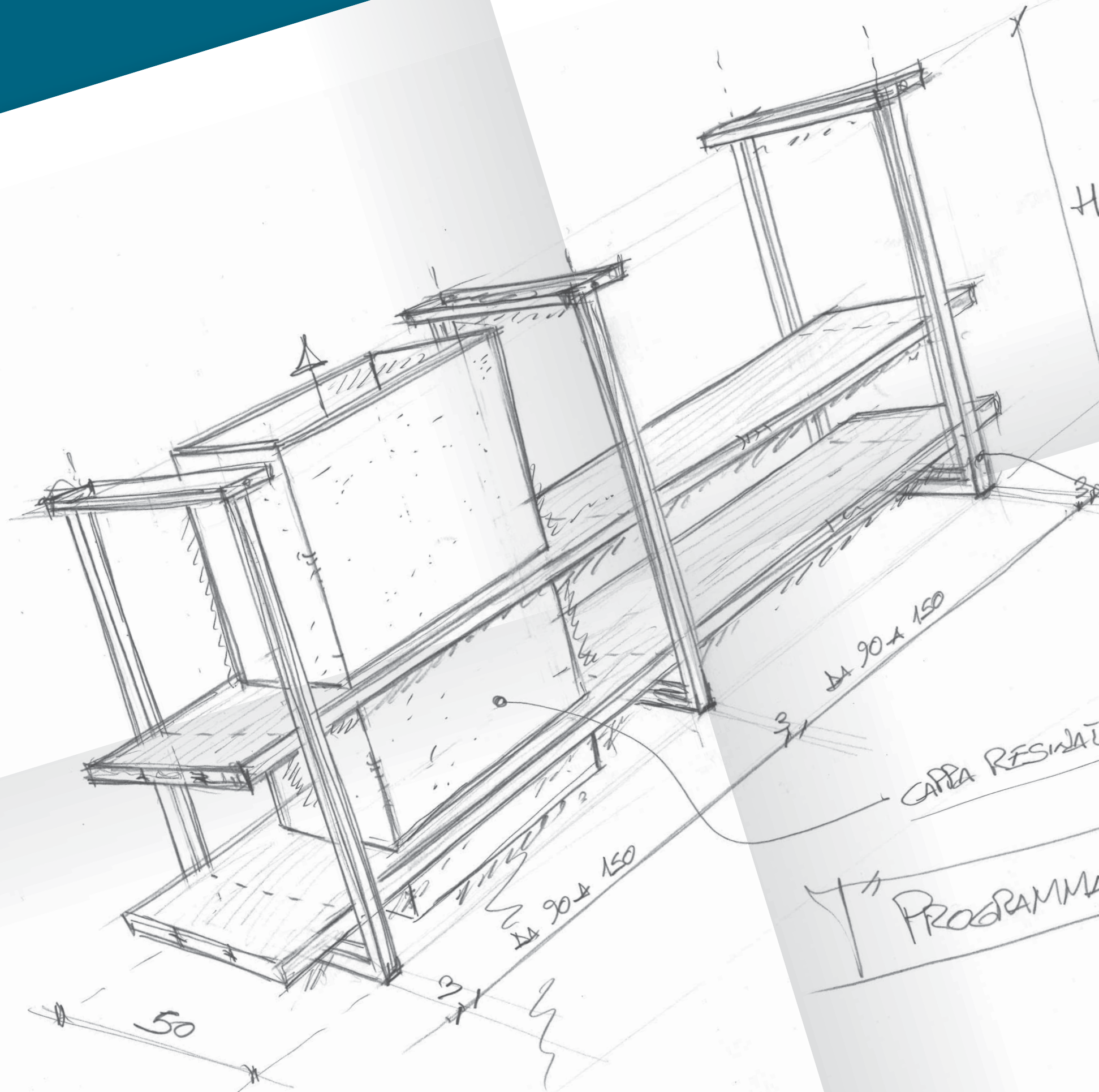

H DA 110 A 110

DA 90 A 150

TUBOLARE 3x3
VERNICIATO A POWERY

CAPPA RESINATA

PROGRAMMA SOPRALCO

DA 90 A 150

50

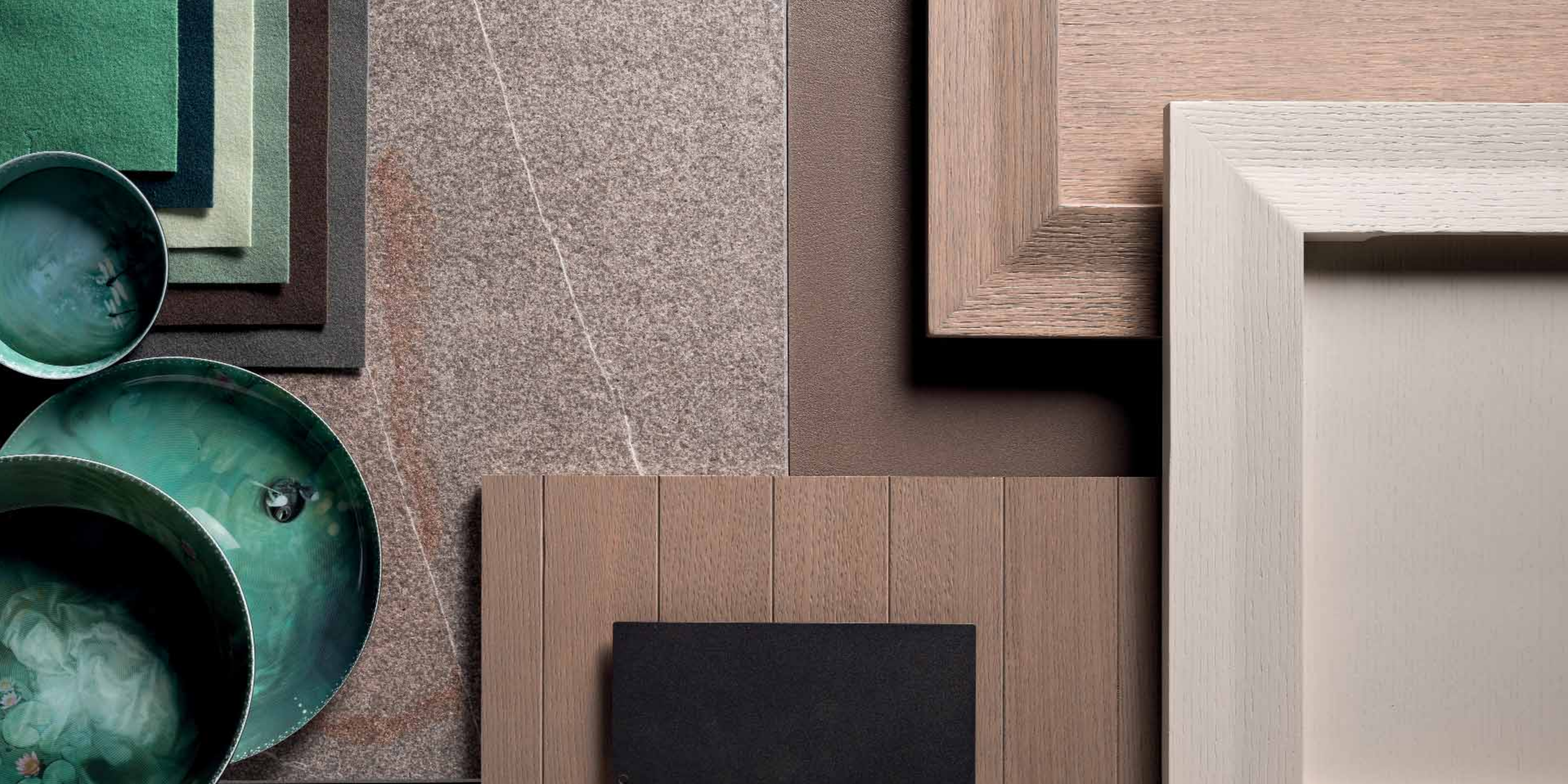

WINGS ROVERE LACCA MOBILI CUCINA
WINGS ROVERE TINTA MOBILI CUCINA
WALL RESINA SISTEMA CONTENIMENTO PARETE A SCOMPARSA
SOPPALCO CAPPA





WINGS ROVERE LACCA MOBILI CUCINA
WALL RESINA SISTEMA CONTENIMENTO PARETE A SCOMPARSA
SOPPALCO CAPPA

WINGS ROVERE LACCA MOBILI CUCINA
WINGS ROVERE TINTA MOBILI CUCINA
WALL RESINA SISTEMA CONTENIMENTO PARETE A SCOMPARSA
SOPRAPIANO PAPERSTONE PROGRAMMA CONTENITORI A GIORNO MINIMALI
SOPPALCO CAPPRA





WINGS ROVERE TINTA MOBILI CUCINA





WALL RESINA SISTEMA CONTENIMENTO PARETE A SCOMPARSA





WINGS ROVERE TINTA MOBILI CUCINA
WALL RESINA SISTEMA CONTENIMENTO PARETE A SCOMPARSA
SOPPALCO CAPPA

SOPPALCO CAPPA





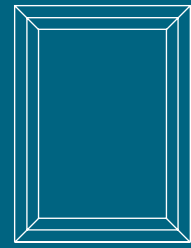

PROGRAMMA ANTA WINGS



PROGRAMMA SOPRAPIANO

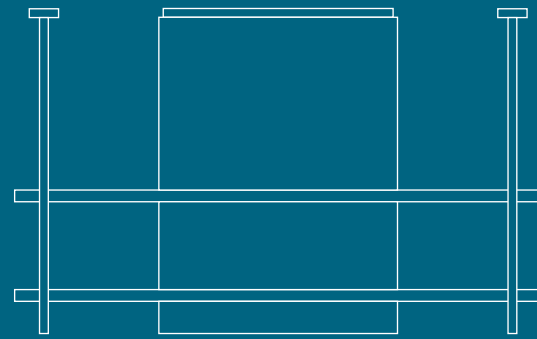

CAPPA SOPPALCO

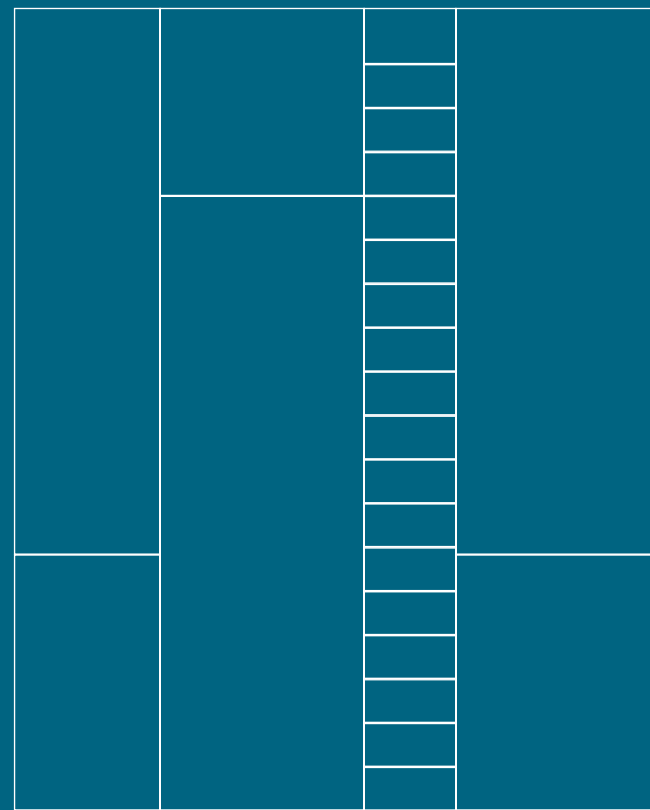

PROGRAMMA WALL RESINA

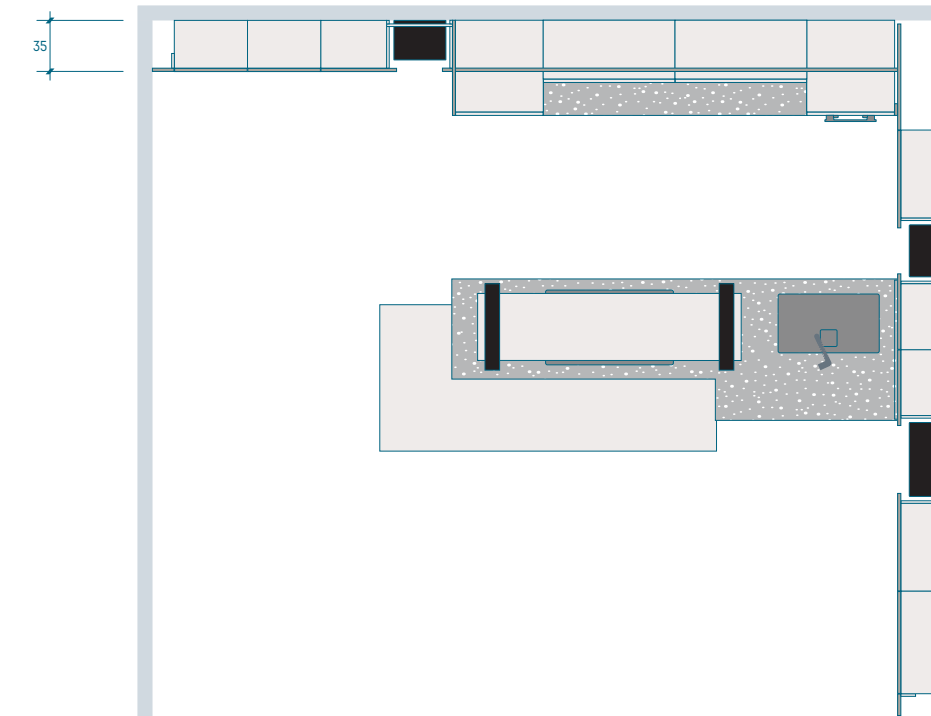
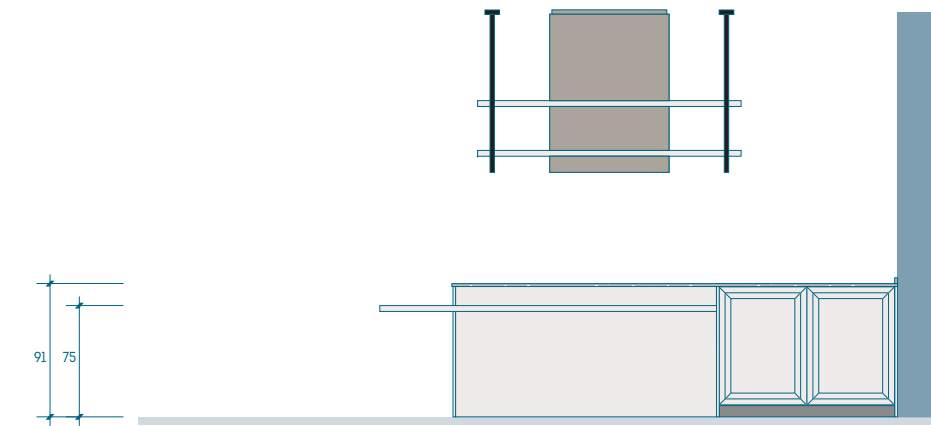
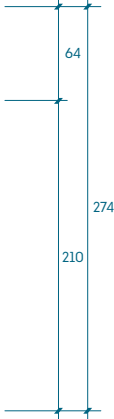
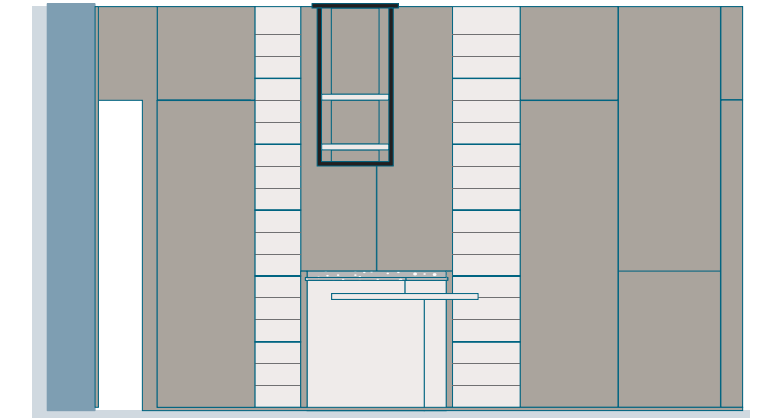
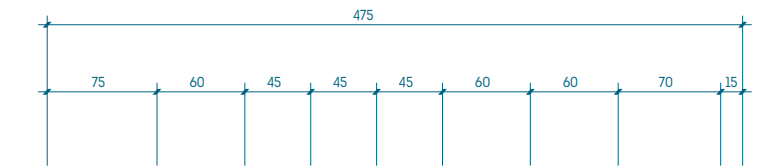
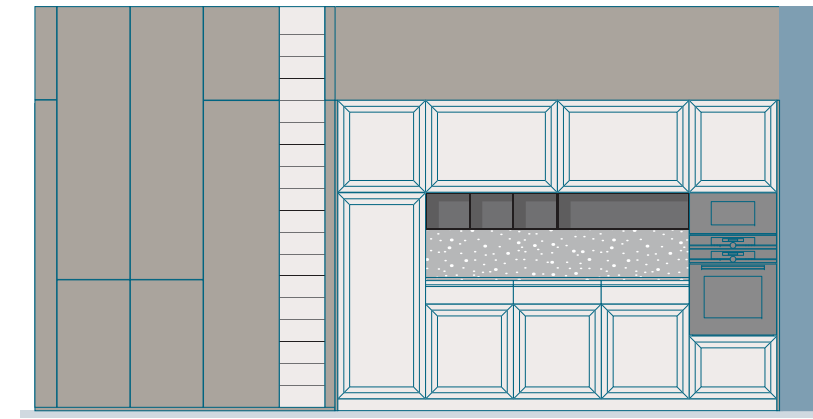
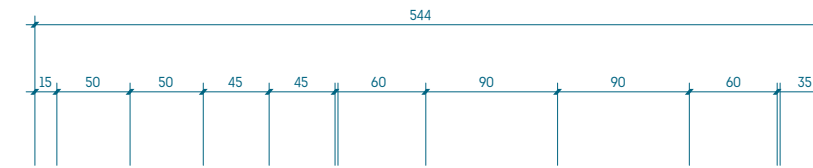

OGNI CUCINA TABULA
È UN AMBIENTE DI VITA,
UN LUOGO UNICO
DOVE RITROVARSI, COMUNICARE,
RILASSARSI E SENTIRSI
FINALMENTE A CASA,
IN UNO SPAZIO SENZA TEMPO
DOVE TROVARE IL BENESSERE
QUOTIDIANO

PROGETTO

05

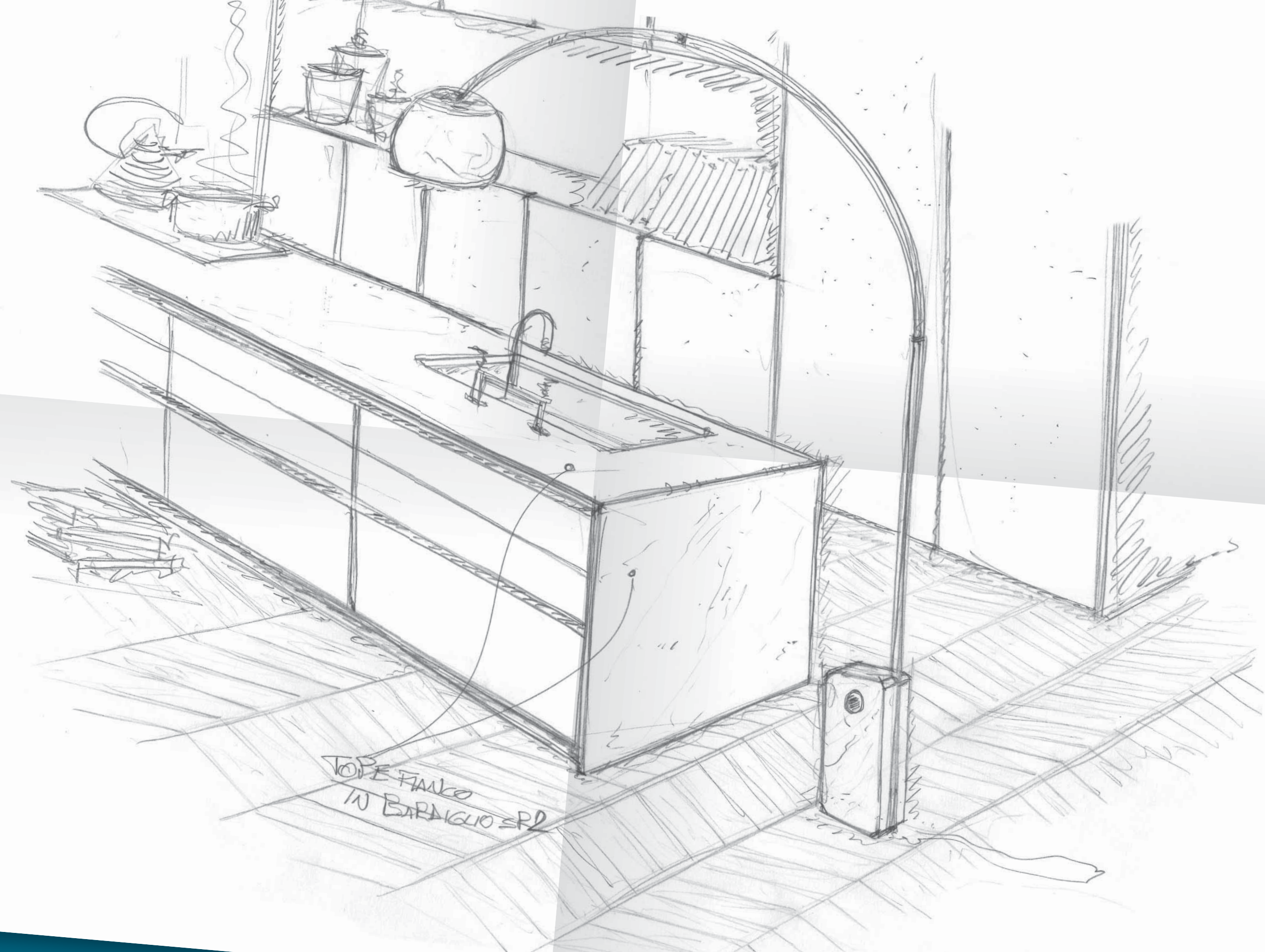

TOPE FINCO
IN BARRIGLIO SPD

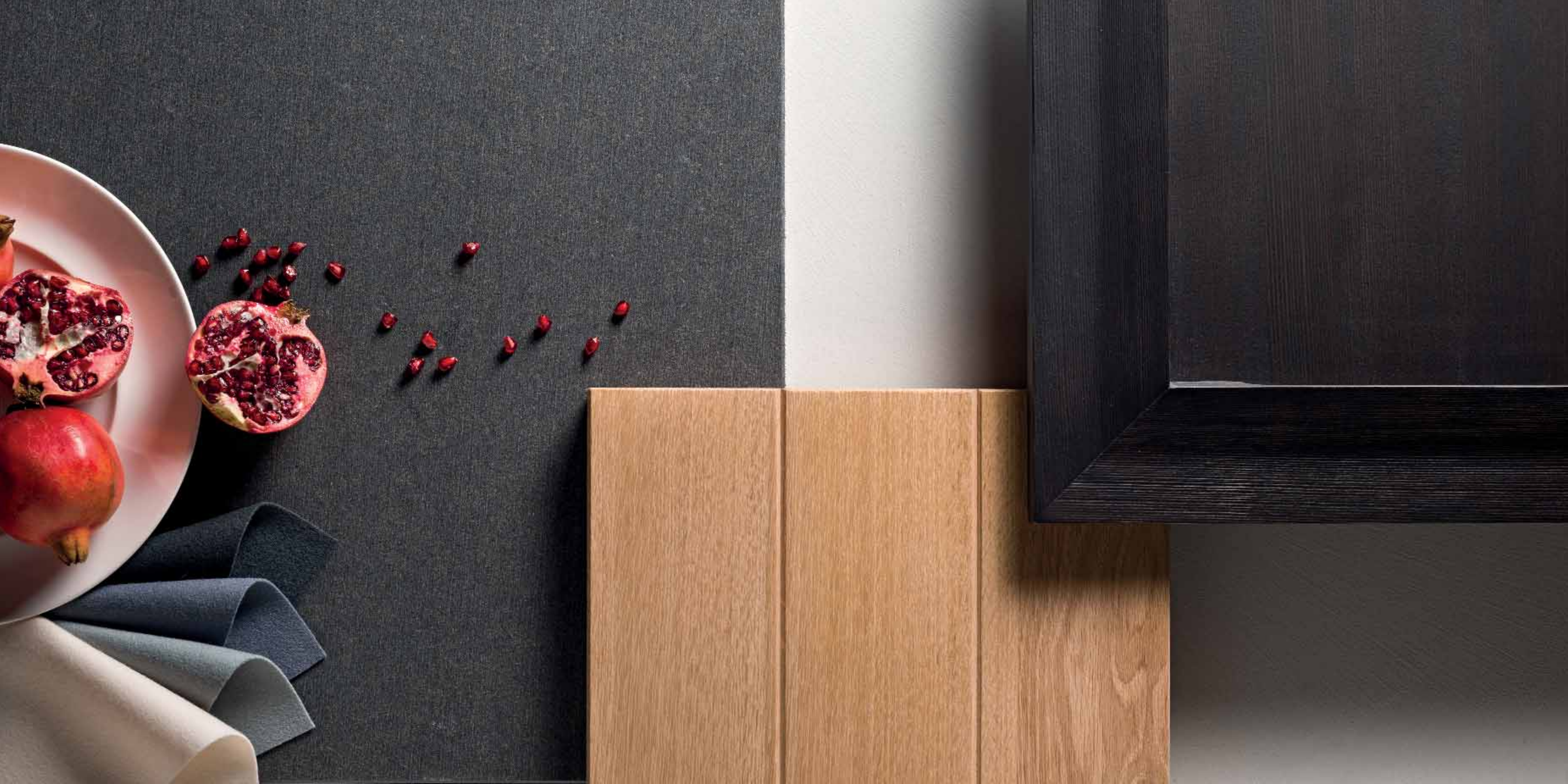





WINGS ROVERE LACCA MOBILI CUCINA
WALL RESINA SISTEMA CONTENIMENTO PARETE A SCOMPARSA





WINGS ROVERE LACCA MOBILI CUCINA
WINGS ROVERE TINTA MOBILI CUCINA



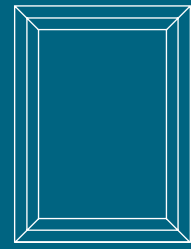

PROGRAMMA ANTA WINGS

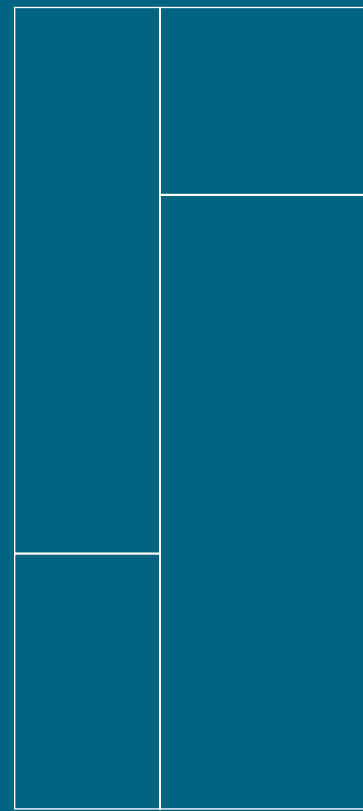

PROGRAMMA WALL RESINA

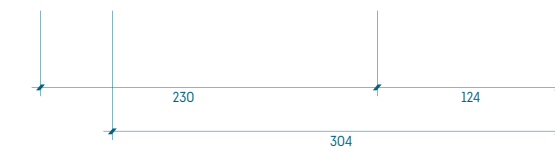
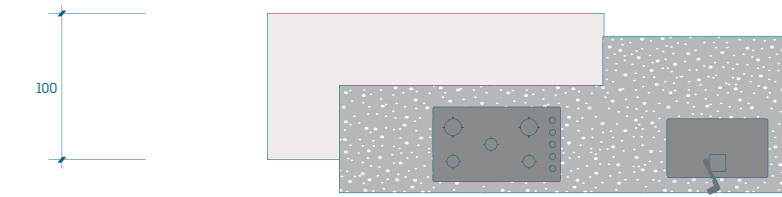
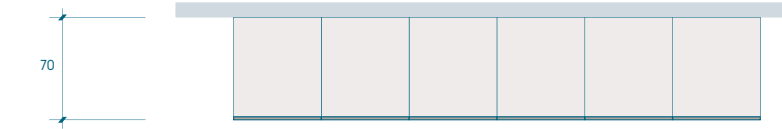
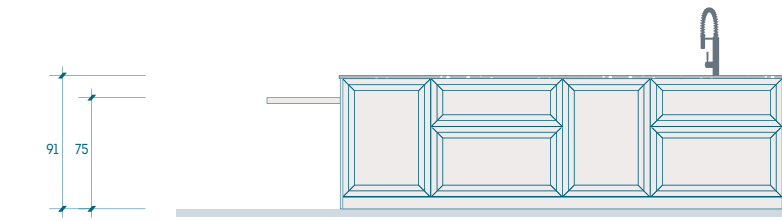
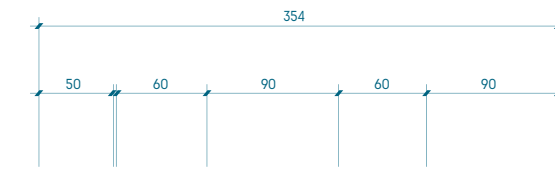
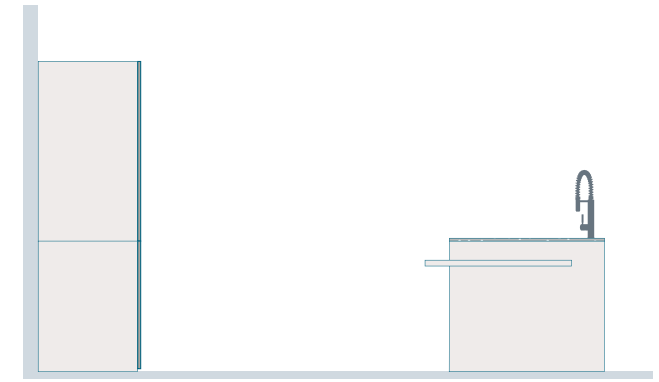
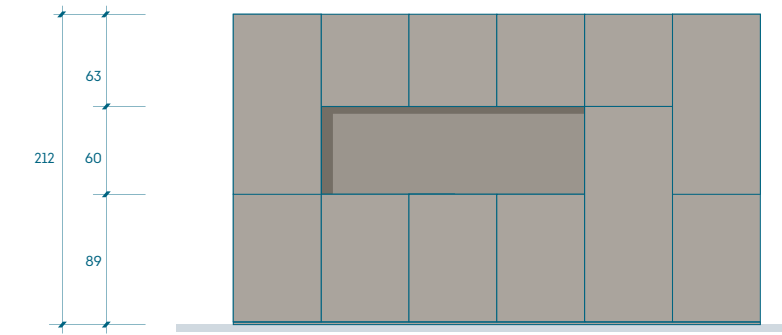
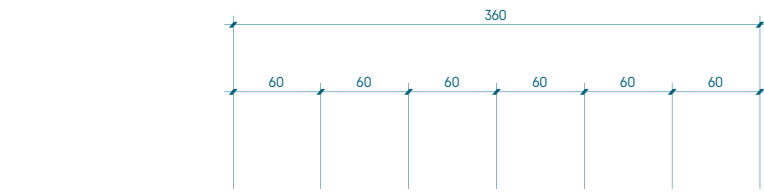

OGNI CUCINA TABULA
SI DISTACCA DALL'OVVIO
E DAL BANALE
E PRENDE FORZA
DALL'INSIEME DEI SISTEMI
E DELLE TECNOLOGIE
CON CUI È COMPOSTA,
SENZA LIMITI DIMENSIONALI
E COSTRIZIONI IMPOSTE
DAL SINGOLO MODELLO

PROGETTO



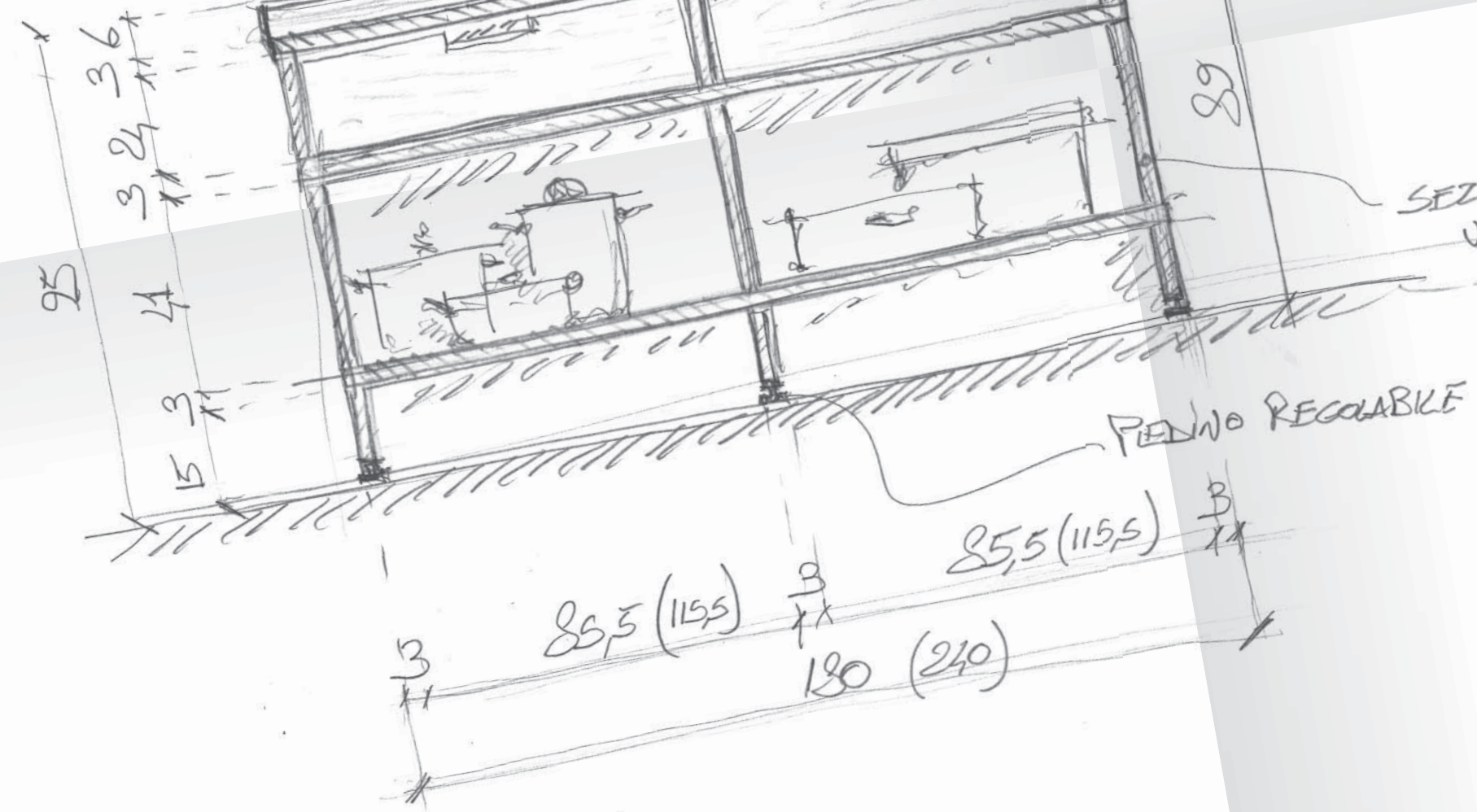
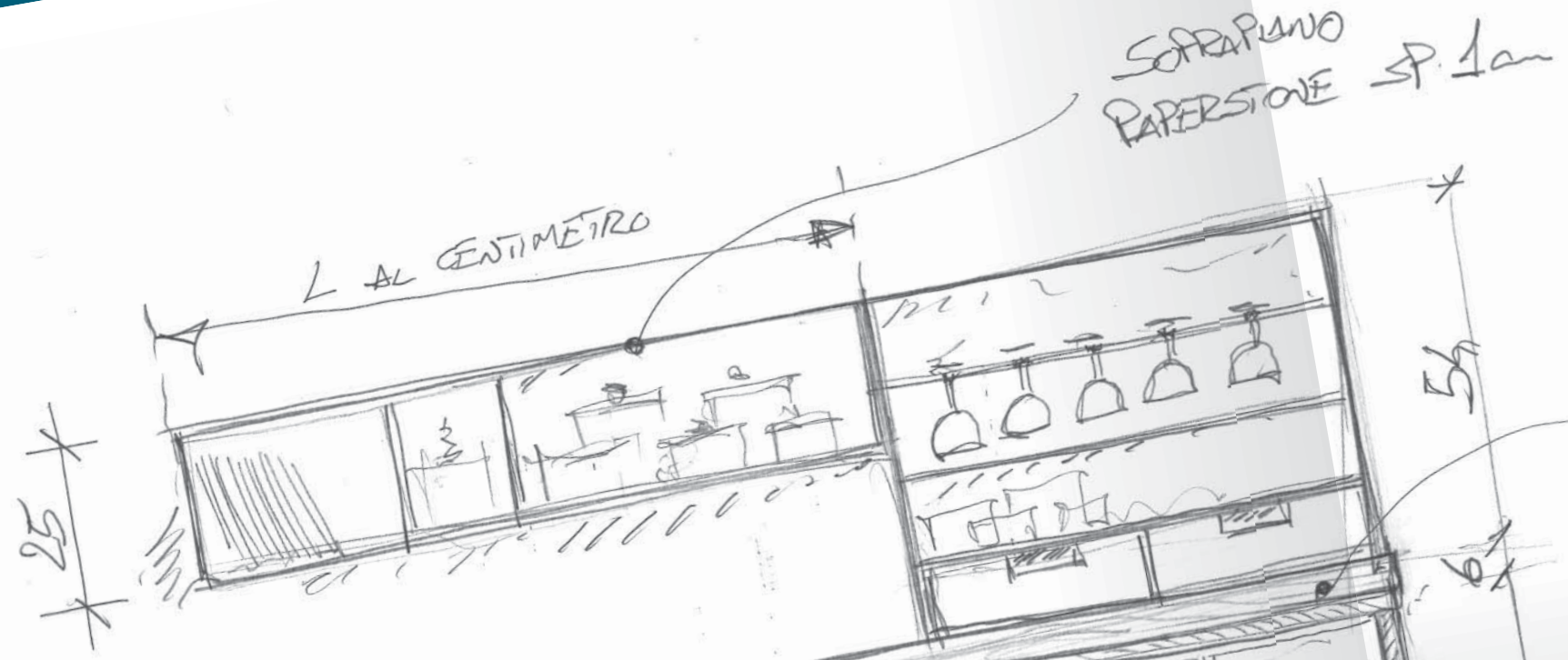

CASSETTONI IN LASSA

SEZIONE 3x3 FERRO VERNICIATO A POWERS

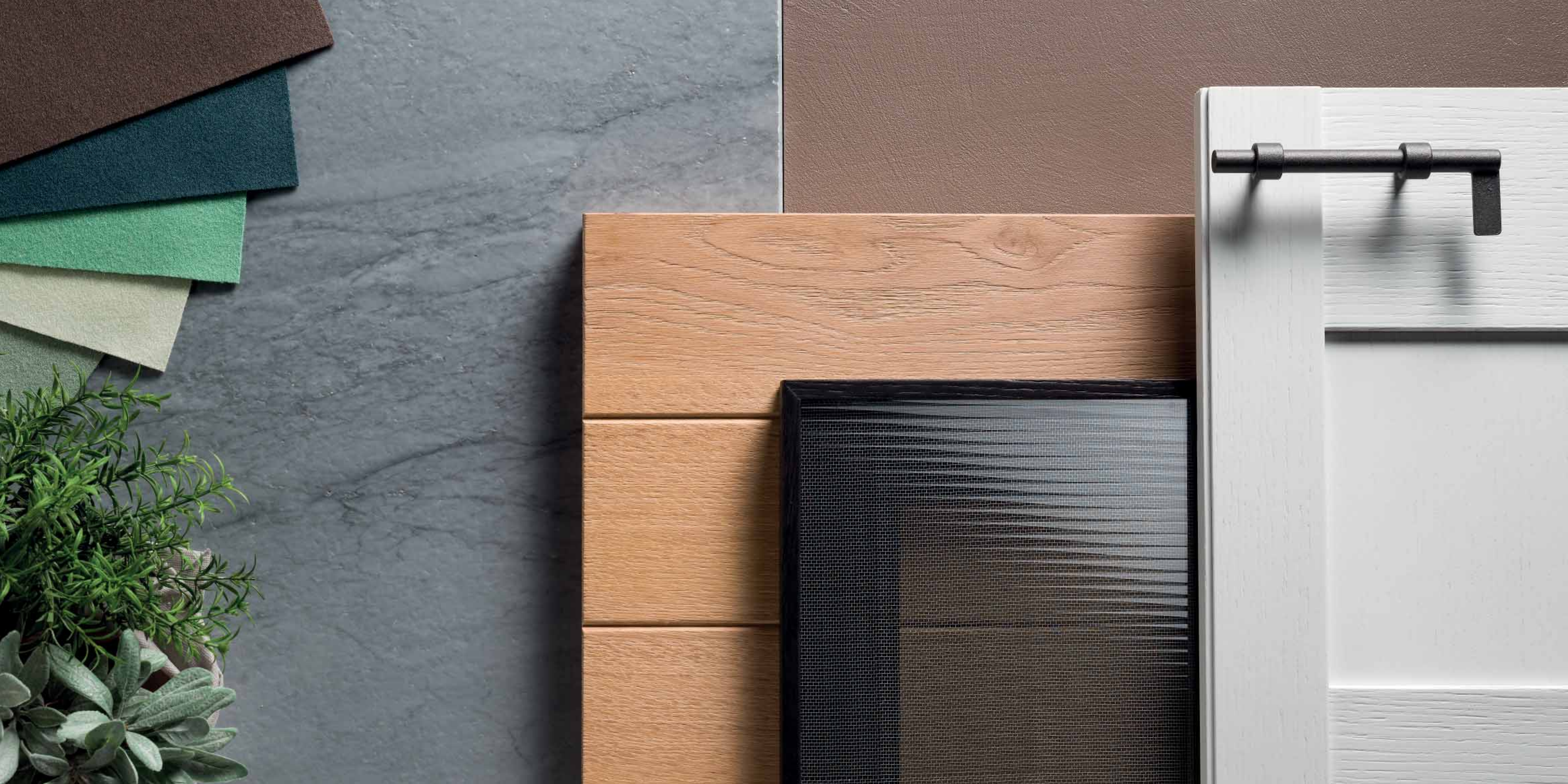



CRW



DOORS ROVERE LACCA MOBILI CUCINA
GLASS PROGRAMMA PENSILI VETRO
PIANO CHEF BLOCCHI IN PIETRA PER INCASSO COTTURA
CATENACCIO MANIGLIA IN FERRO



DOORS ROVERE LACCA MOBILI CUCINA
GLASS PROGRAMMA PENSILI VETRO



I BANCHI BANCO OPERATIVO IN FERRO
DOORS ROVERE LACCA MOBILI CUCINA





CRW



GLASS PROGRAMMA PENSILI VETRO





I BANCHI BANCO OPERATIVO IN FERRO





INTERNI MODERN FINITURA INTERNA IN LEGNO TINTO GRIGIO

I BANCHI BANCO OPERATIVO IN FERRO







MANIGLIA CATENACCIO

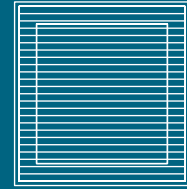

PROGRAMMA ANTA GLASS



PROGRAMMA SOPRAPIANO

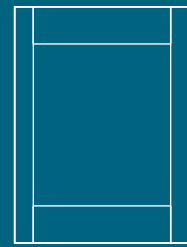

PROGRAMMA ANTA DOORS

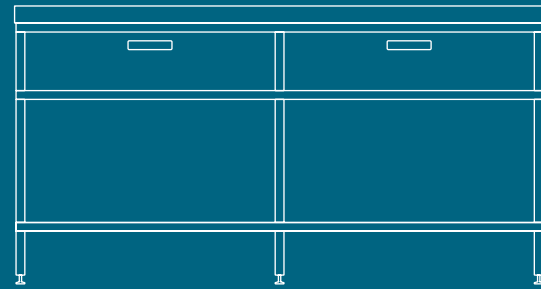

PROGRAMMA I BANCHI
L 120 / 180 / 240 CM
P 65 / 105 CM

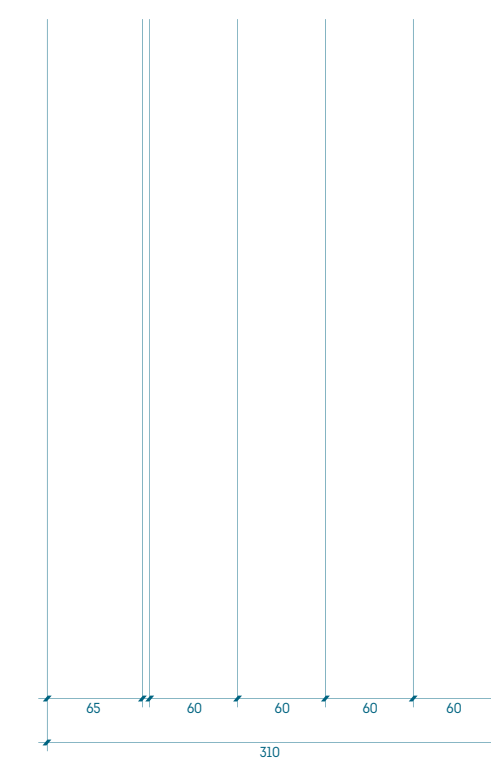
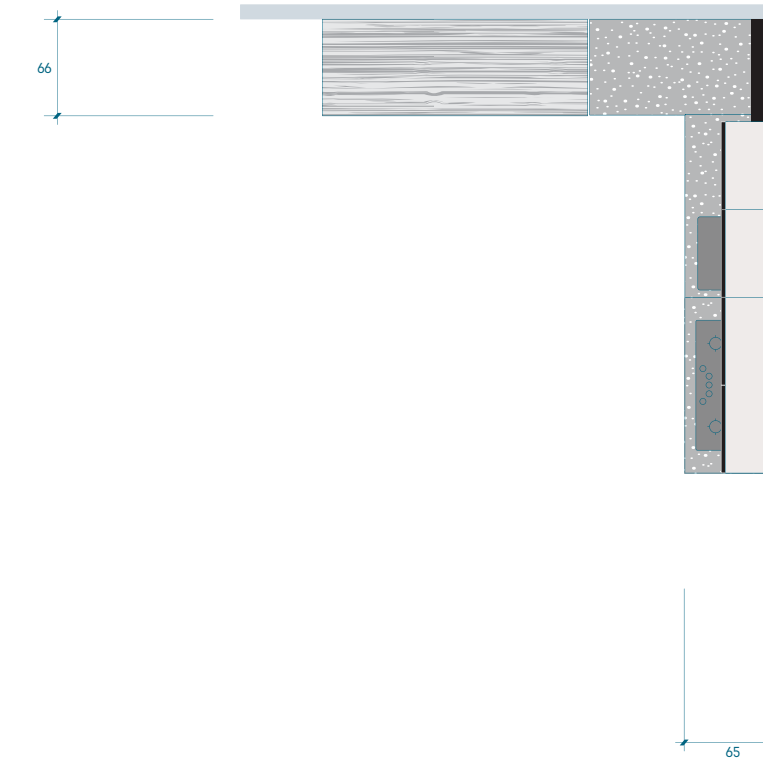
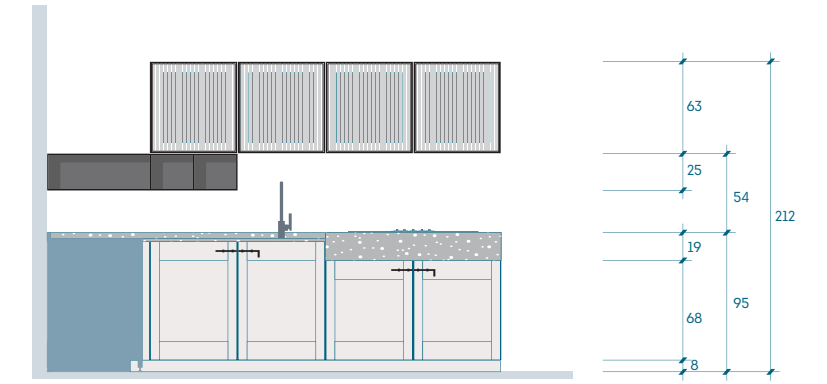
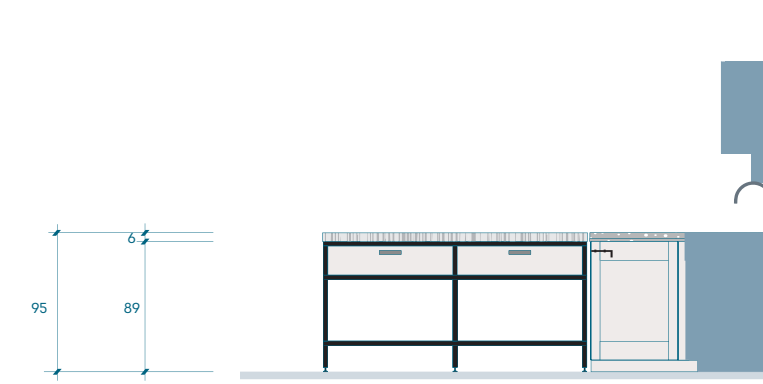
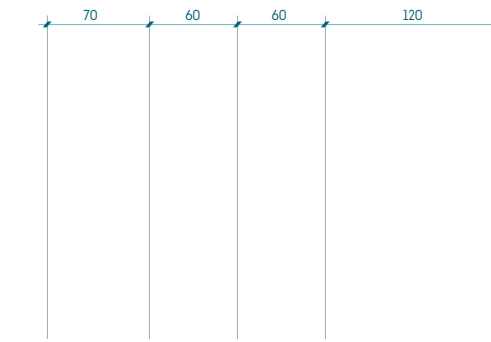
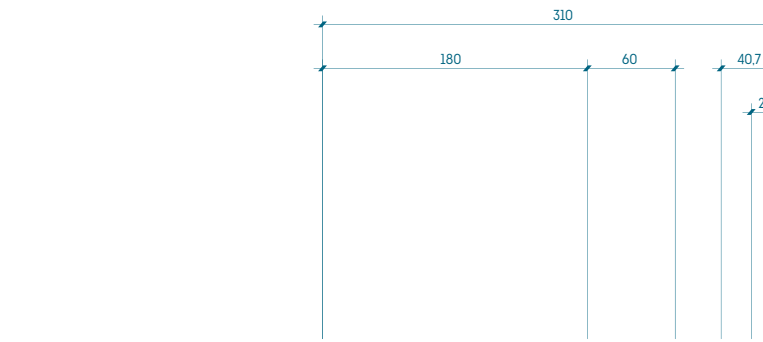

OGNI CUCINA TABULA
È OGGETTO DI UNA
PROGETTAZIONE DEDICATA,
DIVENTA UN'OPERA
IN CUI LA TECNICA E L'ASSOLUTA
MAESTRIA ARTIGIANALE
SI ESPRIMONO ALL'UNISONO
PER SODDISFARE PIENAMENTE
I TUOI DESIDERI

PROGETTO

07

MASSELLO DI CHICHERA
LATO INTERNO GAMBA

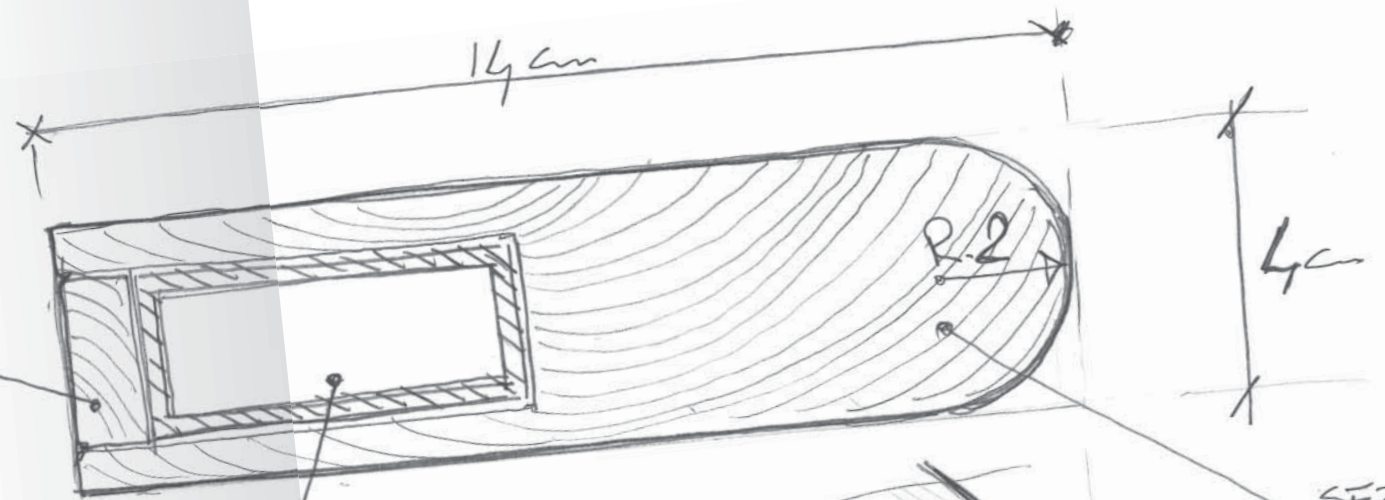

SEZIONE GAMBA
SCALA 1:1
MASSELLO LARICE/ROVERE

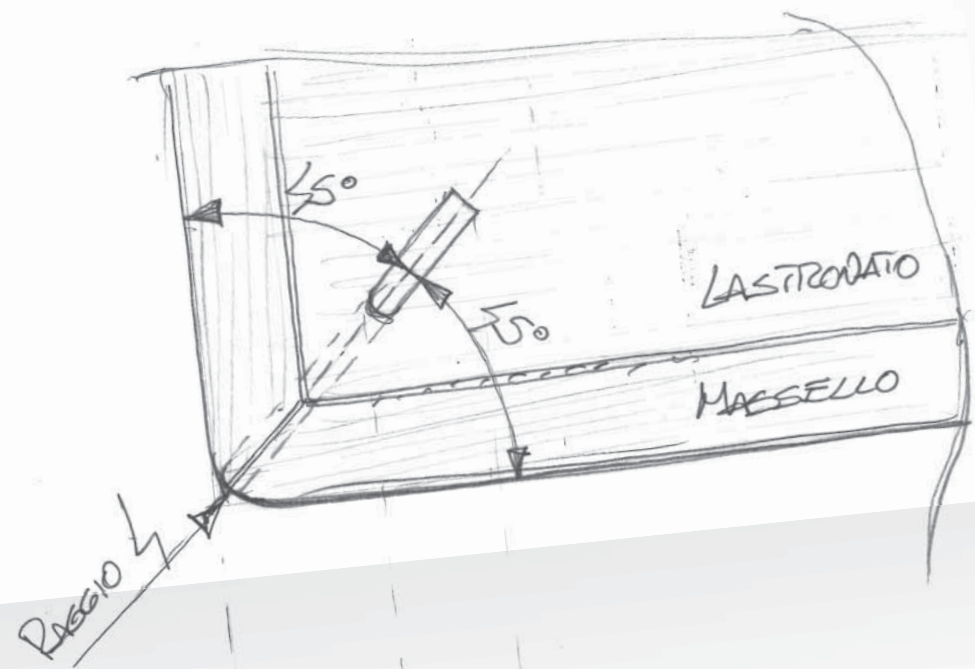

TUBOLARE IN FERRO 5x3
CON PIASTRA SP 05
MCCASSATA

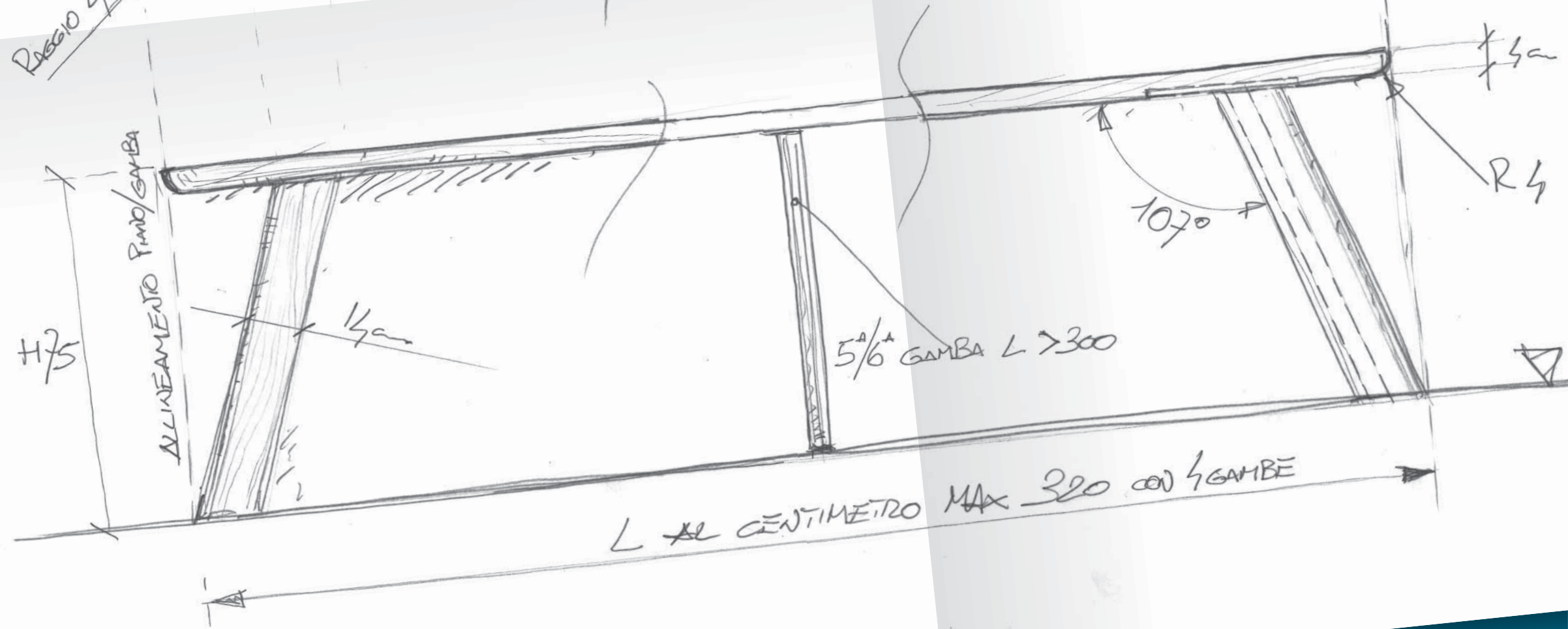
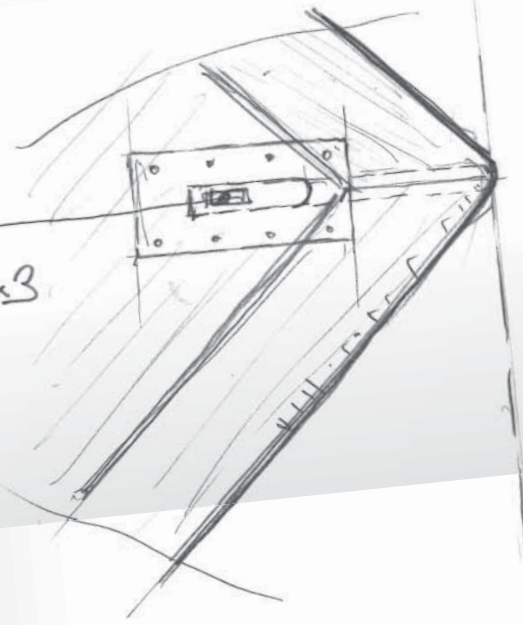

FABIO MOROSUO
05/02/2016

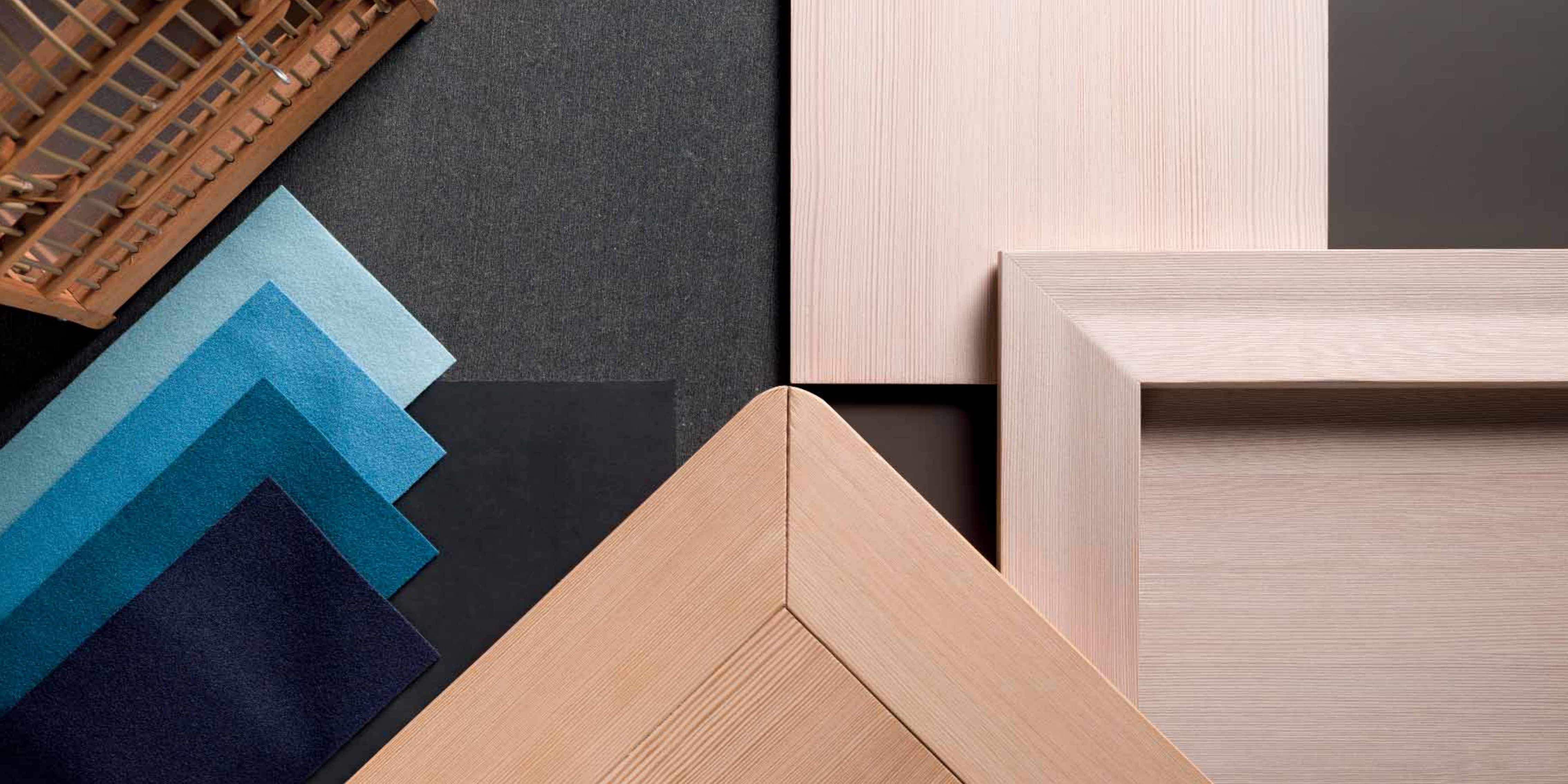



WINGS LARICE TINTO MOBILI CUCINA
PLAN LARICE TINTO MOBILI CUCINA
PRINT LAMINATO HPL MOBILI CUCINA
OSLO TAVOLO





OSLO TAVOLO





WINGS LARICE TINTO MOBILI CUCINA
PLAN LARICE TINTO MOBILI CUCINA
OSLO TAVOLO

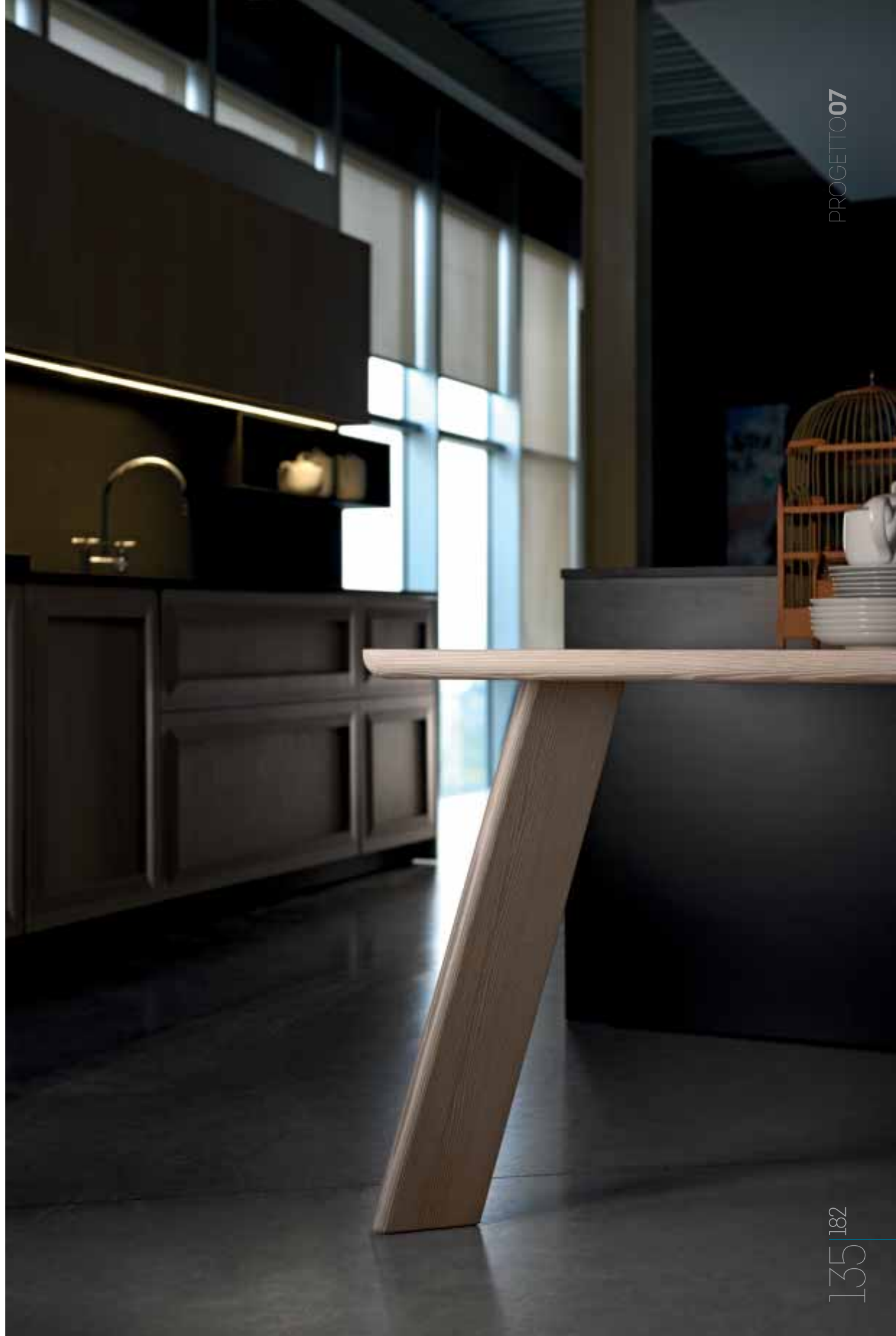





OSLO TAVOLO



PRINT LAMINATO HPL MOBILI CUCINA



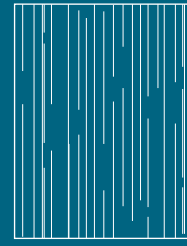

PROGRAMMA ANTA PLAN

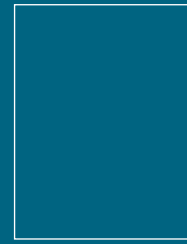

PROGRAMMA ANTA PRINT

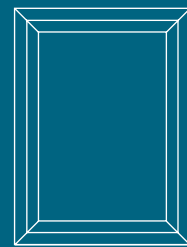

PROGRAMMA ANTA WINGS

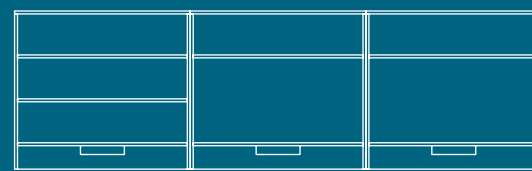

PROGRAMMA SOPRAPIANO

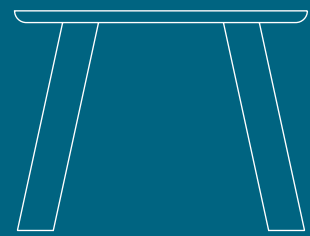

TAVOLO OSLO

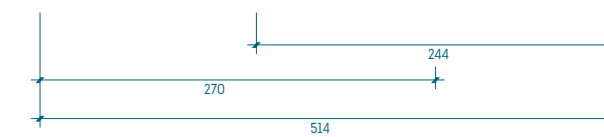
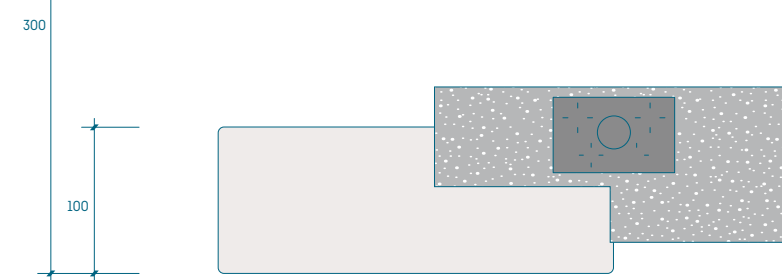
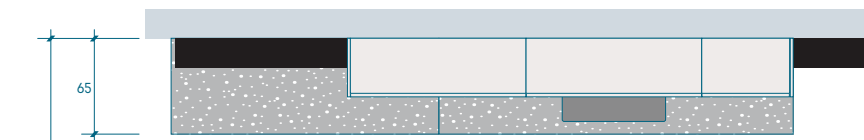
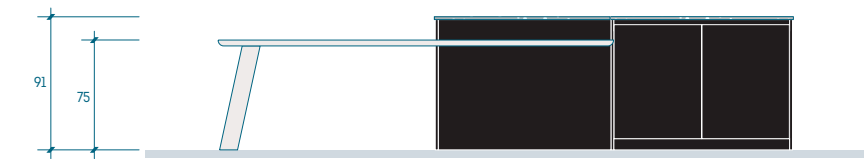
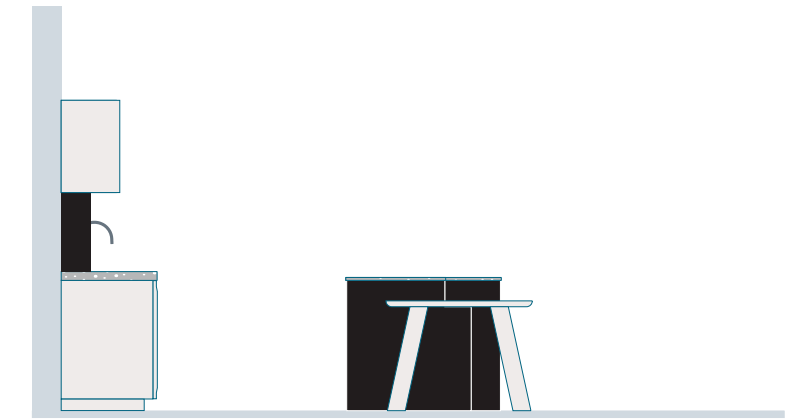
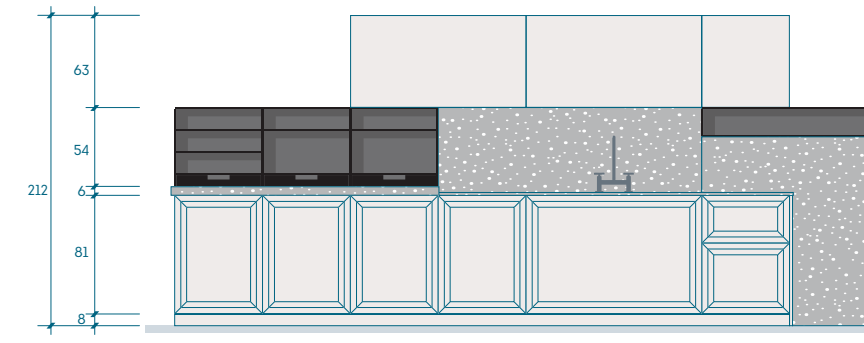
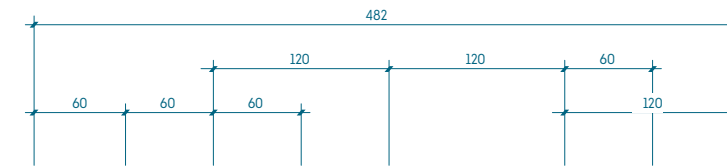

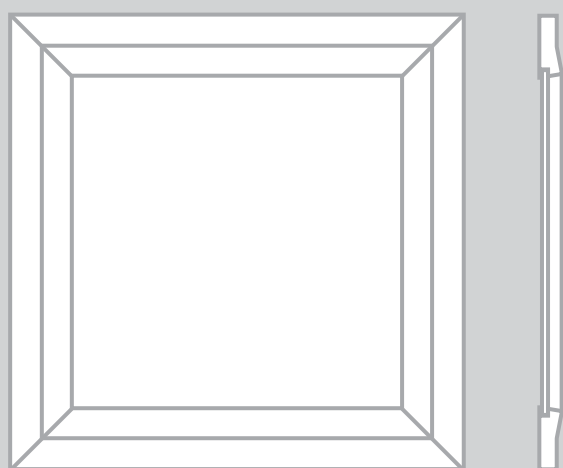

ANTA WINGS
LARICE - 11 FINITURE
ROVERE - 7 FINITURE
FINITURE RAL / NCS

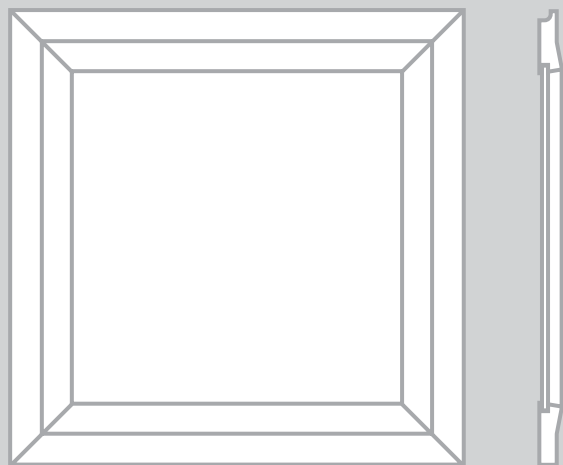

ANTA WINGS CON GOLA
LARICE - 11 FINITURE
ROVERE - 7 FINITURE
FINITURE RAL / NCS

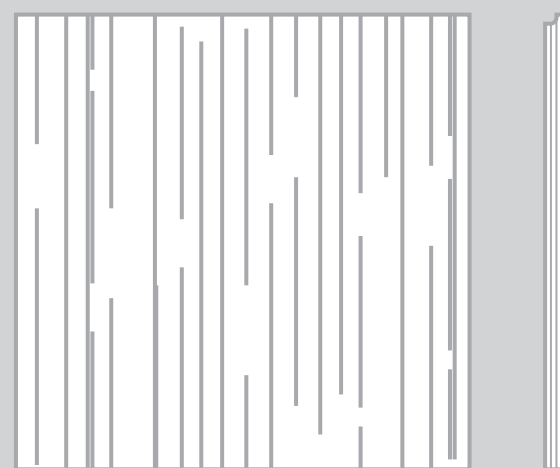

ANTA PLAN
LARICE - 11 FINITURE SU 3 STRATI
ROVERE - 7 FINITURE SU 3 STRATI
ROVERE NODATO
FINITURE RAL / NCS SU 3 STRATI



ANTA PRINT / FERRO
LAMINATO ABET HPL SU 3 STRATI
LAMINATO ABET POLARIS SU 3 STRATI
FERRO SU 3 STRATI



ANTA GLASS
TELAIO ESSENZE O LACCHE
VETRO ONDULATO + RETE METALLO + VETRO GRIGIO

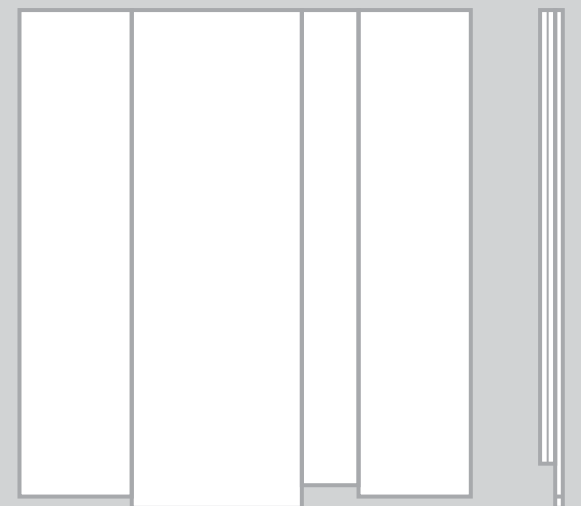

ANTA TAVOLE
ABETE GRIGIO 1' PATINA SU 3 STRATI
LARICE - 11 FINITURE SU 3 STRATI
ROVERE - 7 FINITURE SU 3 STRATI
ROVERE NODATO SU 3 STRATI

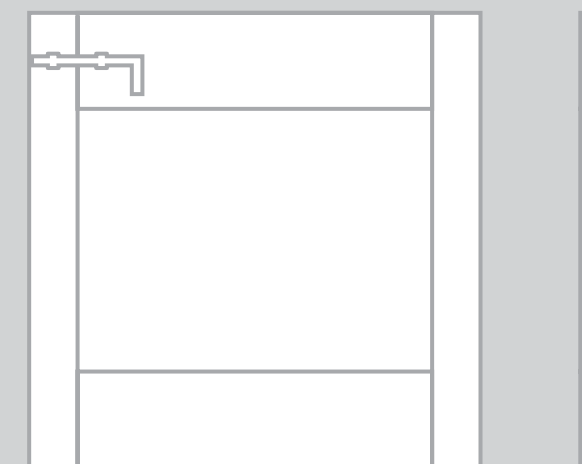

ANTA DOORS
ROVERE - 7 FINITURE
FINITURE RAL/NCS

APPUNTI
PER UNA VILLA
IN COLLINA

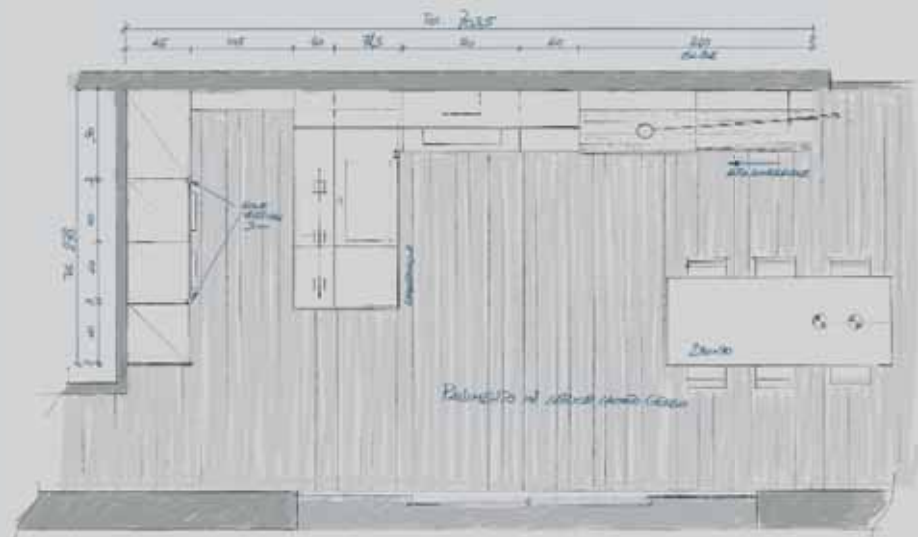

RISTRUTTURAZIONE
DI UN EDIFICIO RURALE
DI INIZIO SECOLO

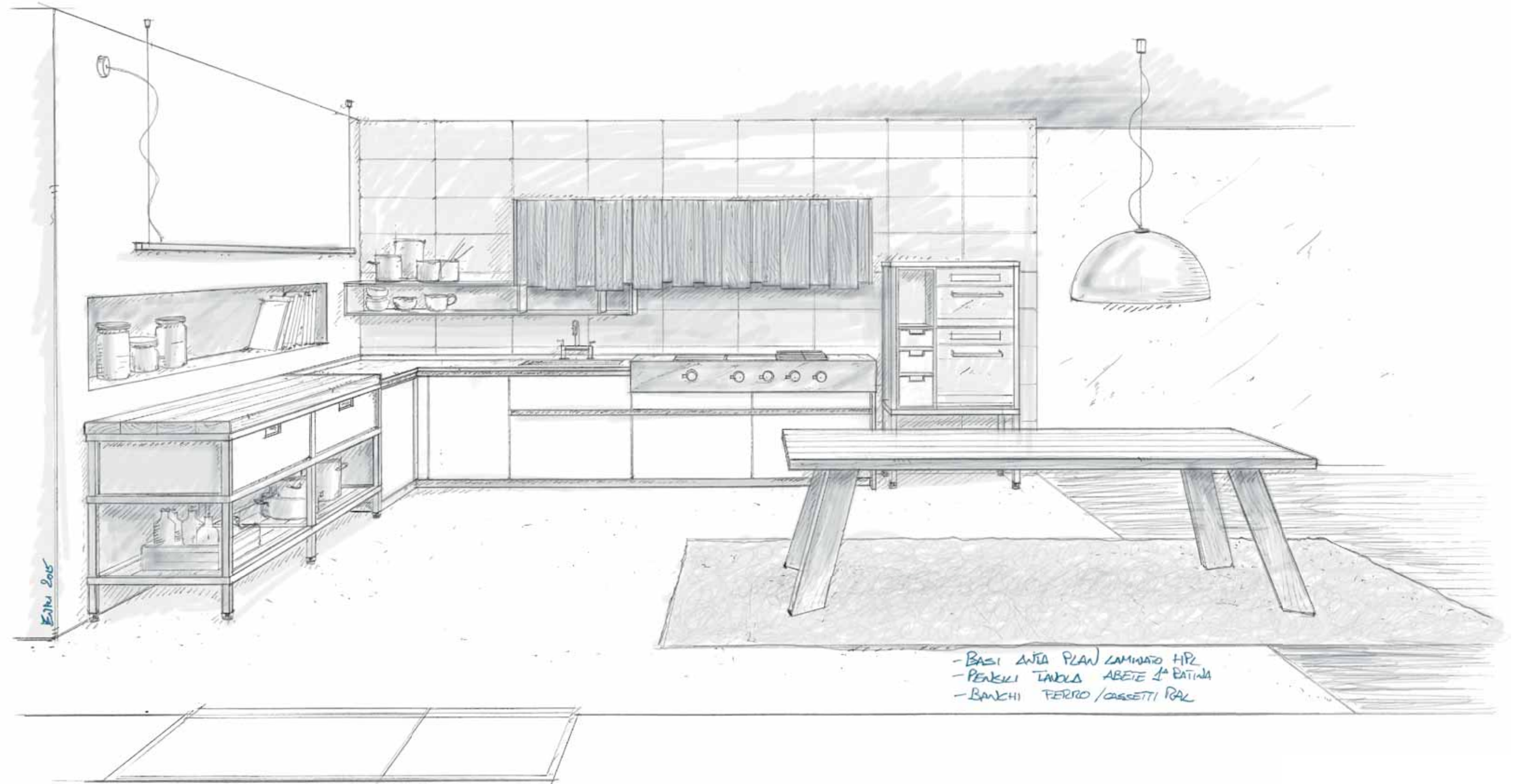
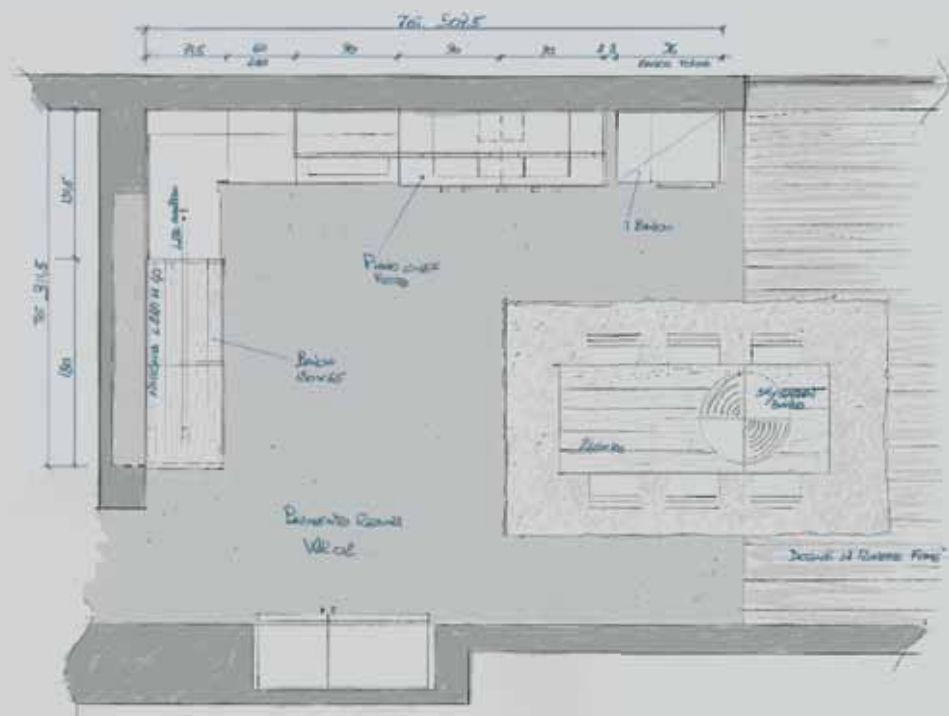

RECUPERO
DI UNA FABBRICA
DISMESSA

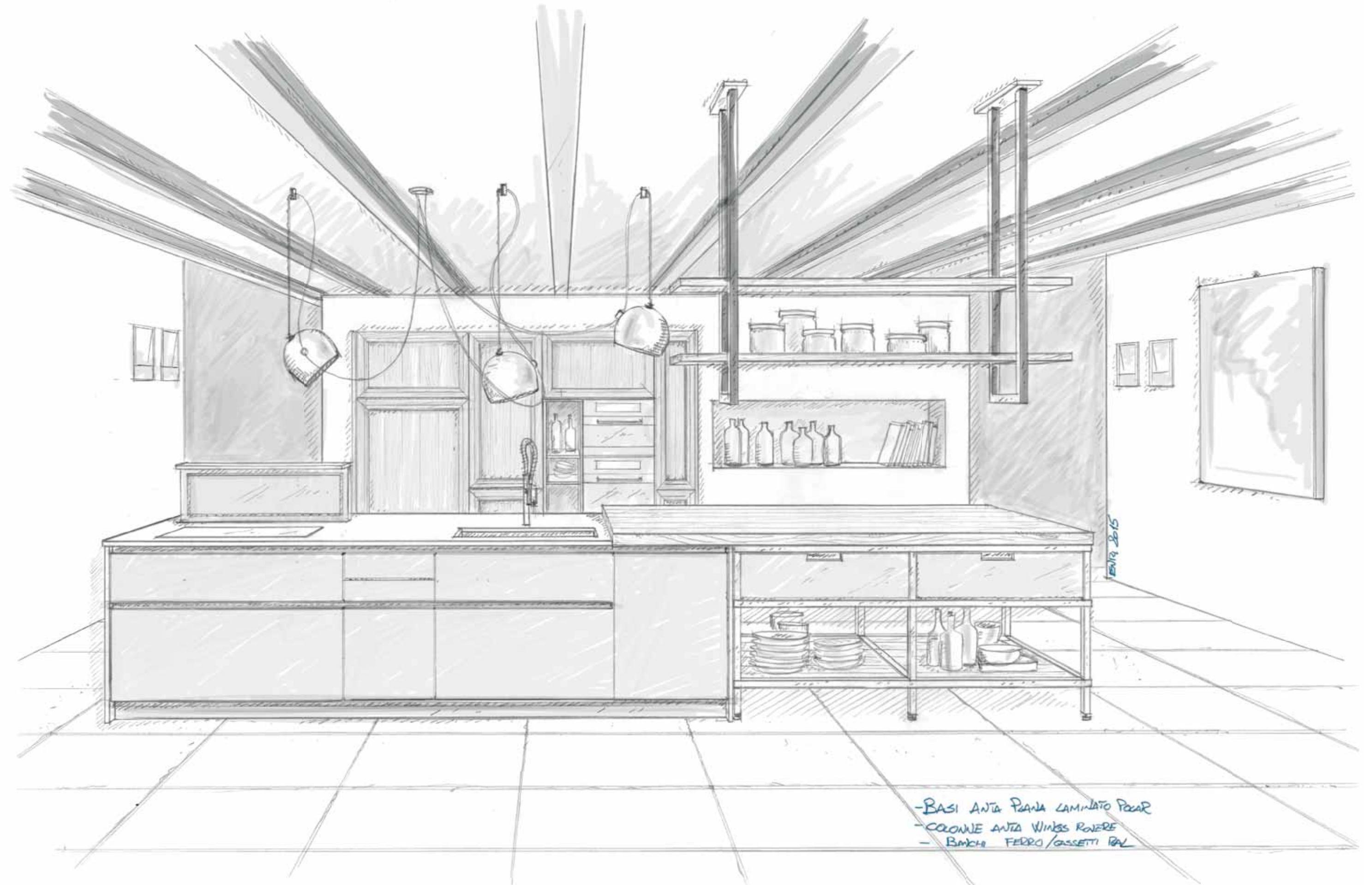

- BASI ANTA PIANA LAMINATO PEAR
- COLONNE ANTA WIMBS ROVERE
- BANCA FERRO/CASSETTI PAL

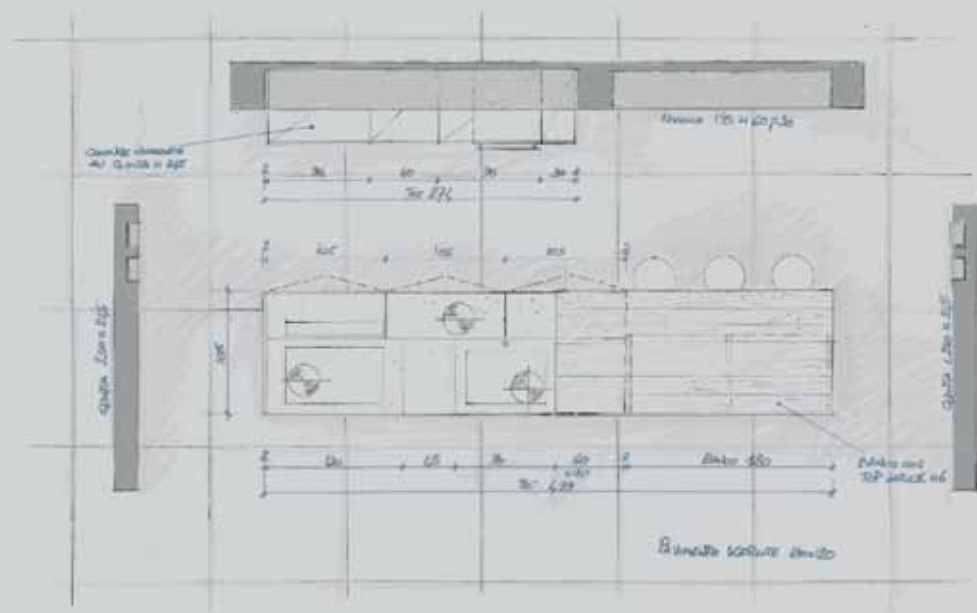

VILLA
SUL LITORALE
MEDITERRANEO

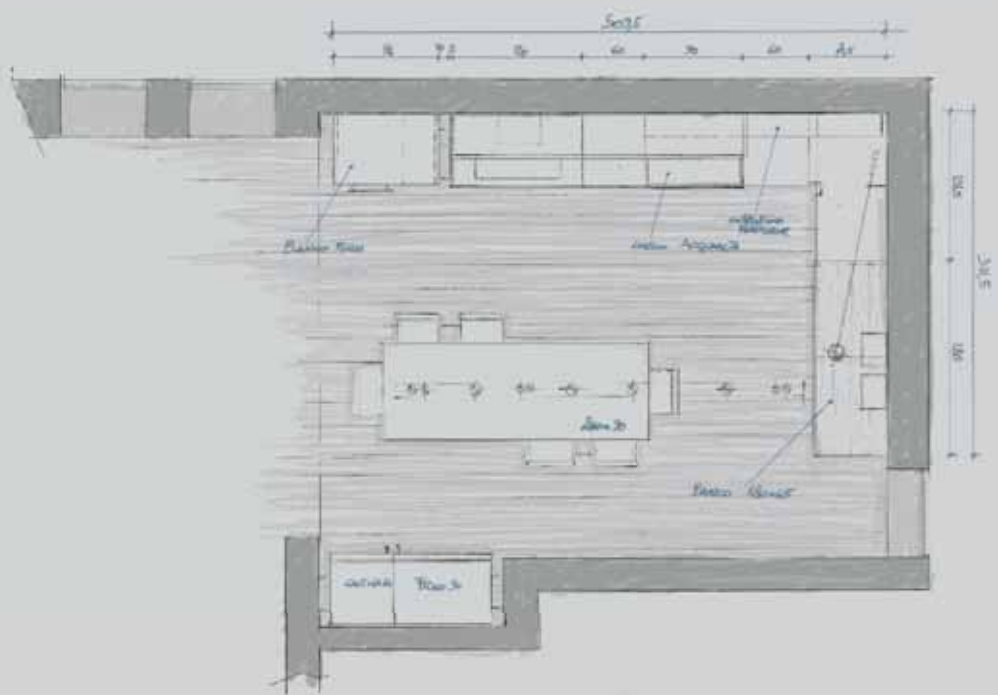

- BANCHI ANTA DOORS
- PENSILI ANTA GLASS
- BANCHI FERRO/CASSETTI RAL

PALAZZETTO
RINASCIMENTALE
IN CENTRO STORICO

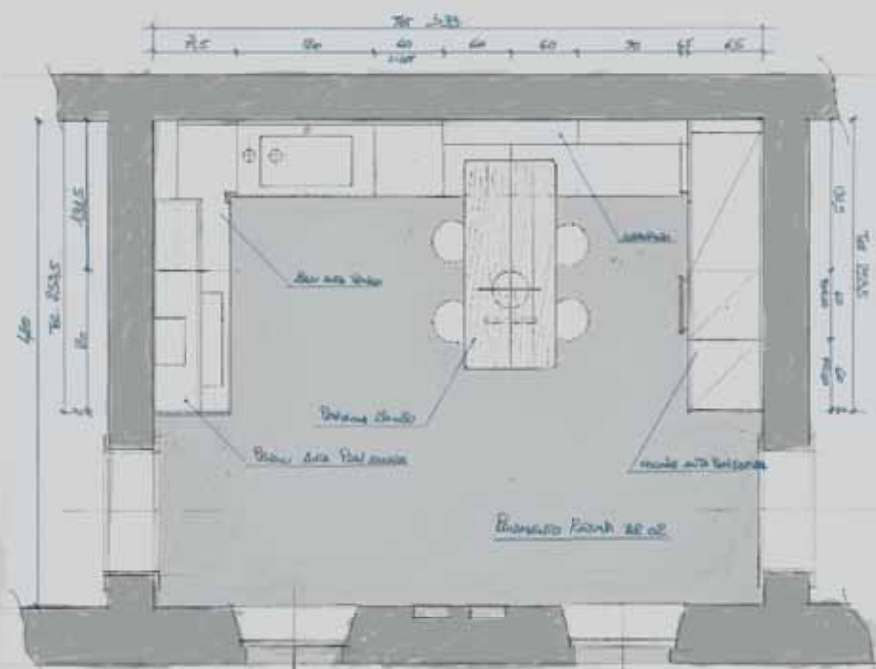

- BASI ANTA WINGS
- PENSILI ANTA PLAN ESSENZA
- COLONNE ANTA PLAN ESSENZA

ATTICO
SULLA 45ª STRADA

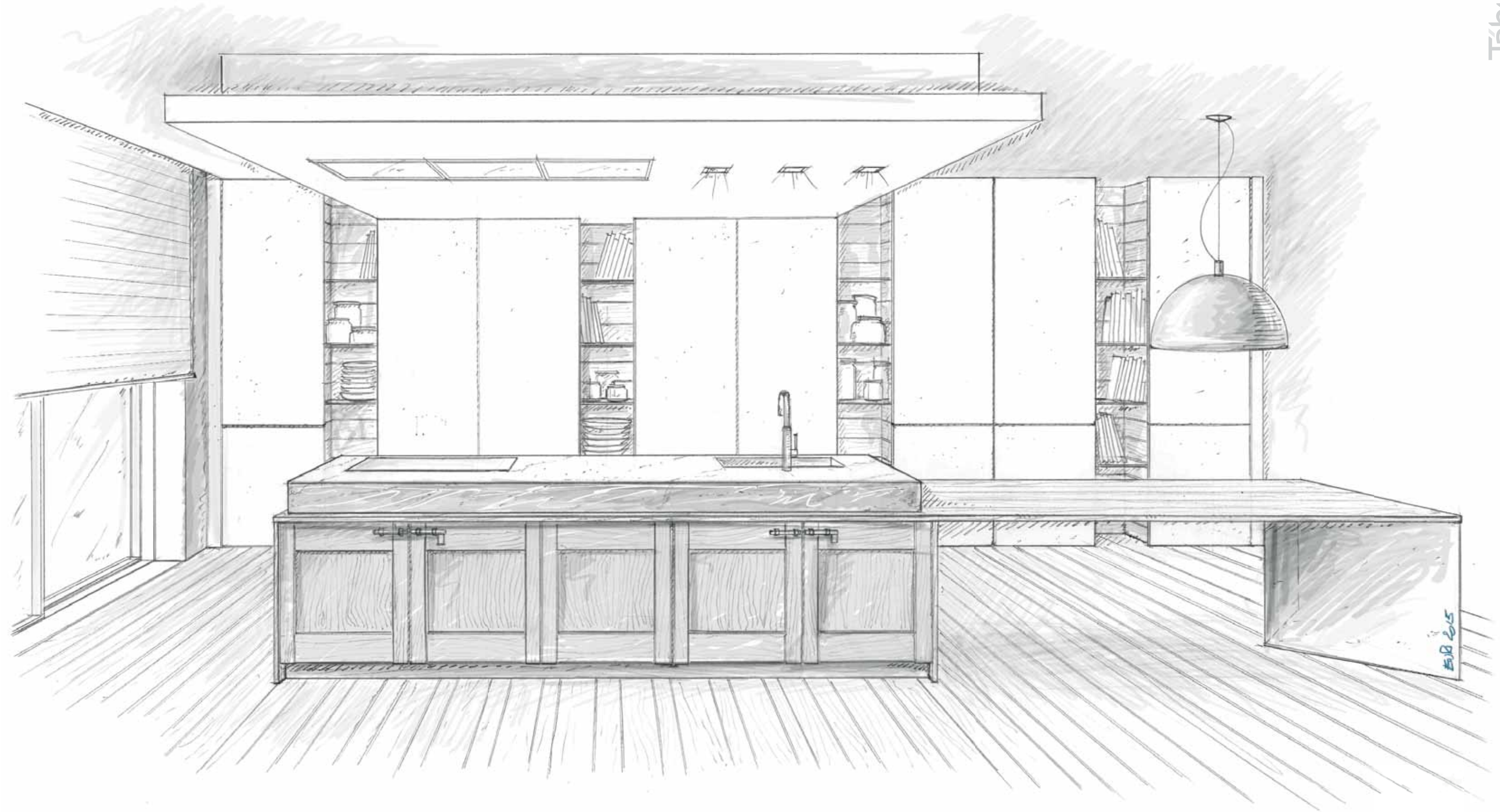
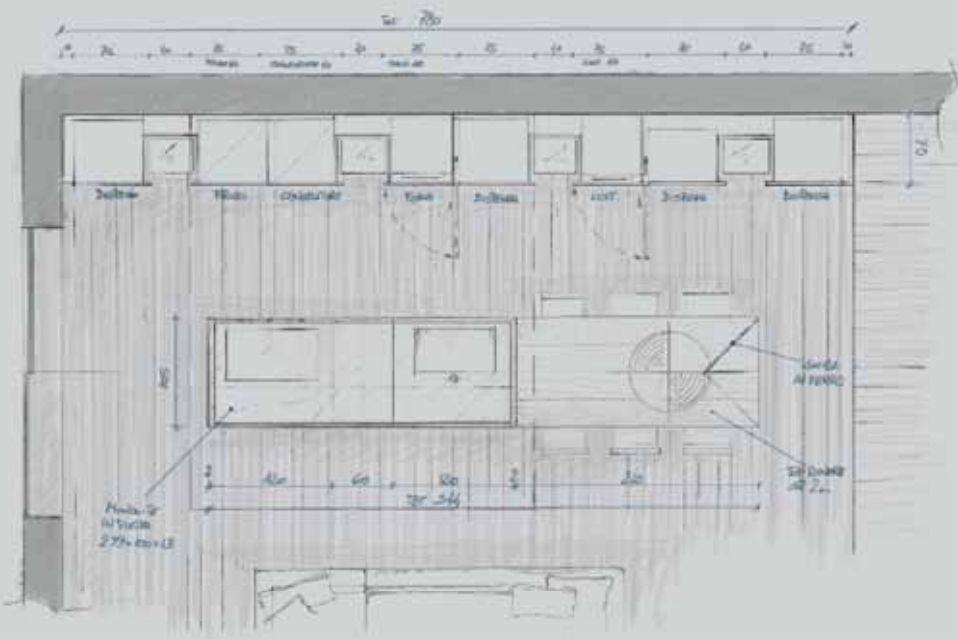

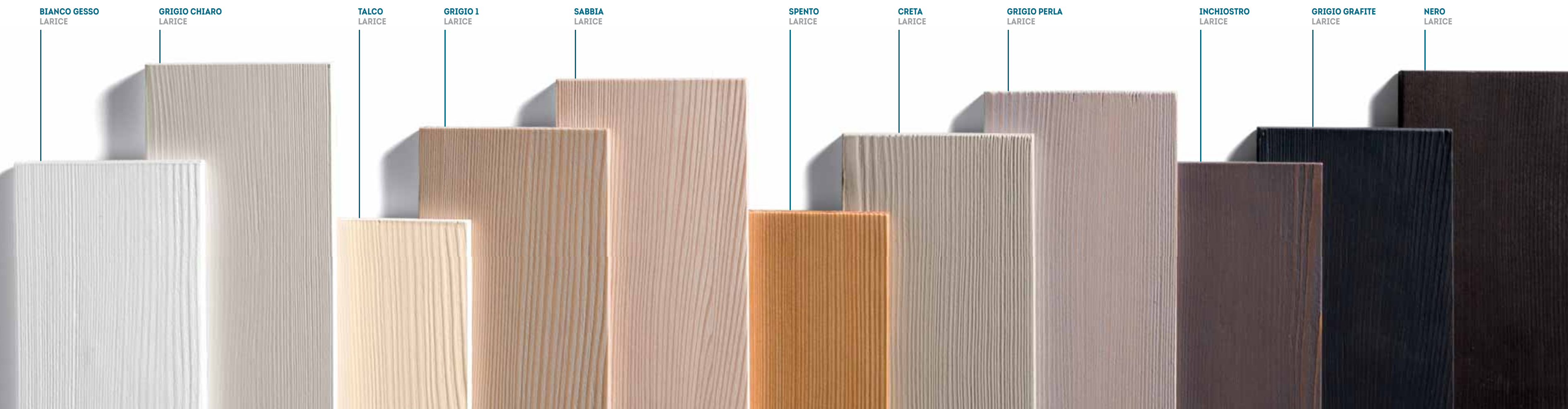

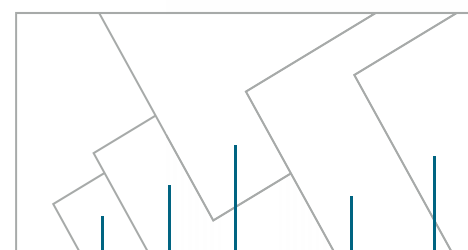

NERO ASSOLUTO

BARDIGLIO

PIETRA
PIASENTINA

BOTTICINO

QUARZITE GRIGIA



PAPERSTONE

VETRO

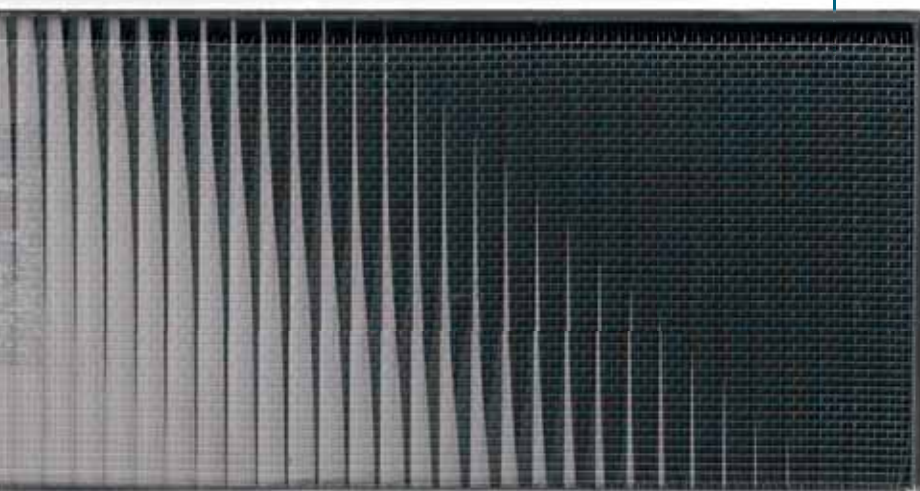

METALLO
ANTRACITE



METALLO
CHAMPAGNE



RESINA
WR10

RESINA
WR09

RESINA
WR08

RESINA
WR07

RESINA
WR06

RESINA
WR05

RESINA
WR04

RESINA
WR03

RESINA
WR02

RESINA
WR01

2904 BLANC GLACE
LAMINATO

2910 GRIS CLAIR
LAMINATO

2903 GRIS PERLE
LAMINATO

2907 GRIS FONCÉ
LAMINATO

2909 GRIS GRAPHITE
LAMINATO

2902 NOIR
LAMINATO

2905 GRIS COSMIQUE
LAMINATO

2906 GRIS MOYEN
LAMINATO

2908 SAHARA
LAMINATO

2901 SABLE POL
LAMINATO









NUOVE PATTUMIERE MODULARI
PER RACCOLTA DIFFERENZIATA
UTILIZZABILI ALL'INTERNO DI CESTONI
FINO A 120 CENTIMETRI



INTERNO ANTA WINGS
LA CORNICE COLOR ANTRACITE
È UTILIZZATA PER BLOCCARE
IL PANNELLO CENTRALE
SUL TELAIO DELL'ANTA STESSA



NUOVI PORTAPIATTI E STOVIGLIE
REALIZZATI IN FILO
PERSONALIZZATI COLOR TITANIO
UTILIZZABILI PER PENSILI
FINO A 120 CENTIMETRI



VASCA ASSEMBLATA ACQUAALTA

REALIZZABILE IN PIETRA
DIMENSIONABILE FINO A 120 CENTIMETRI
BORDO RIBASSATO
PER L'UTILIZZO DI TAGLIERI
O VASCHE SUPPLEMENTARI
IN APPOGGIO



STRUTTURE BASI H81

REALIZZATE IN LISTELLARE DI ABETE
PLACATO TANGANIIKA
PERSONALIZZATE CON TINTA ATOSSICA GRIGIA
DOTATE DI DUE RIPIANI INTERNI SPOSTABILI
ANTE PER STRUTTURE BASI H81
DOTATE DI TRE CERNIERE AMMORTIZZATE
PERSONALIZZATE COLOR TITANIO
GUIDE CESTI E CASSETTI
IN METALLO COLOR TITANIO



CAPPA FOGLIO

COSTRUITA CON LAMIERA DI FERRO
SPESSORE 3 MILLIMETRI, PIEGATA SEI VOLTE
DOMENZIONI 90-120-150
STRUTTURA ARRETRATA RISPETTO ALLA LAMIERA
REALIZZABILE IN LEGNO, IN QUALSIASI FINITURA
E PREDISPOSTA PER INSERIMENTO
DI DIFFERENTI ASPIRATORI



DESIGN ENRICO PASA

GRAFICA BASSODESIGN.IT

PH URNATO.IT

PRINT PAPERGRAF.IT

EDIZIONE 02 APRILE 2016

SI RINGRAZIA FPLARREDA.COM

TABULA PROGETTA E CREA

I PROPRI PRODOTTI

ESCLUSIVAMENTE IN ITALIA.

LA QUALITÀ PERSEGUITA DA TABULA

CREA IL CONTINUO MIGLIORAMENTO

CHE COINVOLGE TUTTE LE FASI,

DALLA PROGETTAZIONE

ALLA REALIZZAZIONE FINALE.

TABULA

VIA 1ª STRADA 26/28

36028 ROSSANO VENETO VI

T +39 0424 54 83 28

INFO@TABULACUCINE.IT

TABULACUCINE.IT



TABULACUCINE.IT

