

CREATIVE KITCHENS

Tábula

MANUALE DI VENDITA E VALORE

SERIE FRONTALI FRONT SERIES	PRINT	PLAN	METAL	TAVOLA	TAVOLA 1°PATINA	DOORS	WINGS	GLASS	WALL
TIPO ESSENZA TYPE ESSENCE		Rovere Rovere nodato Larice		Rovere Rovere nodato Larice	Abete	Rovere	Rovere Larice	Rovere	
MATERIALE/FINITURA MATERIAL/FINISCH									
IN ESSENZA		2		5	5	6	7		
LACCATO OPACO		2		5		6	7		
LAMINATO PRINT	1								
LAMINATO POLARIS	3								
TELAIO IN ESSENZA + VETRO RIGA CON MAGLIA METALLICA						8	7	8	
TELAIO IN ESSENZA + VETRO ACIDATO/STOP-SOL						6	7	7	
TELAIO IN ESSENZA + VETRO TRASPARENTE						6	7	7	
CON LAMINA IN FERRO			4						
CEMENTO RESINA									9

FRONTALI FRONT

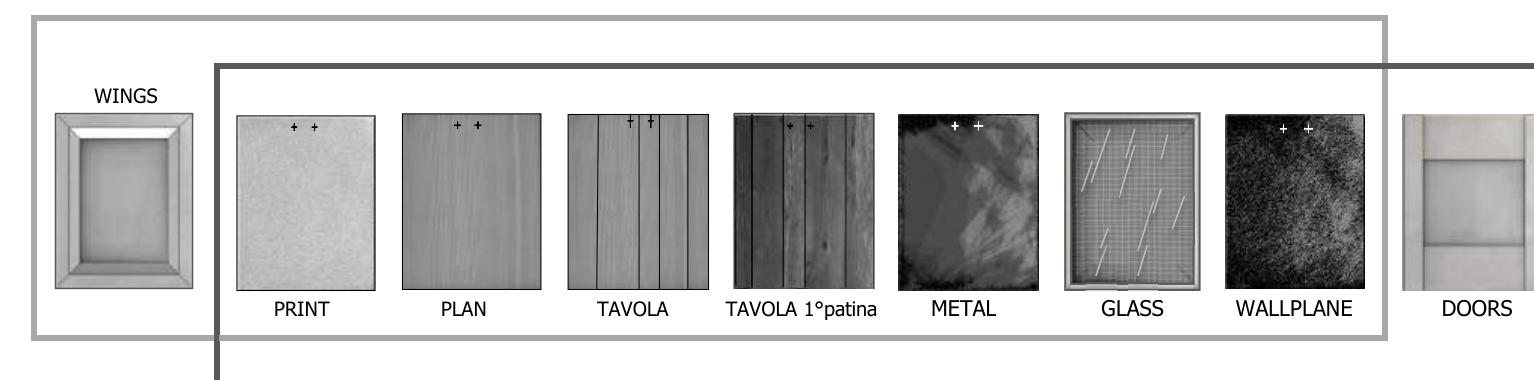

STRUTTURE STRUCTURES

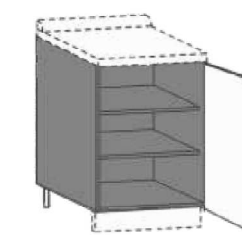

Fin. "Modern"

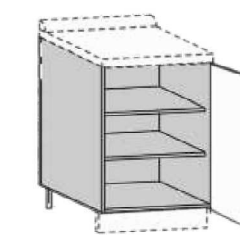

Fin. laccata/lacquered

CASSETTO DRAWER



Blum-Legrabox nero/black

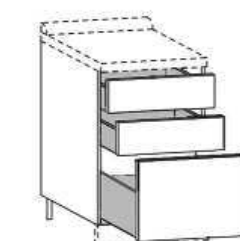

Legno/Wood + Blum-Movento

ZOCCOLO PLINTH

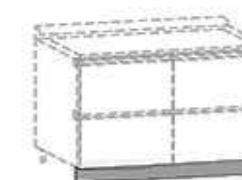

Essenza/Essence

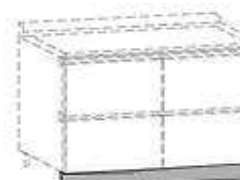

Metallo/Metal

GOLE O MANIGLIE GROOVE OR HANDLES

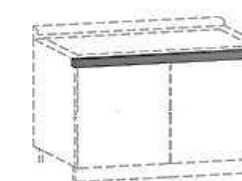

Gola in metallo/Metal groove

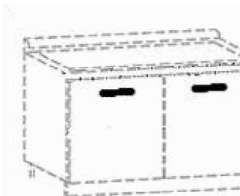

Maniglia/Handles

CERNIERE HINGES



Nero/Black



Nichelato/Nickel



TABULA PROGETTA E CREA
I PROPRI PRODOTTI
ESCLUSIVAMENTE IN ITALIA.
LA QUALITÀ PERSEGUITA DA TABULA
CREA IL CONTINUO MIGLIORAMENTO
CHE COINVOLGE TUTTE LE FASI,
DALLA PROGETTAZIONE
ALLA REALIZZAZIONE FINALE.

INDICE • INDEX

INFORMAZIONI

- L'AZIENDA E I PRODOTTI
- CARATTERISTICHE GENERALI
- NOTE PER LA PROGETTAZIONE

Pag. 4

INFORMATION

- COMPANY AND PRODUCTS
- GENERAL FEATURES
- NOTES FOR DESIGN

FRONTALI CUCINA

- WINGS
- DOORS
- TAVOLA
- TAVOLA 1°PATINA
- PLAN
- PRINT
- METAL
- GLASS

Pag. 9

KITCHEN FRONTS

- WINGS
- DOORS
- TAVOLA
- TAVOLA 1°PATINA
- PLAN
- PRINT
- METAL
- GLASS

BASI

- BASI
- BASI PER FORNO
- BASI PER LAVELLO
- FIANCHI PERSONALIZZATI E DI FINITURA

Pag. 27

BASE UNITS

- BASE UNITS
- BASE UNITS FOR OVEN AND HOB
- SINK BASE UNITS
- CUSTOM SIDES AND SIDES EXPOSED

COLONNE

- COLONNE H. 149
- COLONNE H. 212
- COLONNE H. 227/242
- FIANCHI PERSONALIZZATI E DI FINITURA

Pag. 43

TALL UNITS

- TALL UNITS HEIGHT 149
- TALL UNITS HEIGHT 212
- TALL UNITS HEIGHT 227/242
- CUSTOM SIDES AND SIDES EXPOSED

PENSILI

- PENSILI H. 48/63
- PENSILI H. 78/93
- PENSILI H. 123
- FIANCHI PERSONALIZZATI E DI FINITURA

Pag. 71

WALL UNITS

- WALL UNITS HEIGHT 48/63
- WALL UNITS HEIGHT 78/93
- WALL UNITS HEIGHT 123
- CUSTOM SIDES AND SIDES EXPOSED

MANIGLIE GOLE E ZOCCOLI

- MANIGLIE
- PROFILI GOLA
- ZOCCOLI

Pag. 83

HANDLESS GROOVE PLINTH

- HANDLESS
- GROVE PROFILE
- SIDES EXPOSED

CAPPE PERSONALIZZATE

- CAPPE PERSONALIZZATE
- ASPIRATORI

Pag. 89

HOODS CUSTOM

- HOODS CUSTOM
- VACUUM CLEANER

ELEMENTI COMPLEMENTARI

- PANNELLI
- PROGRAMMA "SOPRAPIANO" E "SOTTOPENSILE"
- PROGRAMMA "BANCHI IN FERRO"
- TOP ALZATINE E LAVELLI

Pag. 93

COMPLEMENTARY ELEMENTS

- PANEL
- "SOPRAPIANO" AND "SOTTOPENSILE" PROGRAM
- "BANCHI IN FERRO" PROGRAM
- SINK/TOP IN MARBLE

ACCESSORI INTERNI

- PATTUMIERE
- PORTAPOSATE
- ILLUMINAZIONE

Pag. 107

CABINETS ACCESSORIES

- BIN SYSTEM
- CUTLERY TRAY
- LIGHTING

PROGRAMMA "WALL"

- COLONNE DISPENSA "WALL"
- VANO A GIORNO SKY-FLOOR
- FIANCHI DI FINITURA

Pag. 111

"WALL" SERIES

- TALL LARDER UNITS "WALL"
- COMPARTMENT SKY-FLOOR
- SIDES EXPOSED

CALCOLO DEI PREZZI E CONDIZIONI GENERALI DI VENDITA

PREZZI E VALIDITA': Il presente listino prezzi è da considerare valido senza distinzioni per Nazione o area geografica. Per ognuno ogni prodotto sono indicate "unità di valore" e non prezzi di listino al pubblico in valuta. Per calcolare l'effettivo prezzo di listino si deve moltiplicare l'unità di valore o la loro somma, per il coefficiente assegnato dall'azienda al rivenditore. Solo in questo modo si possono ottenere i prezzi di listino al pubblico in Euro. I prezzi netti risultanti non sono comprensivi dell'aliquota IVA in vigore al momento della fatturazione. I prezzi praticati al rivenditore si intendono al netto di oneri fiscali straordinari, imposte, installazioni e di qualsiasi altra prestazione che sarà da ritenersi sempre a carico del committente.

Il presente listino al pubblico per i rivenditori entra in vigore dal giorno 1 settembre 2016 e sarà da ritenuto valido fino a successiva comunicazione. Gli ordini sono da considerare accettati solo dopo essere stati approvati della nostra Società. Eventuali errori, inesattezze ed omissioni che verranno riscontrati nel listino saranno tempestivamente comunicati al cliente.

*POSIZIONARE L'ETICHETTA FORNITA DALL'AZIENDA
CHE RIPORTA IL COEFFICIENTE DI LISTINO ASSEGNATO*

TRASPORTO: Il trasporto si intende franco destino, l'autotrasportatore non ha alcun obbligo di scaricare la merce in piani seminterrati, piani rialzati o a ulteriori livelli. La merce viaggia a rischio e pericolo del committente se venduta franco fabbrica.

INSTALLAZIONE: L'azienda declina ogni responsabilità in caso di errata o non corretta installazione dei propri prodotti e dei prodotti da lei commercializzati e in caso di utilizzo improprio degli stessi. Tutti i prodotti infatti vanno impiegati per il loro modo d'uso senza alterare le loro caratteristiche di origine.

FUORI MISURA: La richiesta di elementi fuori misura (articoli standard variati in una o più dimensioni) al di fuori di quanto già previsto a listino, deve essere valutata dall'azienda. Tali articoli saranno addebitati con una maggiorazione variabile a seconda della difficoltà di esecuzione. L'azienda non si ritiene responsabile dei materiali ed articoli fuori misura o non a listino, espressamente ordinati dal Cliente in quanto elementi unici, privi di verifiche strutturali e tecniche. Pertanto non si accettano contestazioni e resi. Le lavorazioni fuori misura non indicate a listino verranno valutate a preventivo.

CONFORMITA' AL CAMPIONE: La conformità al campione non deve intendersi in senso tassativo, dato che sussistono margini di tolleranza dovuti a variazioni del prodotto (colori, materiali, misure), causate da fattori ambientali (luce, umidità, ecc...) ed alla natura intrinseca dei materiali legnosi o lapidei le cui variazioni sono da considerarsi un pregio che caratterizza il prodotto. Per quanto concerne i prodotti commercializzati, vale la conformità al fornitore se citato a listino. Tuttavia in caso di difficoltà di approvvigionamento, dovute ad esempio a modifiche da parte della Casa costruttrice, l'azienda si riserva la facoltà di utilizzare prodotti con stesse caratteristiche funzionali e qualitative.

CONSEGNE: I termini indicati per la consegna possono subire variazioni per cause fortuite o per cause di forza maggiore; tali variazioni saranno comunque tempestivamente comunicate al cliente. Nessun danno diretto o indiretto può essere richiesto per mancata o ritardata consegna.

PAGAMENTO: Nessuna contestazione da parte del compratore potrà giustificare rifiuti o ritardi nel pagamento. Il ritardato pagamento, anche di una sola rata, autorizza l'azienda a richiedere il pagamento totale con l'addebito degli interessi di mora applicati al tasso bancario vigente. Clausola di riserva della proprietà: i beni consegnati e fatturati rimarranno di nostra esclusiva proprietà fino al completo pagamento del documento di riferimento.

GARANZIA: La garanzia sul prodotto si intende quella stabilita dalla legge. Per i prodotti commercializzati (cappe, lavelli, elettrodomestici, ecc...) ovvero di fornitura esterna, dovranno essere fatti valere, ove esistenti, i certificati di garanzia dei costruttori. L'azienda inoltre non si ritiene responsabile per un errato utilizzo degli articoli prodotti e forniti.

RESI: E' compito del committente di verificare accuratamente il prodotto all'atto della consegna e comunicare formalmente all'azienda entro 8 giorni (otto) gli eventuali difetti riscontrati. In quel caso la stessa, previa autorizzazione a rendere il materiale in sede, si fa carico di effettuare un'attenta verifica allo scopo di appurare natura e responsabilità del difetto. Condizione necessaria inoltre è che il committente provveda a rendere il materiale sempre ed esclusivamente con il suo imballo entro 20 giorni dalla consegna.

LISTINO: La rappresentazione grafica dei moduli e delle tinte presentati a listino, sono da ritenersi indicativi e non vincolanti nei dettagli. Il presente listino ha validità fino a comunicazione contraria da parte dell'azienda che inoltre si riserva di apportare in qualsiasi momento e senza preavviso, le modifiche ritenute opportune al fine di migliorare le caratteristiche qualitative e tecniche della propria produzione. In ogni caso, verranno mantenute le medesime caratteristiche di funzionalità e il loro modo d'uso. Dal momento dell'acquisizione dell'ordine si avvia tutta la procedura contrattuale che porta l'azienda ad inviare al cliente la conferma d'ordine che dovrà essere restituita firmata per accettazione; solo da quel momento, partirà la programmazione della produzione e consegna. Ad ogni successiva variazione dell'ordine, dovrà corrispondere un nuovo invio di conferma d'ordine. Non verranno accettate modifiche all'ordine dopo che lo stesso sarà avviato alla produzione. L'azienda si riserva il diritto di apportare modifiche al prezzo di vendita anche in data successiva all'arrivo dell'ordine.

FORO COMPETENTE: Ad ogni effetto legale e per qualsiasi controversia derivante dal rapporto, le parti eleggono come foro competente quello di Vicenza - Italia.

CALCULATION OF THE SELLING PRICE AND GENERAL BUSINESS CONDITIONS

VALIDITY: This price list is valid without distinctions of countries or geographic areas. To each product correspond "units of value" and not public list prices in currency. In order to calculate the list price you have to multiply the unit of value or the summation by the coefficient assigned to the dealer by the company. In this way you can have the public list prices expressed in Euro. All prices does not include VAT at the billing. The prices charged to the dealer are intended after tax, installations and any other service which will be at the customer's expense.

This price list is valid from the 1st September 2016 and supersedes all previous lists. Orders have to be accepted by the company. An error, or omission found in the price list will be immediately communicated to the customer.

*PLACE THE LABEL GIVEN BY THE COMPANY
WHICH INDICATES THE LIST COEFFICIENT ASSIGNED*

TRANSPORT: All goods travel at the buyer's risk and peril if sold EX WORKS.

FITTING: The company cannot be held responsible for any longer error made during the installation of its products, of the products sold through, or for any case of improper use.

SAMPLE CONFORMITY: The sample conformity is not to be considered absolute, as there are margins of tolerance due to product variation (colours, material, dimensions), due to environment factors (light, humidity etc...), and to the very nature of all wooden materials, whose variation must be considered as a quality. For the merchandised products it is the supplier's conformity, to be valid if mentioned on the price list. In case of difficult procurement, due for example to modification of the supplier, Tabula reserves the right to use products with the same function and quality features at the best of it's ability.

DELIVERY TIME: The company will make all reasonable attempts to supply goods ordered within the usual delivery time. In case of delays or cancelled delivery due to unforeseen circumstance beyond Tabula's control, the customer will be immediately informed. Tabula will not accept claims for compensation. Tabula keep the property of the good until the full payment of the invoices.

SPECIAL ITEMS: If possible Tabula manufactures special items according to instructions on orders, with an additional surcharge on to the item price according to difficulty. Tabula is not responsible for the items which are not standard or not in the price list and which are ordered on demand because they are unique items, without structural and technical control. Therefore disputes and returns will not be accepted for these items. Special not indicated in the price list will be estimated case by case.

PAYMENT: No claim will justify non-payments or delay on payment. The delayed payment will authorise Tabula to ask for the total payment with interests for the delay calculated on bank rates in force. The buyer acknowledges its cosent before delivery of the goods. The buyer acknowledges being informed to the above terms and conditions in writing prior to delivery of the goods. Clause of property's reservation: delivered and invoiced goods remain our exclusive property until the complete payment of the document in question.

GUARANTEE: The guarantee on product is that fixed by the law. For merchandized products (hoods, sinks, appliances, etc...) or all the outer ss the guarantee certificate of each single supplier, where existing, is valid. Tabula is not responsible for a non proper use of items manufactured or provided by the company.

RETURNED GOODS: The buyer must check the goods carefully and inform Tabula of any claim within 8 (eight) days. Tabula authorises the buyer to return the goods and verifies it to ascertain the nature and responsibility of the claim. The buyer must send back the claimed goods packaged within its own carton only within 20 days of delivery.

PRICE LIST: The unit drawings and the colours which appear in the price list are to be considered approximate and not binding for what concerns the details. The current price list is considered valid unless differently communicated by Tabula. Moreover Tabula reserves the right to carry out any necessary change at any time and without previous notice in order to improve the qualitative and technical features of its production. At any rates the functional characteristics and the usage of the item will be maintained. From the moment Tabula receives the order the contractual procedure begins and the company sends the customer a confirmation of the order itself which will have to be returned signed as proof of acceptance. The production and delivery process begins only from that moment. Every subsequent variation to the original order will have to be accompanied by a new confirmation of the order. Once the production process has started, no variation to the order will be accepted. Tabula reserves the right to modify the sales prices even after the date the order is received.

PLACE OF JURISDICTION: Place of jurisdiction for any litigation is mutually agreed to be Vicenza - Italy.

L'AZIENDA • COMPANY



CHI SIAMO

La storia di Tabula inizia dall'incontro tra il designer Enrico Pasa e Trento & Bizzotto. L'azienda nasce a metà degli anni ottanta a Rossano Veneto, a pochi chilometri da Bassano del Grappa, importante distretto per la costruzione di mobili e arredi. L'intraprendenza e la capacità dei due soci, ha portato la ditta a costruire le prime cucine. Dalla fine degli anni ottanta, l'impresa ha una presenza costante sul territorio nazionale attraverso una rete vendita. La fine degli anni novanta coincide con l'apertura dell'attuale sede produttiva di circa 2500 metri.

WHO WE ARE

The story of Tabula starts from the encounter between the designer Enrico Pasa and Trento & Bizzotto. The firm was founded in the 80s in Rossano Veneto, a small village a few kilometers far from Bassano Del Grappa, important district for the construction of furniture and furnishings. The enterprise and talent of the two partners led the company to produce their first kitchens. Since the late eighties, the company offers a constant presence in the country through a large sales network. The late nineties coincide with the opening of the operational headquarters of approximately 2500 meters.

MISSIONE

Lo spirito del progetto Tabula nasce dalla volontà di costruire senza più essere costretti a svuotare un'idea per dover accettare compromessi imposti da convenzioni, convenienze, abitudini e preconcetti. Abbiamo creato un insieme di sistemi aperti, di programmi con forte identità, capaci di dialogare tra loro con la massima flessibilità dimensionale, materica ed estetica, per dare concretezza alle visioni di chi ama progettare.

MISSION

The spirit of the project Tabula arises from the thought of not being forced to empty an idea in order to accept compromises imposed by conventions and preconceptions. We have created a set of open systems and programs with strong identity, able to talk to each other with the highest dimensional, material and aesthetic flexibility. With the aim of giving substance to the ideas of those who love design.

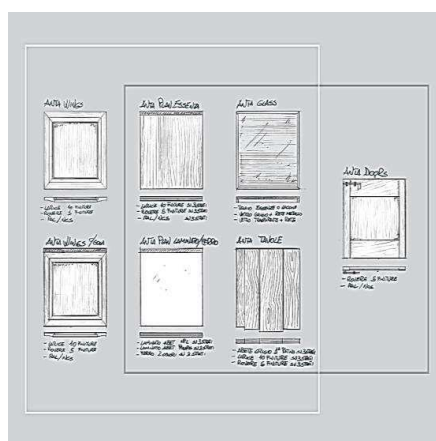

PARTNER PER LA TECNOLOGIA

Con l'obiettivo di offrire risposte e competenze innovative, per soddisfare al meglio le esigenze di ogni cliente, Tabula utilizza i migliori marchi di ferramenta presenti sul mercato. Abbiamo scelto Blum per i sistemi di apertura rallentati delle nostre cucine, Camar per il fissaggio a parete e per la regolazione a terra, Gollinucci per interni dei cassetti e le pattumiere per raccolta differenziata.



PARTNERS IN TECHNOLOGY

Tabula want to give answers and innovative skills to satisfy customer needs to the best. For this purpose, Tabula makes use of the best brands of hardware. We chose Blum for soft-close system of our kitchens, Camar for wall fastening system and ground regulation, and Gollinucci for the inner accessories of drawers.



PARTNER PER FINITURE E SUPERFICI

La ricerca e la salvaguardia dell'ambiente per un autentico sviluppo sostenibile, sono punti cardine della nostra filosofia. Abbiamo individuato e scelto partner d'avanguardia che rappresentano l'eccellenza nei loro campi, grazie alla continua ricerca nei materiali e nelle finiture.



PARTNER FOR FINISHING AND SURFACES

Key points of our philosophy are research and preservation of the environment for an authentic eco-friendly development. We have identified and chosen innovative partners which represent the excellence in their fields thanks to the constant research of materials and finishes.

I PRODOTTI • PRODUCTS

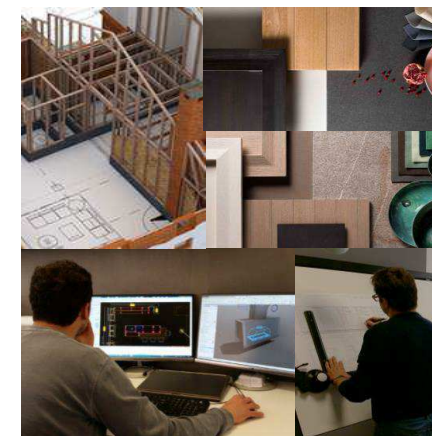

ANALISI PERSONALIZZATA DEL PROGETTO

La scrupolosa attenzione verso le esigenze di ogni singolo cliente e la nostra preparazione consentono di analizzare ogni progetto con estrema professionalità e versatilità. Pur volendo seguire le nostre scelte progettuali, "Speciale" e "Su misura" sono concetti che non ci spaventano, anzi, stimolano le nostre attività. Reinterpretiamo le vostre idee mantenendo intatta l'originalità del progetto da voi concepito.

CUSTOM ANALYSIS OF THE PROJECT

The scrupulous attention to the needs of each individual customer and our preparation allow us to analyze each project with utmost professionalism and versatility. Although we wish to follow our design projects, concepts like "special" and "fitted" don't scare us. On the contrary, they stimulate our activities. We reinterpret your ideas while maintaining the originality of the project conceived by you.

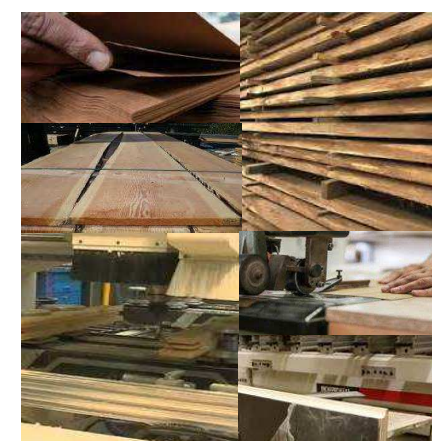

SELEZIONE DEI MATERIALI E COSTRUZIONE

Tabula pone grande attenzione nel selezionare i migliori materiali per realizzare le proprie proposte. La qualità delle materie prime utilizzate, e la loro rigida selezione, determina l'alto grado estetico che contraddistingue le collezioni. Grazie all'esperienza trentennale nella scelta dei materiali costruttivi possiamo assicurare un prodotto in grado di offrire un'assoluta stabilità.

SELECTION OF MATERIALS AND CONSTRUCTION

Tabula pays particular attention to the selection of the best materials to realize their own proposals. The quality of the raw materials used, and their strict selection, determines the high aesthetic degree that distinguishes the collections. Thanks to the thirty years of experience in the choice of materials, we can ensure a product able to provide an absolute stability.



PREMONTAGGIO E COLLAUDO

Passaggio essenziale per assicurare l'elevata qualità del prodotto, è il momento in cui il progetto prende forma. Tecnici esperti allestiscono gli arredi come se fossero all'interno dell'ambiente a cui sono destinate le realizzazioni, perfettamente adattate nella forma e nelle dimensioni. Zoccoli, fasce di tamponamento e meccanismi, vengono montati e collaudati al grezzo. Solo successivamente, tutti i componenti vengono inviati alla fase di finitura. In questo modo possiamo garantire che quanto costruito rispetti il progetto originale.

PRE ASSEMBLY AND TESTING

The moment during which the project takes shape represents an essential step to ensure the high quality of the product. Technical experts mount furnishings as if they were within the environment to which realizations are addressed, perfectly adapted in form and dimensions. Plinths, filler strips and mechanisms are untreated installed and assembled. Thereafter all the components are sent to the finishing stage. In this way we can guarantee that what was built respect the original project.



LA FINITURA DEI COMPONENTI

La concomitanza tra la professionalità e l'esperienza di chi lavora nel reparto e l'utilizzo di tinte e smalti di prima qualità, garantisce che ogni ciclo di lucidatura applicata dia un ottimo risultato. Tutti i prodotti utilizzati per la verniciatura assicurano le massime proprietà tecnologiche e un'elevata resistenza all'ingiallimento dovuto all'esposizione luminosa. Grazie alle loro proprietà antibatteriche, costituiscono una barriera contro gli agenti esterni.

FINISHING COMPONENTS

The conjunction between the professionalism and experience of those who work in the department, and the use of top-quality dyes and varnishes, ensures the excellent result of each applied polishing cycle. All products used for painting guarantee the maximum technological properties and high resistance to the yellowing due to exposure. Thanks to their anti-bacterial properties, they constitute a barrier against external agents.

CARATTERISTICHE TECNICHE • TECHNICAL FEATURES

Caratteristiche tecniche /Technical features

- Tutti i modelli presenti a listino montano guide Blumotion e cerniere con chiusura ammortizzata di serie /All elements in the pricelist are equipped with Blumotion runners and soft-closere hinges included in the price
- I meccanismi utilizzati per l'apertura e la chiusura dei pensili ribalta sono Blum /The mechanisms used for opening and closing the hanging flap are Blum
- La struttura di tutti i moduli è in listellare di legno spessore 18 mm /The structure is in all forms of wood strips thickness 18 mm
- La schiena dei moduli è in compensato di legno spessore 8 mm /The module back is in plywood thickness 8 mm
- I ripiani sono in listellare di legno spessore 18 mm e sono dotati di bordo rialzato antiscivolo /The shelves are in blockboard of 18 mm thick wood and are equipped with non-slip raised edge
- I cesti estraibili e gli scolapiatti sono in finitura titanio /The pull-out baskets and drainer are titanium finish
- Gli zoccoli delle cucine sono tagliati a misura su ogni singola composizione /The plinth of the kitchens are cut to size of each composition
- Tutti gli elementi che compongono la cucina vengono premontati /All the elements that make up the kitchen are preassembled

Manutenzione, uso e garanzia /Maintenance, use and warranty

■ Laminato /Laminate

Pulizia: Pulire con prodotti per la pulizia dei vetri o soluzione d'acqua con ammoniacca al 10%. Asciugare subito con un panno morbido e non abrasivo. I detersivi ad azione abrasiva non sono idonei./Cleaning: Clean with products for cleaning glass or water solution with ammonia 10%. Asciugare immediatamente with a soft, non-abrasive cloth. Detergents an abrasive action are not eligible.

■ Laccato opaco /Matt lacquered

Pulizia: Pulire con un panno imbevuto di soluzione acqua e sapone neutro e asciugare con un tessuto morbido non abrasivo. I detersivi ad azione abrasiva non sono idonei./Cleaning: Use a cloth soaked in a solution of water and mild soap and dry with a soft non-abrasive tessuto. Detergents an abrasive action are not eligible.

■ Legno /Wood

Pulizia: Pulire con un panno imbevuto di soluzione acqua e sapone neutro e asciugare con un tessuto morbido non abrasivo. I detersivi ad azione abrasiva non sono idonei./Cleaning: Use a cloth soaked in a solution of water and mild soap and dry with a soft non-abrasive tessuto. Detergents an abrasive action are not eligible.

■ Finitura epossidica /Epoxy finish

Pulizia: Pulire con una spugna morbida imbevuta d'acqua e detersivi neutri e asciugare con un tessuto morbido non abrasivo. I detersivi ad azione abrasiva non sono idonei./Cleaning: Clean with a soft sponge soaked in water and neutral detergent and dry with a soft non-abrasive tessuto. Detergents an abrasive action are not eligible.

■ Resina /Resin

Pulizia: Pulire con acqua calda e un panno morbido non abrasivo. I detersivi ad azione abrasiva non sono idonei./Cleaning: Clean with warm water and a soft non-abrasive cloth. Detergents an abrasive action are not eligible.

■ Marmi naturali e graniti /Natural marble and granite

Tutte le pietre naturali, in quanto tali, sono caratterizzate da irregolarità, venature più o meno marcate, presenza fossili o intrusioni di vario genere. Queste caratteristiche rendono unico ogni prodotto realizzato aumentandone il pregio e il valore nel tempo. E' importante nella scelta di un materiale naturale tenere nella dovuta considerazione questi punti e apprezzarne ogni sfumatura. Eventuali piccoli interventi di stuccatura sono da considerarsi del tutto normali e necessarie per l'esecuzione di un lavoro a regola d'arte. E' importante ricordare che durante la composizione di un Top cucina realizzato con spessori diversi, o nell'accostamento tra piano e schienale, non necessariamente potranno essere utilizzate le stesse lastre. /All natural stones, as such, are characterized by irregularities, more or less marked grain, presence fossil or intrusions of various kinds. These features make every single product made by increasing the value and the value over time. It ' important in the choice of a natural material give due consideration to these points and to appreciate every nuance. Any small interventions of grouting are to be considered quite normal and necessary for the execution of a state of the art work. It ' important to remember that when composing a Top cuisine made with different thicknesses, or in the approach between the top and back, not necessarily can be used the same plates.

Pulizia: Si consiglia di rimuovere tempestivamente qualsiasi residuo di sostanza che si versa sul Top. Pulire con panno in microfibra edetergente neutro. Il trattamento superficiale con gli anni tende a scomparire per evaporazione. Se ne consiglia il ripristino in base all'utilizzo almeno una volta all'anno. /Cleaning: It is recommended to promptly remove any remaining substance that is poured on top. Pulire neutral edetergente with microfibre cloth. The surface treatment with the years tends to disappear by evaporation. It recommends restoring based on usage at least once a year.

NOTE PER PROGETTAZIONE • NOTES FOR DESIGN

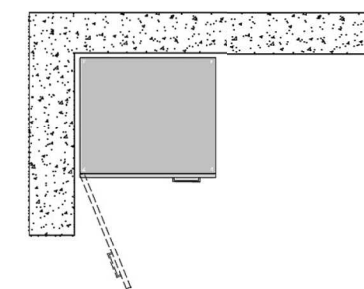

Soluzioni per il montaggio delle colonne a lato di una parete / Solutions for fitting tall units by the wall

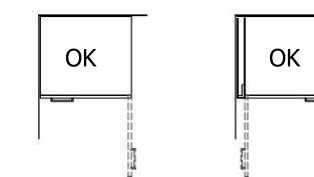

Soluzioni per il montaggio delle basi a lato di una parete / Solutions for fitting base units by the wall

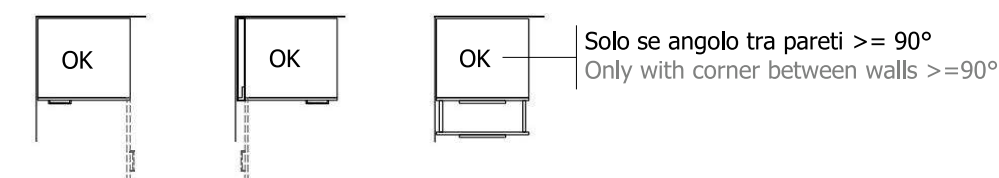

Soluzioni per il montaggio pensile a lato di una parete / Solutions for fitting wall units by the wall

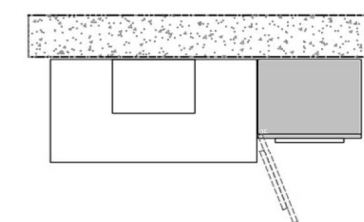

Soluzioni per il montaggio pensile a lato della cappa / Solutions for fitting wall units by the hood

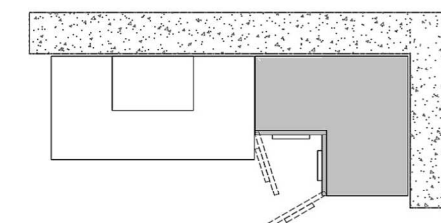
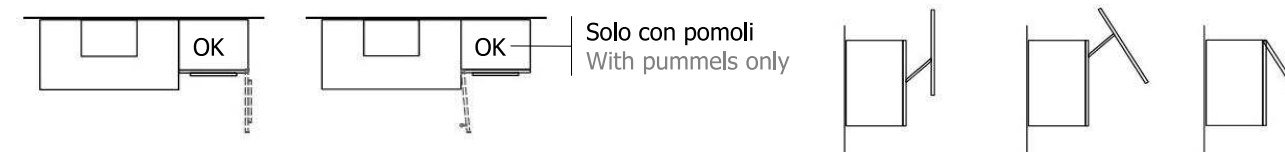

Soluzione per il montaggio pensile angolo a lato della cappa / Solution for fitting corner wall units by the hood

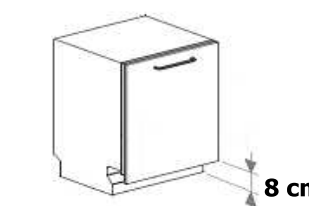
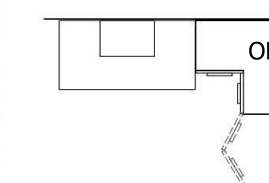

Sceita elettrodomestici con appoggio a terra / Choice of domestic appliances with support on the ground

Per garantire la corretta funzionalità di lavastoviglie, frigo o altre apparecchiature appoggiate a terra, si devono scegliere solo articoli compatibili con lo zoccolo altezza 8 cm. In caso contrario si deve tassativamente specificarlo al momento dell'ordine, in modo da poter modificare l'altezza dello zoccolo su tutta la cucina / To ensure the function of the dishwasher, the refrigerator or other equipment on the ground you have to choose items consistent with the plinth height 8 cm only. Otherwise, you have to specify when ordering. In this way we can modify the height of the plinth of the whole kitchen.

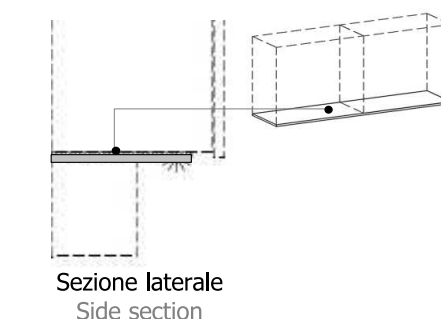



Pannello di finitura sotto pensile / Finishing panel under wall unit

Pannello di finitura sotto pensile che permette di rifinire la parte inferiore dei pensili con un elemento intero che non lasci in vista la divisione dei vari moduli. Su di esso si possono premontare i dispositivi luminosi senza problemi di cablaggio o cavi a vista. Il suo impiego è indispensabile in caso si vogliano disporre elementi "SOTTO PENSILE" e "SOPRA PIANO" / Finishing panel, under-wall unit cover panel, under-wall unit that allows ti finish the bottom of the wall units with an entire element that does not leave the division in view of the cvarious element. Su it can be pre-assemble the luminous devices without wiring problems or cables vista.Il its use is essential in case you want to have lements "SOTTO PENSILE" and "SOPRA PIANO"

Sezione laterale
Side section

CAMPIONARI MATERIALI E FINITURE • SAMPLE MATERIALS AND FINISHES

Elemento Unit	Descrizione Description	Dimensioni Dimension	Codice Code	Prezzo Price
	<ul style="list-style-type: none"> • ANTA A CAMPIONE RAL/NCS Prezzo per l'esecuzione di un'anta a campione con riferimento dato dalla tabella RAL o NCS • RANDOMLY DOOR RAL/NCS Price for the execution randomly door reference given in the table RAL OR NCS 	Dimensioni/Dimensions 45 x 45 cm		170
		Dimensioni/Dimensions 81 x 60 cm		215
	<ul style="list-style-type: none"> • ANTA CAMPIONARIO Anta campionario aggiuntiva alla dotazione di serie • SAMPLE DOOR Additional door samples to the standard equipment 			
	Anta campionario singola/Single sample Door	Dimensioni/Dimensions 45 x 45 cm		130
	Set 4 Ante campionario/Set 4 sample Door	Dimensioni/Dimensions 45 x 45 cm		320
	<ul style="list-style-type: none"> • BOX MATERIE Box comprensivo di campioncini colore finiture legno,metalli,Abete 1° Patina,interni e Print di serie,Pietre e Resine • SAMPLES BOX Box including samples wood color finishes, metals, Spruce 1° Patina, Interior and print of series finishes,stones and resins 			
	Box Materia 1: Legno /Box Matter 1 Wood	Dimensioni/Dimensions 47 x 13,5 x H.23 cm		420
	Box Materia 2: Pietre /Box Matter 2 Stones	Dimensioni/Dimensions 23,5 x 13,5 X H.23 cm		200
	Box Materia 3: Resine /Box Matter 3 Resins	Dimensioni/Dimensions 23,5 x 13,5 X H.23 cm		240

TIPOLOGIE FRONTALI CUCINA KITCHEN FRONT TYPE

WINGS

DESIGN DESIGN

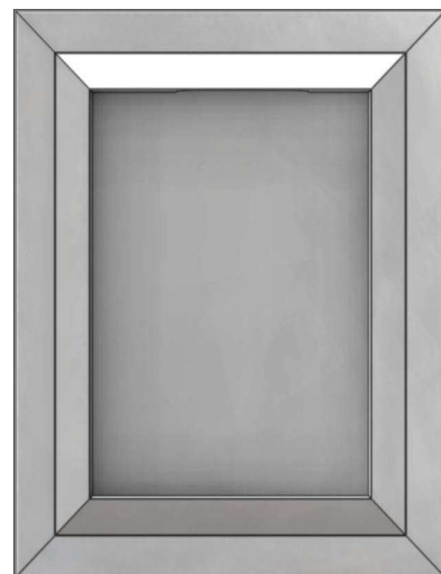

MATERIA MATTER



NOTE SPECIFICHE PER LA PROGETTAZIONE SPECIFIC NOTES FOR THE DESIGN

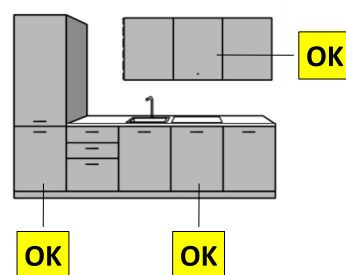

I frontali cucina della serie WINGS sono estremamente versatili. Si possono usare indistintamente su basi, colonne e pensili cucina. Le ante possono avere la parte centrale in vetro. WINGS fronts can equip with bases, tall units and wall units indiscriminately. The central part can consist of glass.

FASCIA PREZZO PRICE RANGE

7

7



FRONTALI CUCINA CON TELAIO IN LEGNO MASSELLO - Spessore 30 mm KITCHEN FRONTS WITH SOLID WOOD FRAME - 30 mm thickness

MODULARITA' FRONTALI CON MANIGLIE MODULARITY FRONTS WITH HANDLES

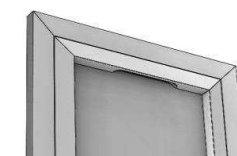

Mod. INCASSO

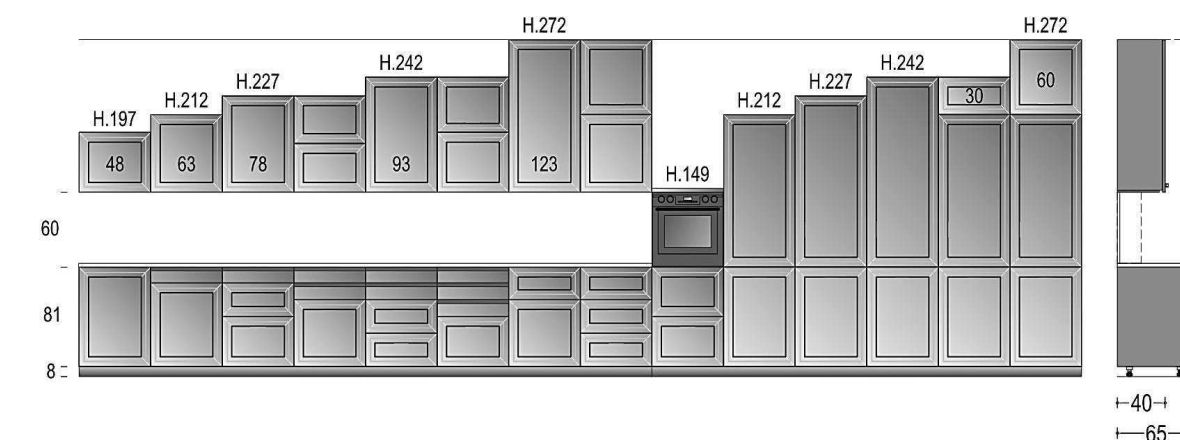
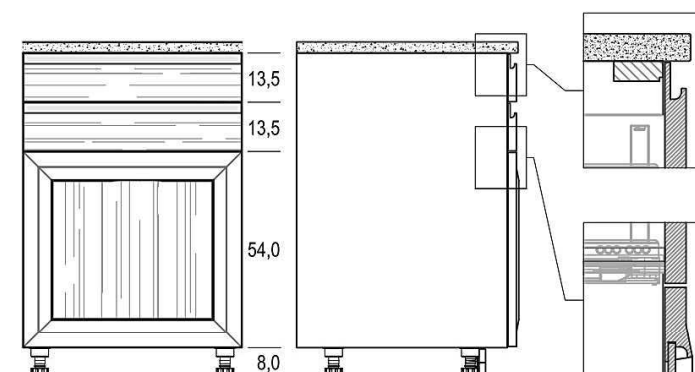

MODULARITA' FRONTALI PER BASI CON GOLA MODULARITY FRONTS BASES WITH GRIP GROOVE

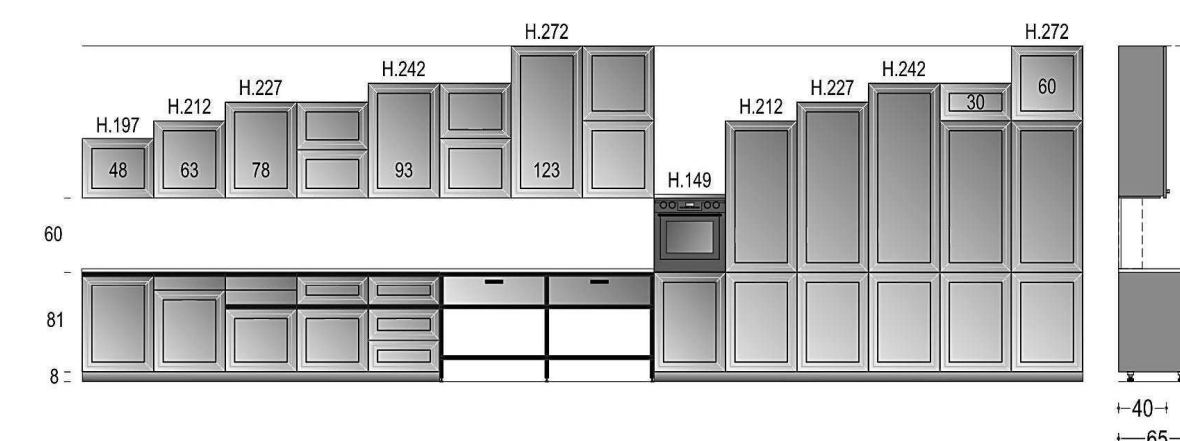
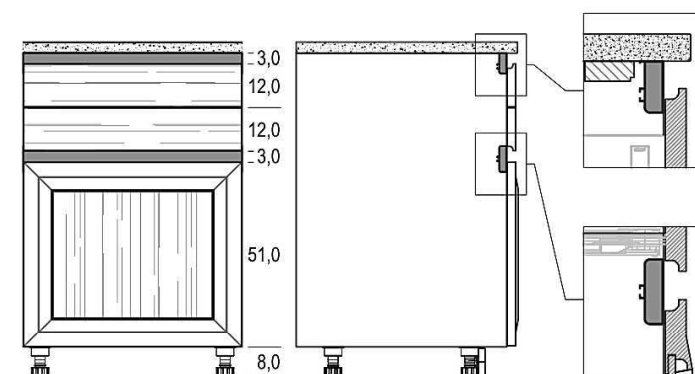

DOORS

DESIGN DESIGN

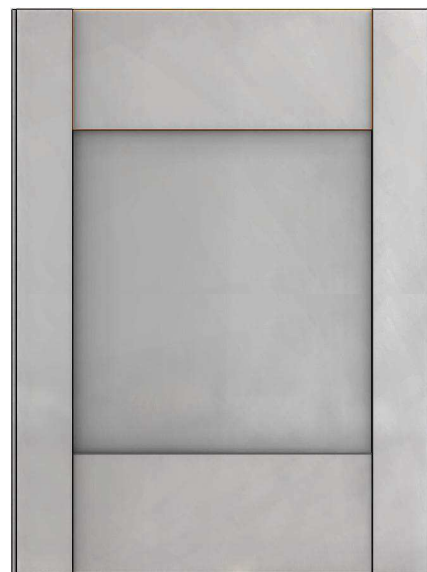

MATERIA MATTER

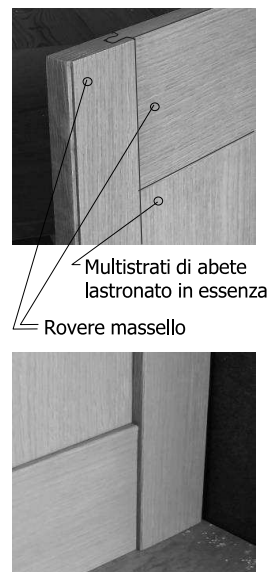

NOTE SPECIFICHE PER LA PROGETTAZIONE SPECIFIC NOTES FOR THE DESIGN

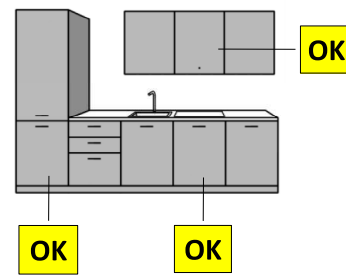

Per le loro caratteristiche geometriche i frontali della serie DOORS sono particolarmente indicati per essere usati su basi cucina. Si possono comunque usare anche su colonne e pensili. Due tue their geometrical characteristics, DOORS fronts are particularly indicated to be used on kitchen bases. They can be also used on columns and fronts anyway.

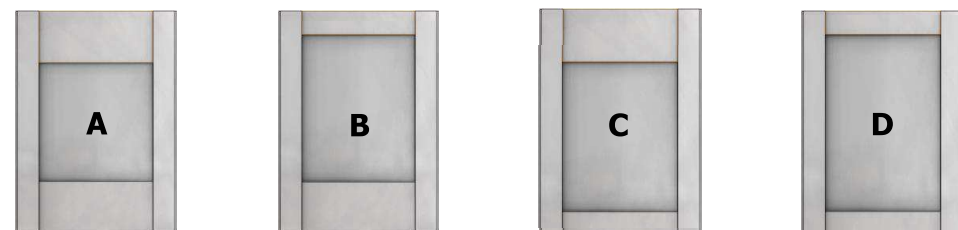

FASCIA PREZZO PRICE RANGE

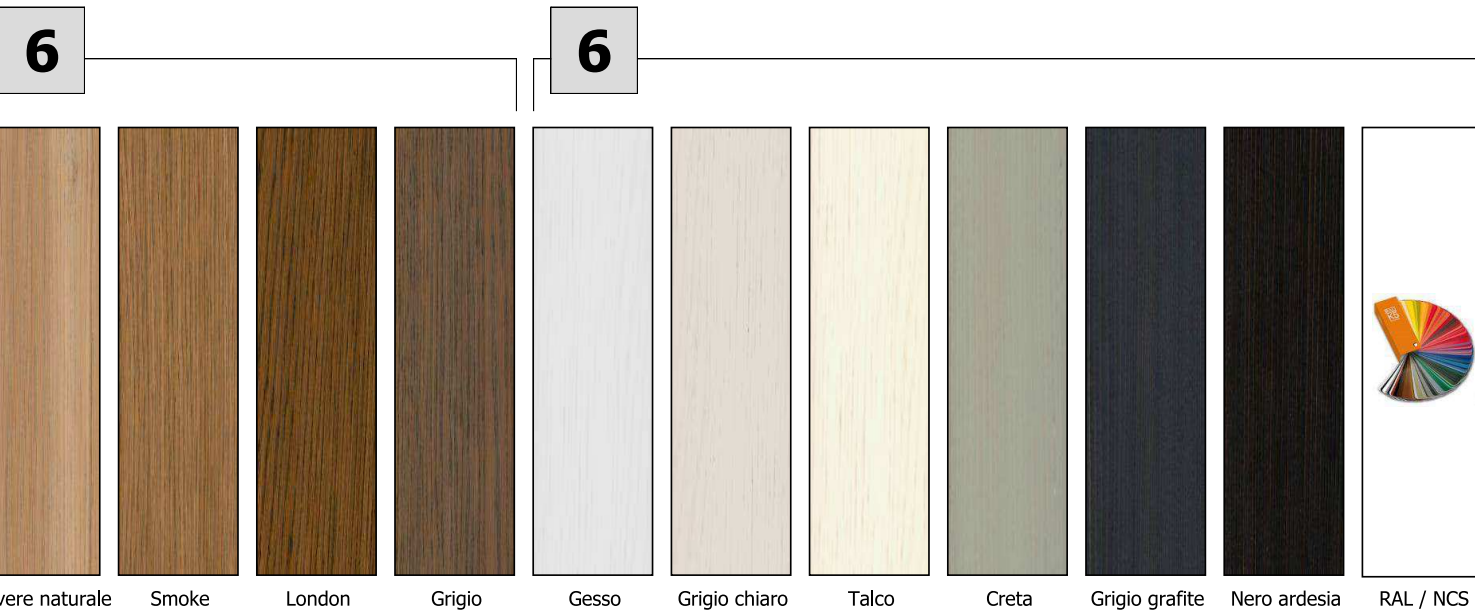

Rovere naturale Smoke London Grigio Gesso Grigio chiaro Talco Creta Grigio grafite Nero ardesia RAL / NCS

VETRO GLASS

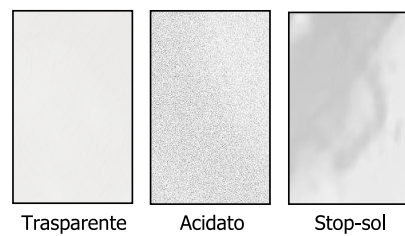

Trasparente Acidato Stop-sol

FRONTALI CUCINA CON TELAIO IN LEGNO MASSELLO - Spessore 23 KITCHEN FRONTS WITH SOLID WOOD FRAME - 23 thickness

MODULARITA' FRONTALI CON MANIGLIE MODULARITY FRONTS WITH HANDLES

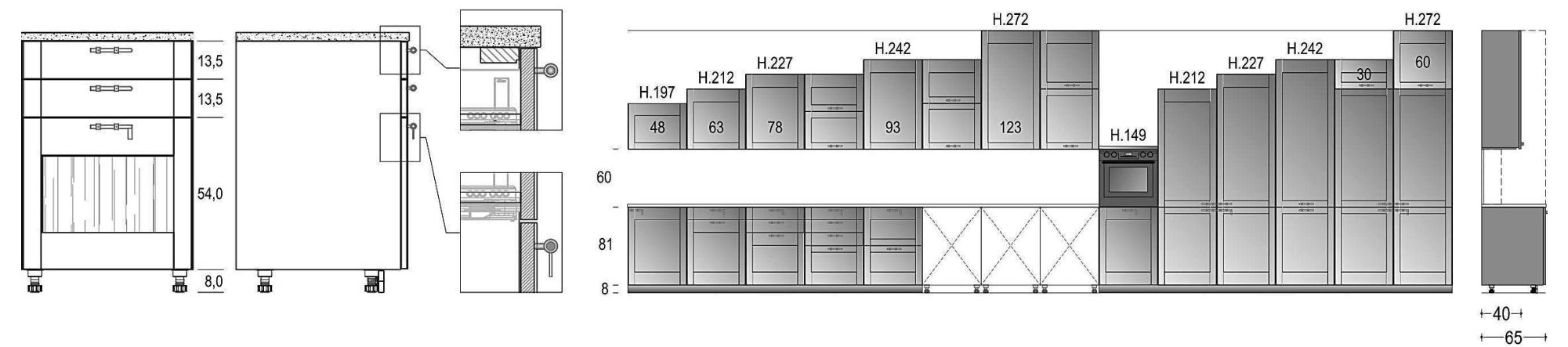

TAVOLA

DESIGN DESIGN

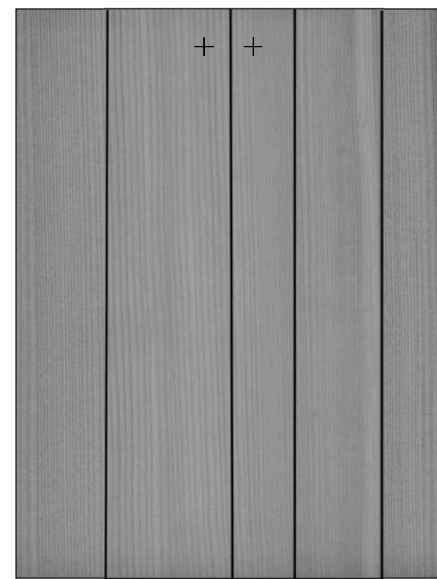

MATERIA MATTER

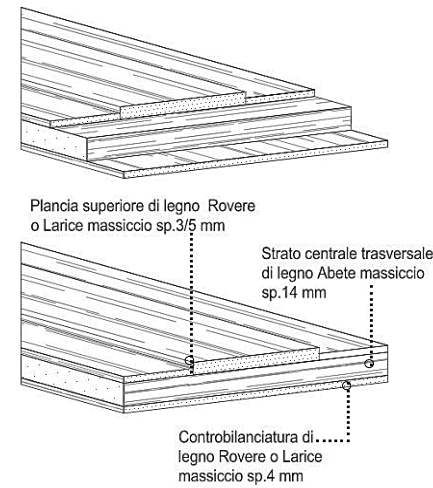

NOTE SPECIFICHE PER LA PROGETTAZIONE SPECIFIC NOTES FOR THE DESIGN

STANDARD TYPE

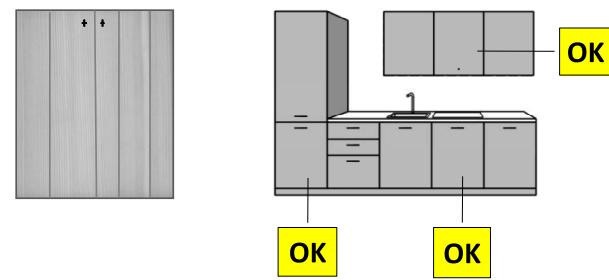

I frontali cucina della serie TAVOLA/Standard, si possono utilizzare su basi, colonne e pensili cucina.
TAVOLA/Standard fronts can equip with bases, tall units and wall units indiscriminately.

RANDOM TYPE

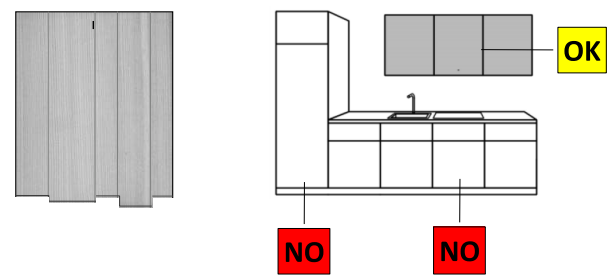

I frontali cucina della serie TAVOLA/RANDOM, sono destinati a corredare solo pensili per la cucina.
TAVOLA/RANDOM fronts can equip only wall units for kitchen.

FASCIA PREZZO PRICE RANGE

5

5



FRONTALI CUCINA IN LEGNO TRE STRATI - Spessore 23 KITCHEN FRONTS IN THREE BOARDS WOOD - 23 tickness

MODULARITA' FRONTALI CON MANIGLIE MODULARITY FRONTS WITH HANDLES

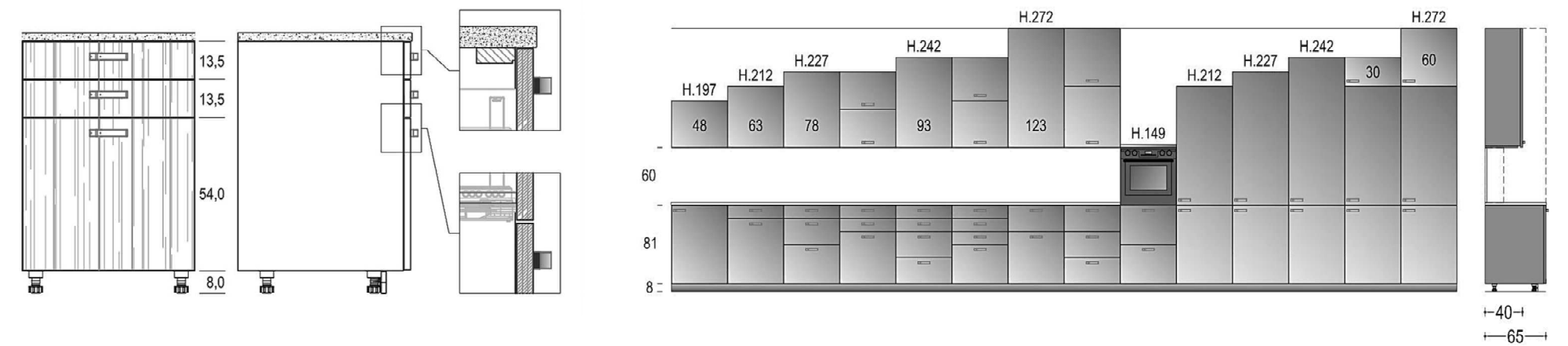

MODULARITA' FRONTALI PER BASI CON GOLA MODULARITY FRONTS BASES WITH GRIP GROOVE



TAVOLA 1°PATINA

DESIGN DESIGN



MATERIA MATTER

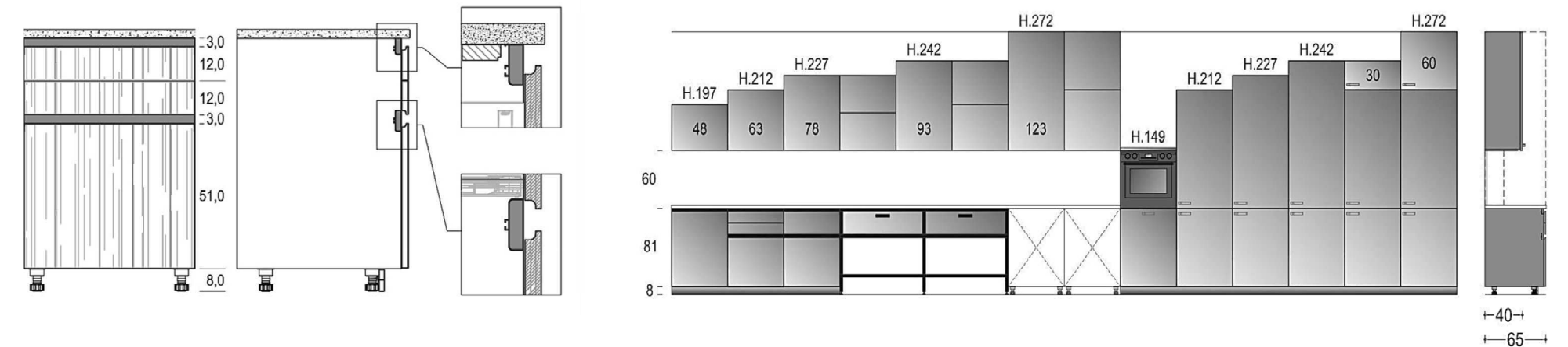
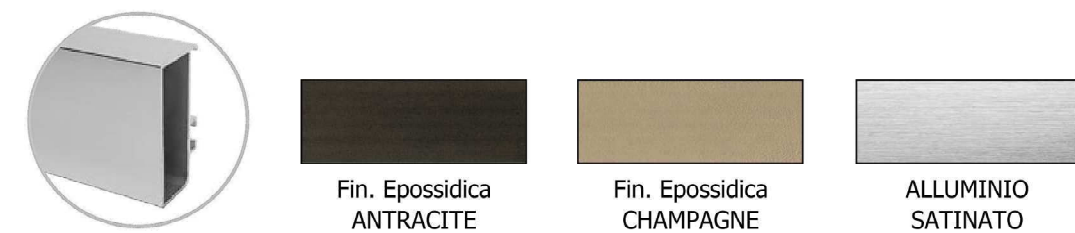

NOTE SPECIFICHE PER LA PROGETTAZIONE SPECIFIC NOTES FOR THE DESIGN

STANDARD TYPE

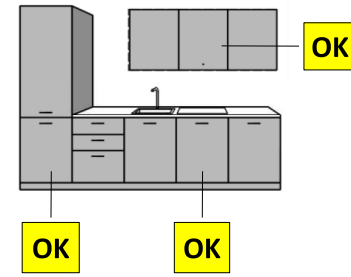

I frontali cucina della serie TAVOLA 1°PATINA/Standard, si possono utilizzare su basi, colonne e pensili cucina. TAVOLA 1°PATINA/Standard fronts can equip with bases, tall units and wall units indiscriminately.

RANDOM TYPE

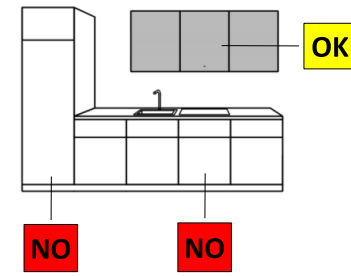

I frontali cucina della serie TAVOLA 1°PATINA/Random sono destinati a corredare solo pensili per la cucina. TAVOLA 1°PATINA/Random fronts can equip only wall units for kitchen.

FASCIA PREZZO PRICE RANGE

5

ABETE 1°PATINA FIR OLD WOOD



Colore naturale risultante dal processo di ossidazione degli agenti atmosferici+Protettivo all'acqua/Natural color oxidized weathering+Protective water

FRONTALI CUCINA IN ABETE TRE STRATI - Spessore 23 KITCHEN FRONTS IN THREE BOARDS FIR - 23 tickness

MODULARITA' FRONTALI CON MANIGLIE MODULARITY FRONTS WITH HANDLES



Mod. LEVA



Mod. CATENACCIO



Mod. CATENACCIO-Dx



Mod. 1071



Mod. 319

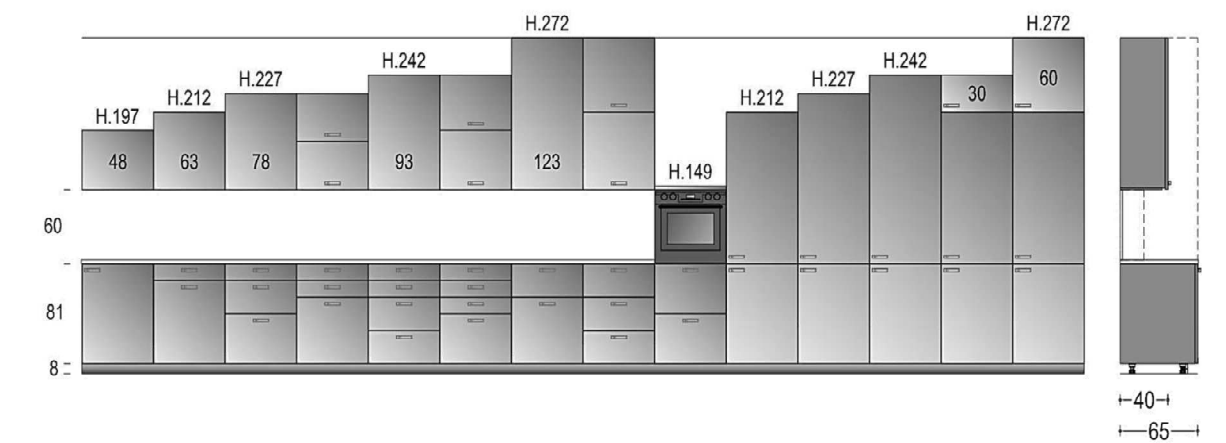
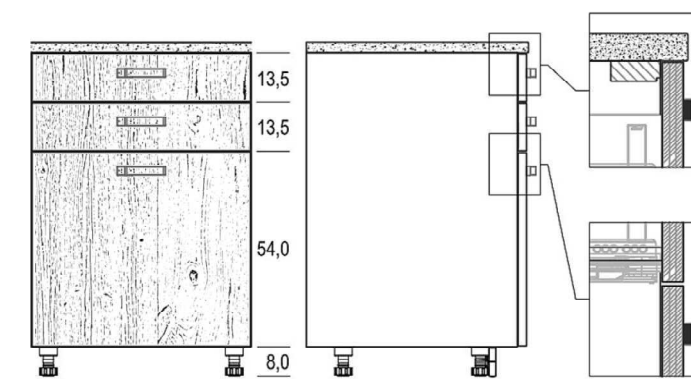

MODULARITA' FRONTALI PER BASI CON GOLA MODULARITY FRONTS BASES WITH GRIP GROOVE

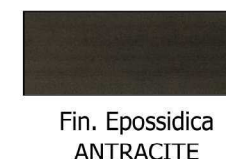

Fin. Epossidica ANTRACITE



Fin. Epossidica CHAMPAGNE



ALLUMINIO SATINATO

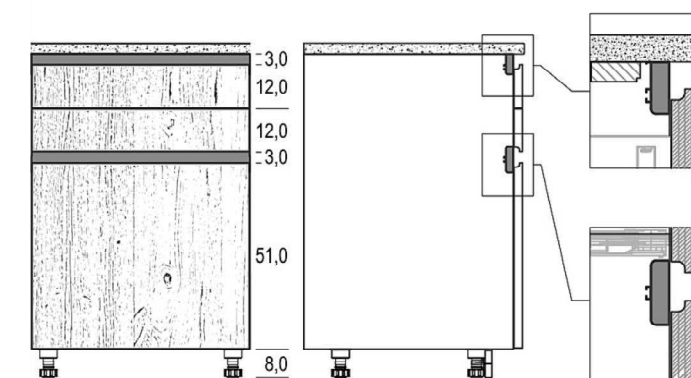

PLAN

DESIGN DESIGN

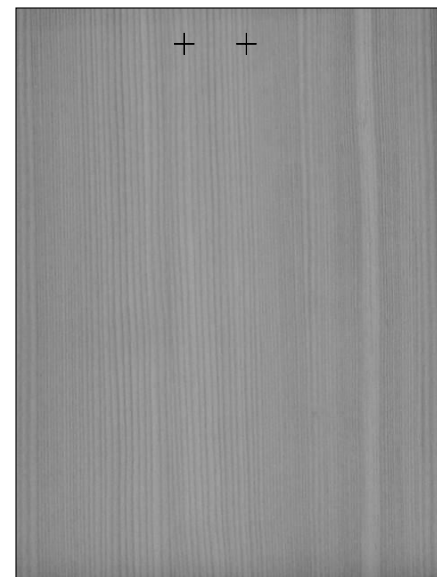

MATERIA MATTER

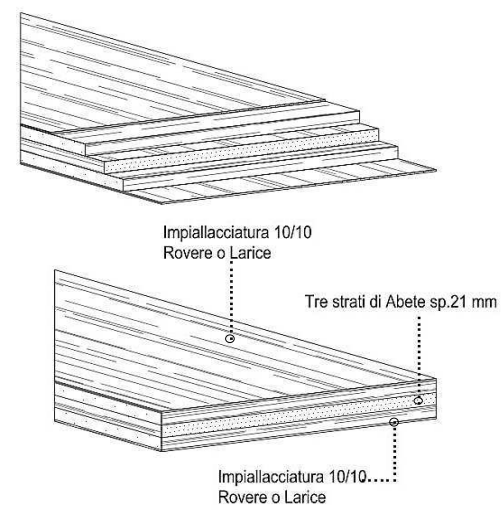

NOTE SPECIFICHE PER LA PROGETTAZIONE SPECIFIC NOTES FOR THE DESIGN

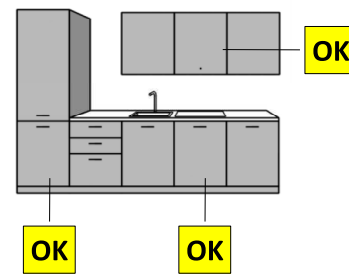

I frontali cucina della serie PLAN sono estremamente versatili. Possono corredate indistintamente basi, colonne e pensili cucina. PLAN fronts kitchen are truly versatile. They can equip bases, columns and fronts kitchen indistinctly.

FASCIA PREZZO PRICE RANGE

2

2



FRONTALI CUCINA IMPIALLACCIATI SU PANNELLO LEGNO TRE STRATI - Spessore 23 KITCHEN FRONTS VENEERED ON THREE BOARDS WOOD PANEL - 23 tickness

MODULARITA' FRONTALI CON MANIGLIE MODULARITY FRONTS WITH HANDLES

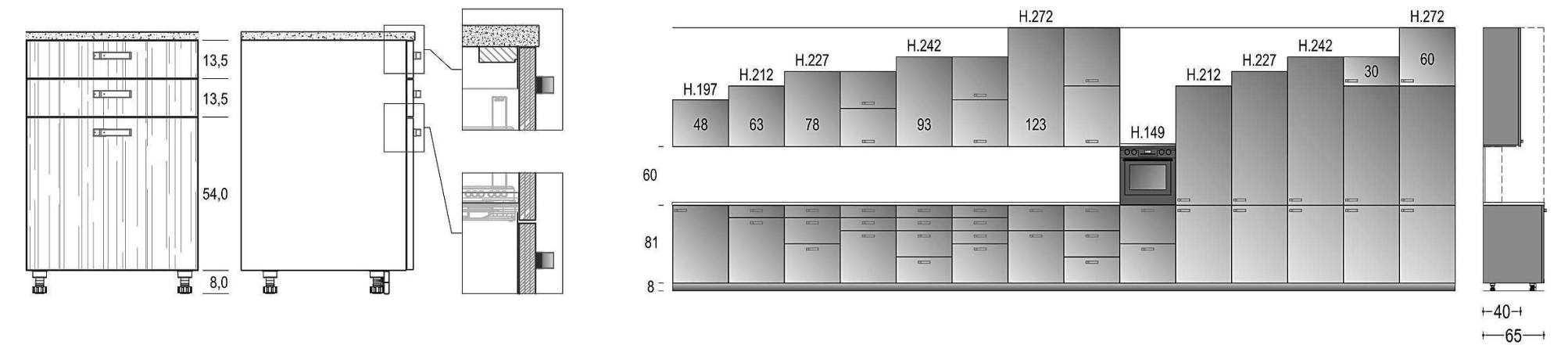

MODULARITA' FRONTALI PER BASI CON GOLA MODULARITY FRONTS BASES WITH GRIP GROOVE

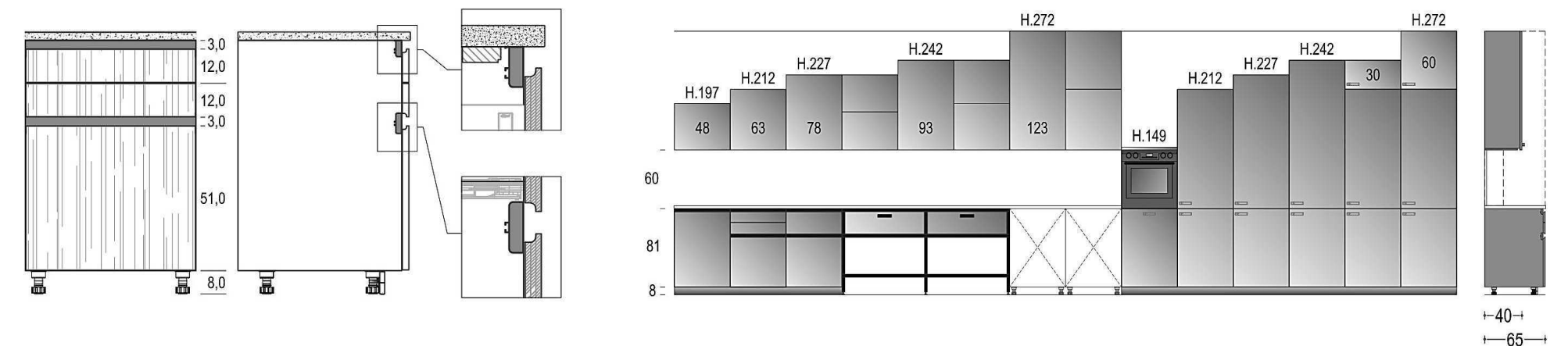
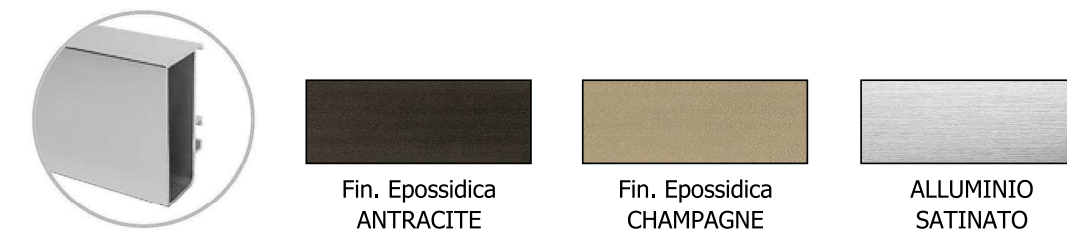

PRINT

DESIGN DESIGN

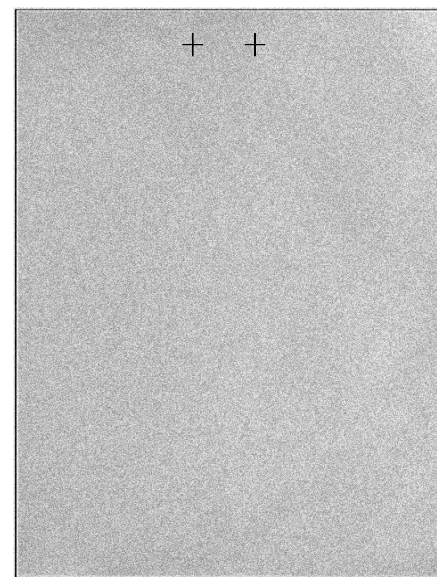

MATERIA MATTER

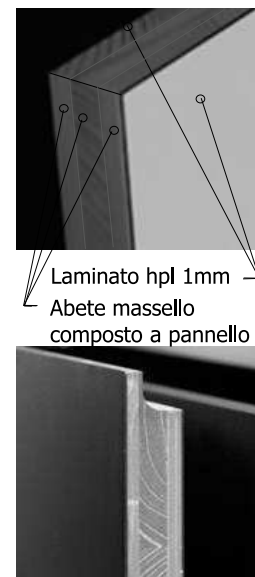

NOTE SPECIFICHE PER LA PROGETTAZIONE SPECIFIC NOTES FOR THE DESIGN

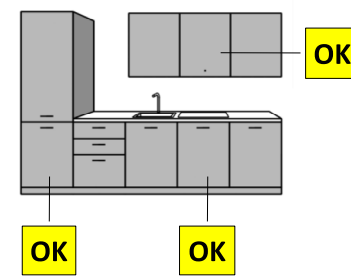

I frontali cucina della serie PRINT sono estremamente versatili. Possono corredare indistintamente basi, colonne e pensili cucina. PRINT fronts kitchen are truly versatile. They can equip bases, columns and fronts kitchen indistinctly.

FRONTALI CUCINA IN LAMINATO HPL SU PANNELLO LEGNO TRE STRATI - Spessore 23 HPL KITCHEN FRONTS ON THREE BOARDS WOOD PANEL - 23 tickness

MODULARITA' FRONTALI CON MANIGLIE MODULARITY FRONTS WITH HANDLES

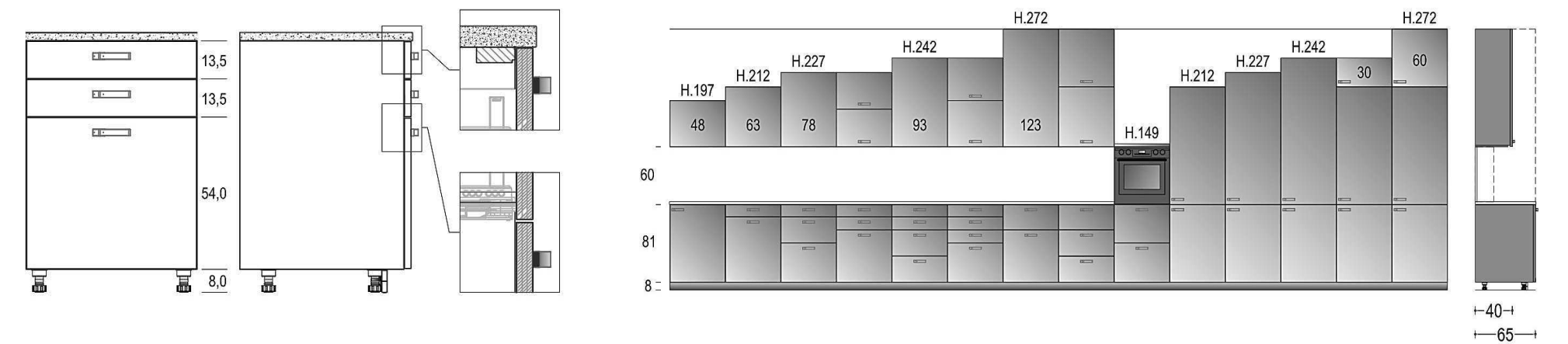

FASCIA PREZZO PRICE RANGE

1



3

LAMINATO POLARIS Fin.Polaris LAMINATE POLARIS Fin.Polaris



MODULARITA' FRONTALI PER BASI CON GOLA MODULARITY FRONTS BASES WITH GRIP GROOVE

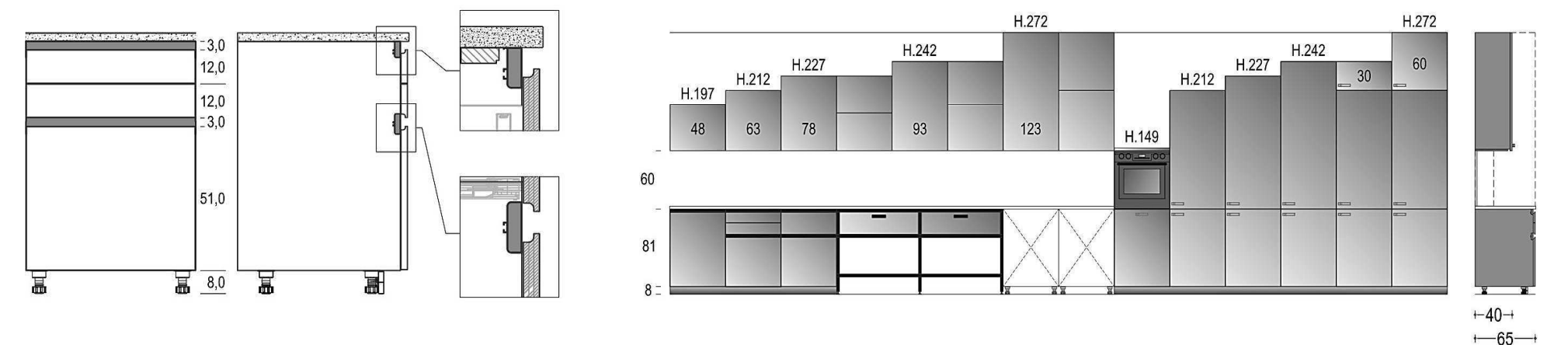
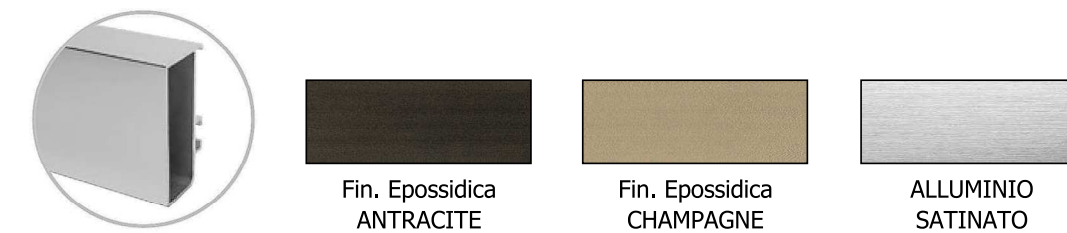

METAL

DESIGN DESIGN



MATERIA MATTER

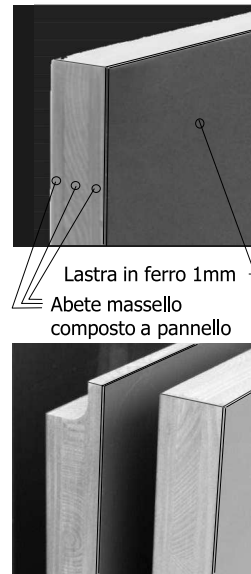

NOTE SPECIFICHE PER LA PROGETTAZIONE SPECIFIC NOTES FOR THE DESIGN

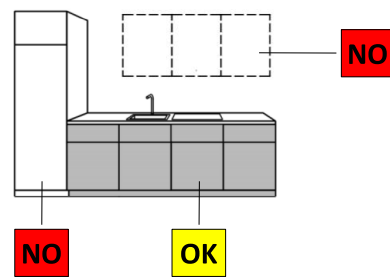

Per le loro particolari caratteristiche i frontali cucina della serie METAL possono corredare solo basi cucina.
Due to their special features the front of the kitchen METAL series may be attached only kitchen basics.

FASCIA PREZZO PRICE RANGE

3

LA STRA METALLICA
Fin. Epossidica
SLAB METAL
Epoxy finishing

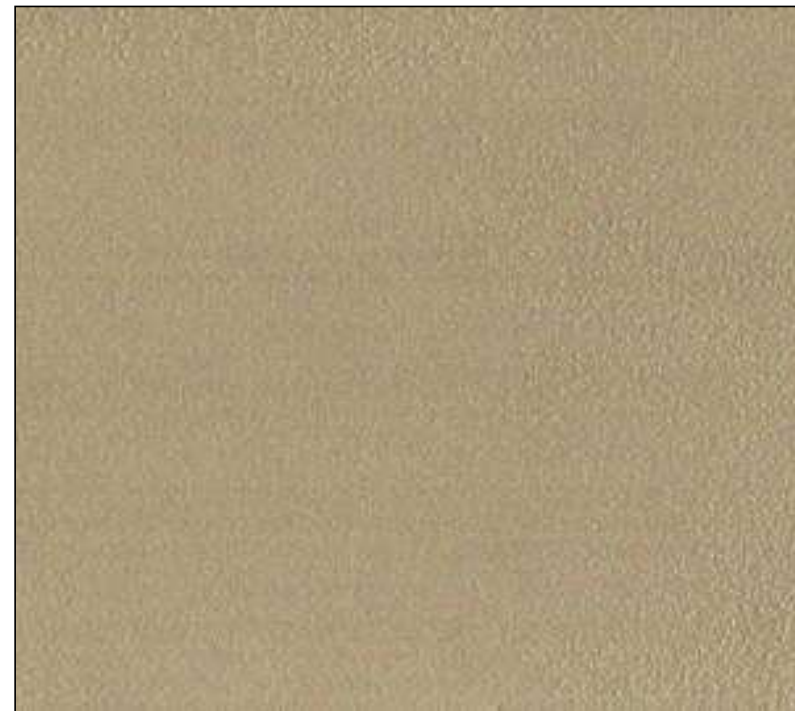

Colore Champagne



Colore Antracite

FRONTALI CUCINA CON LASTRA IN FERRO SU PANNELLO LEGNO TRE STRATI - Spessore 23 KITCHEN FRONTS WITH IRON SHEET ON THREE BOARDS WOOD PANEL - thickness 23

MODULARITA' FRONTALI CON MANIGLIE MODULARITY FRONTS WITH HANDLES

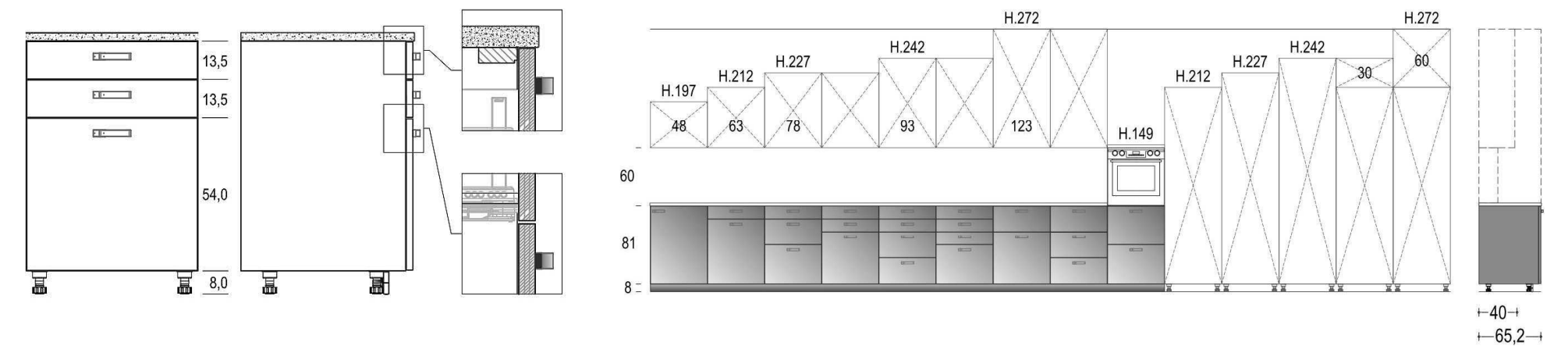

MODULARITA' FRONTALI PER BASI CON GOLA MODULARITY FRONTS BASES WITH GRIP GROOVE

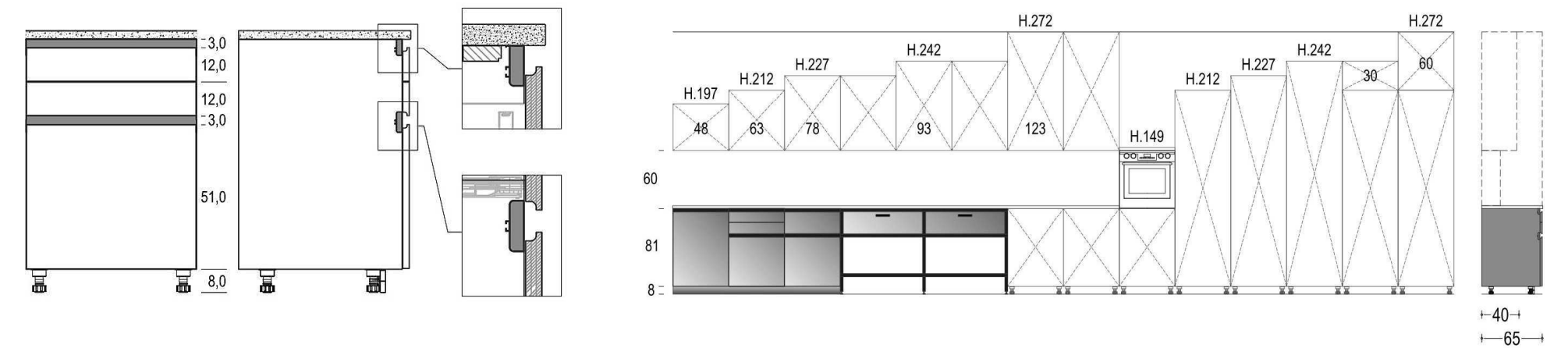
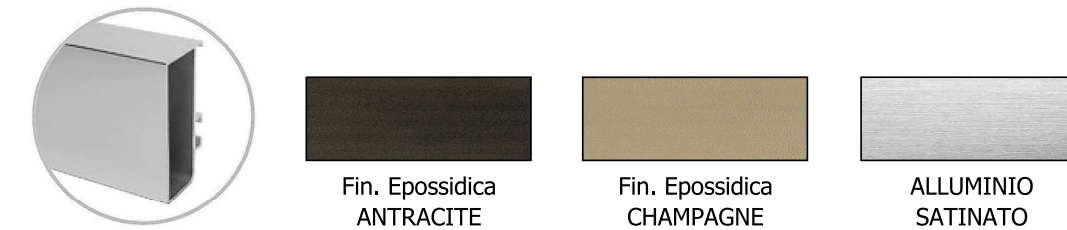

GLASS

DESIGN DESIGN

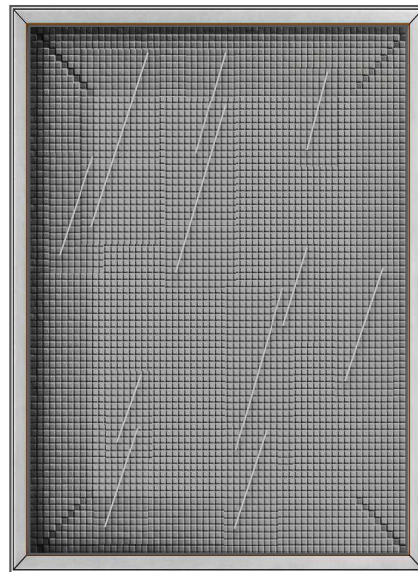

MATERIA MATTER

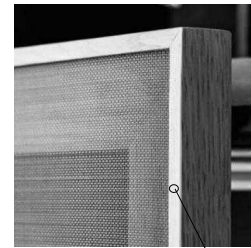

Rovere massello
(telaio assemblato a giunti)



NOTE SPECIFICHE PER LA PROGETTAZIONE SPECIFIC NOTES FOR THE DESIGN

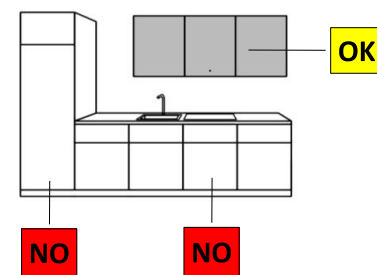

I frontali della serie GLASS, per struttura e caratteristiche costruttive possono corredare solo pensili di altezza 48, 63 o 78cm.
Due to their special features the GLASS fronts may equip only wall units with an height of 48, 63 or 78cm.

FRONTALI CUCINA CON TELAIO IN LEGNO MASSELLO - Spessore 23 KITCHEN FRONTS WITH SOLID WOOD FRAME - 23 thickness

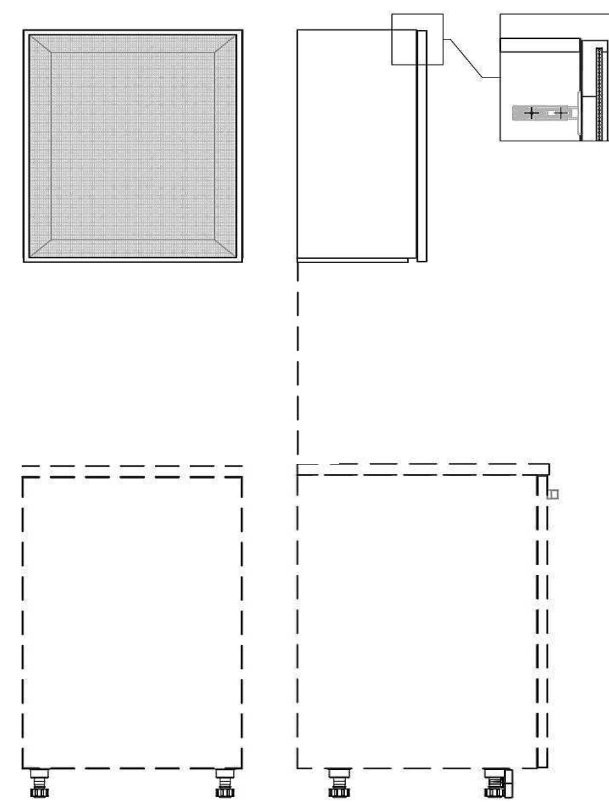

MODULARITA' FRONTALI MODULARITY FRONTS

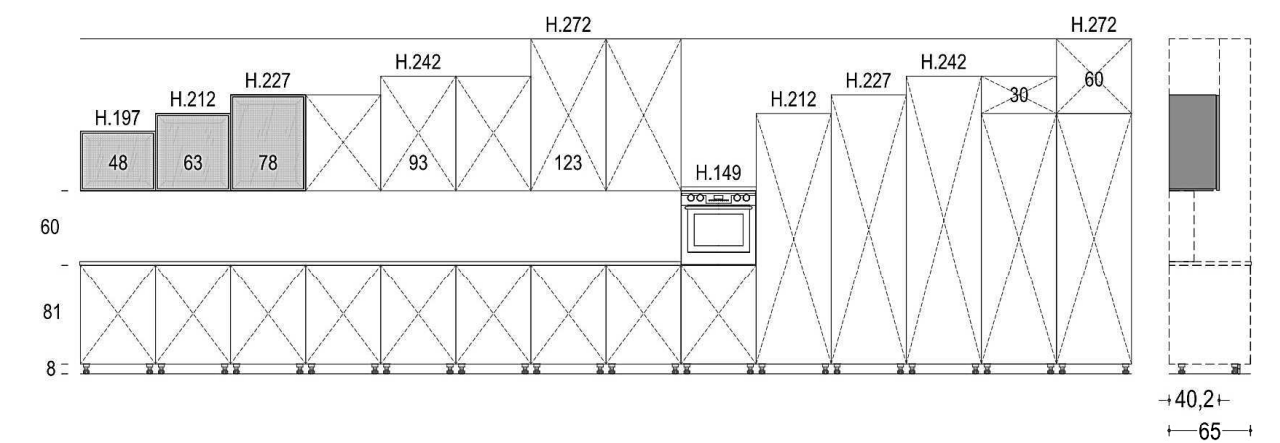

FASCIA PREZZO PRICE RANGE

8

7

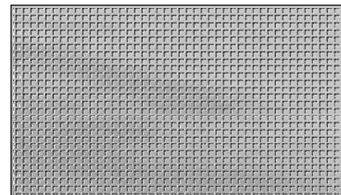

Vetro fumè grigio+maglia metallica

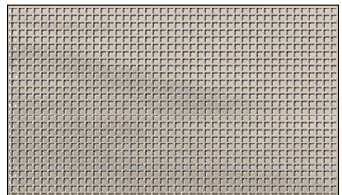

Vetro fumè bronzo+maglia metallica



Stop-sol



Acidato



Trasparente

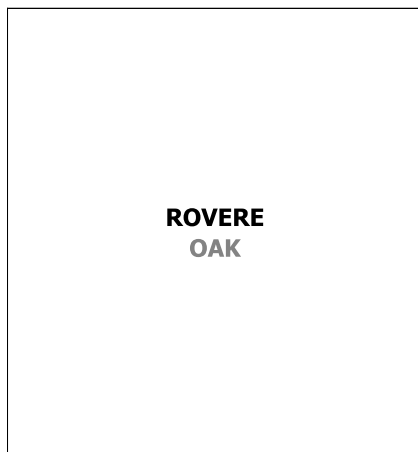

Rovere naturale



Smoke



London



Grigio

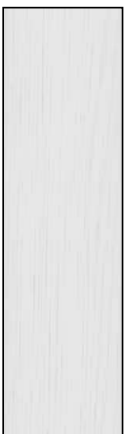

Gesso



Grigio chiaro



Talco



Creta



Grigio grafite



Nero ardesia



RAL / NCS



**BASI
BASES**

BASI BASES

Prof. Depth **65**

Altezza Height **89**

• I prezzi NON comprendono maniglie, gole, top, alzatine e zoccolo • Prices do NOT included the handles, the groove, the worktop, the upstand and the plinth

Elemento Unit	Larghezza Width	Codice Code	1	2	3	4	5	6	7	8	9
---------------	-----------------	-------------	---	---	---	---	---	---	---	---	---

• BASE 1 ANTA

Con due ripiani interni regolabili

◊ La base si può ridurre in profondità, senza maggiorazioni di prezzo fino a 35cm

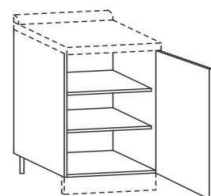

• BASE UNIT 1 DOOR

With two internal adjustable shelves

◊ The base unit can be reduced in depth, without price surcharge up to 35cm



Da/From **20 a/to 45**

B045

623	628	639	646	692	682	784	-	-			

Da/From **46 a/to 65**

B065

721	731	744	748	817	787	893	-	-			
-----	-----	-----	-----	-----	-----	-----	---	---	--	--	--

• BASE 2 ANTE

Con due ripiani interni regolabili

◊ La base si può ridurre in profondità, senza maggiorazioni di prezzo fino a 35cm

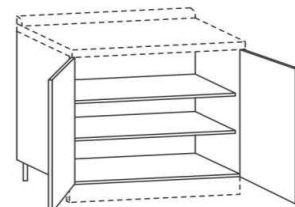

• BASE 2 UNIT DOORS

With two internal adjustable shelves

◊ The base unit can be reduced in depth, without price surcharge up to 35cm



Da/From **60 a/to 95**

B095

1.001	1.014	1.034	1.044	1.139	1.120	1.320	-	-			
-------	-------	-------	-------	-------	-------	-------	---	---	--	--	--

Da/From **96 a/to 130**

B130

1.208	1.225	1.251	1.261	1.399	1.337	1.548	-	-			
-------	-------	-------	-------	-------	-------	-------	---	---	--	--	--

• BASE 1 ANTA + CASSETTO INTERNO

Con un cassetto interno e un ripiano interno regolabile

◊ La base si può ridurre in profondità, senza maggiorazioni di prezzo fino a 35cm

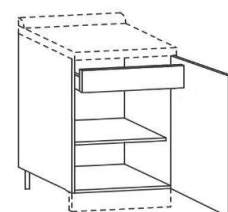

• BASE 1 DOOR + INTERNAL DRAWER

With a drawer inside and internal adjustable shelf

◊ The base unit can be reduced in depth, without price surcharge up to 35cm



blum
LEGRABOX

Da/From **30 a/to 45**

B045B1

738	744	754	758	807	797	896	-	-			
-----	-----	-----	-----	-----	-----	-----	---	---	--	--	--

Da/From **46 a/to 65**

B065B1

833	843	856	863	932	899	1.004	-	-			
-----	-----	-----	-----	-----	-----	-------	---	---	--	--	--

• BASE 1 ANTA + CASSETTI INTERNI

Con due cassetti e un cassetto interni

◊ La base si può ridurre in profondità, senza maggiorazioni di prezzo fino a 35cm

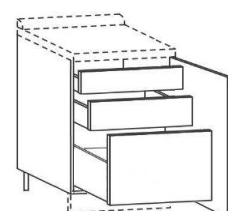

• BASE 1 DOOR + INTERNAL DRAWERS

With two internal drawers and deep drawer

◊ The base unit can be reduced in depth, without price surcharge up to 35cm



blum
LEGRABOX

Da/From **30 a/to 45**

B045B3

1.100	1.103	1.113	1.120	1.166	1.156	1.258	-	-			
-------	-------	-------	-------	-------	-------	-------	---	---	--	--	--

Da/From **46 a/to 65**

B065B3

1.218	1.225	1.238	1.245	1.314	1.281	1.386	-	-			
-------	-------	-------	-------	-------	-------	-------	---	---	--	--	--

BASI BASES

Prof. Depth **65**

Altezza Height **89**

• I prezzi NON comprendono maniglie, gole, top, alzatine e zoccolo • Prices do NOT included the handles, the groove, the worktop, the upstand and the plinth

Elemento Unit	Larghezza Width	Codice Code	1	2	3	4	5	6	7	8	9
---------------	-----------------	-------------	---	---	---	---	---	---	---	---	---

• BASE 1 ANTA CON CESTI INTERNI IN FILO METALLICO

Con due cesti estraibili indipendenti

◊ La base si può ridurre in profondità, senza maggiorazioni di prezzo fino a 58cm

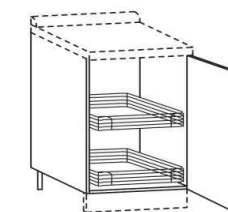

• BASE UNIT 1 DOOR AND BASKETS INSIDE IN METALLIC WIRE

With two independent pull-out baskets

◊ The base unit can be reduced in depth, without price increases up to 58cm



Largh./Width **40**

B040CE

846	850	860	863	906	902	1.001	-	-			
-----	-----	-----	-----	-----	-----	-------	---	---	--	--	--

Largh./Width **45**

B045CE

876	879	893	896	945	932	1.034	-	-			
-----	-----	-----	-----	-----	-----	-------	---	---	--	--	--

Largh./Width **60**

B060CE

972	981	991	998	1.067	1.037	1.143	-	-			
-----	-----	-----	-----	-------	-------	-------	---	---	--	--	--

• BASE CON CESTO PORTABOTTIGLIE IN FILO METALLICO

Cesto estraibile a due piani

◊ La base si può ridurre in profondità, senza maggiorazioni di prezzo fino a 58cm

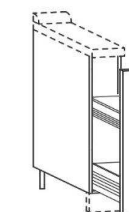

• BASE UNIT WITH METAL BOTTLE RACK IN METALLIC WIRE

Basket pull out with two shelves

◊ The base unit can be reduced in depth, without price increases up to 58cm

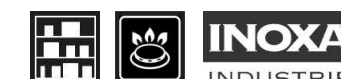

Largh./Width **15**

B015E

560	557	567	567	580	606	698	-	-			
-----	-----	-----	-----	-----	-----	-----	---	---	--	--	--

Largh./Width **20**

B020E

563	563	570	573	586	613	705	-	-			
-----	-----	-----	-----	-----	-----	-----	---	---	--	--	--

Largh./Width **30**

B030E

659	662	669	672	702	711	807	-	-			
-----	-----	-----	-----	-----	-----	-----	---	---	--	--	--

Largh./Width **40**

B040E

718	721	731	735	777	774	873	-	-			
-----	-----	-----	-----	-----	-----	-----	---	---	--	--	--

• BASE 1 ANTA ESTRAIBILE

Con cassetto e un cassetto interno

◊ La base si può ridurre in profondità, senza maggiorazioni di prezzo fino a 40cm

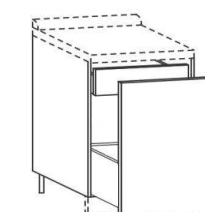

• BASE UNIT 1 PULL-OUT DOOR

Whith deep drawer an one inside drawer

◊ The base unit can be reduced in depth, without price increases up to 40cm



Da/From **30 a/to 45**

B045E1

863	869	879	883	932	922	1.024	-	-			
-----	-----	-----	-----	-----	-----	-------	---	---	--	--	--

Da/From **46 a/to 65**

B065E1

962	972	985	988	1.057	1.027	1.133	-	-			
-----	-----	-----	-----	-------	-------	-------	---	---	--	--	--

• BASE 1 ANTA ESTRAIBILE

Con cassetto e due cassetti interni

◊ La base si può ridurre in profondità, senza maggiorazioni di prezzo fino a 40cm

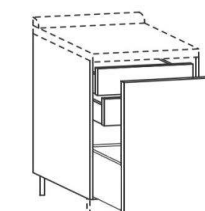

• BASE UNIT 1 PULL-OUT DOOR

Whith deep drawer an two inside drawers

◊ The base unit can be reduced in depth, without price increases up to 40cm



Da/From **30 a/to 45**

B045E2

1.031	1.037	1.047	1.050	1.100	1.087	1.189	-	-			
-------	-------	-------	-------	-------	-------	-------	---	---	--	--	--

Da/From **46 a/to 65**

B065E2

1.143	1.153	1.166	1.169	1.241	1.208	1.314	-	-			
-------	-------	-------	-------	-------	-------	-------	---	---	--	--	--

**BASI
BASES**

**Prof.
Depth 65**

**Altezza
Height 89**

• I prezzi NON comprendono maniglie, gole, top, alzatine e zoccolo • Prices do NOT included the handles, the groove, the worktop, the upstand and the plinth

Elemento Unit	Larghezza Width	Codice Code	1	2	3	4	5	6	7	8	9
------------------	--------------------	----------------	---	---	---	---	---	---	---	---	---

• **BASE 1 CASSETTO + 1 ANTA**

Con un ripiano interno

◊ La base si può ridurre in profondità, senza maggiorazioni di prezzo fino a 35cm

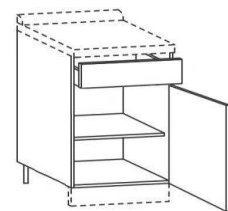

• **BASE UNIT 1 DRAWER + 1 DOOR**

With an shelf

◊ The base unit can be reduced in depth, without price increases up to 35cm



Da/From 20 a/to 45	B045C1										
Da/From 46 a/to 65	B065C1	715	718	728	735	781	800	896	-	-	
		810	817	830	837	906	906	1.001	-	-	

• **BASE 1 CASSETTO + 2 ANTE**

Con un ripiano interno

◊ La base si può ridurre in profondità, senza maggiorazioni di prezzo fino a 35cm

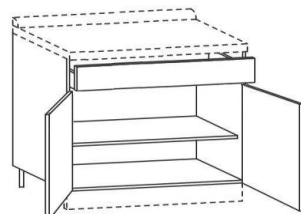

• **BASE UNIT 1 DRAWER + 2 DOORS**

With an shelf

◊ The base unit can be reduced in depth, without price increases up to 35cm



Da/From 60 a/to 95	B095C1										
Da/From 96 a/to 130	B130C1	1.070	1.080	1.100	1.110	1.205	1.222	1.399	-	-	
		1.271	1.287	1.314	1.324	1.462	1.442	1.623	-	-	

• **BASE 1 CASSETTO + 2 CASSETTONI**

◊ La base si può ridurre in profondità, senza maggiorazioni di prezzo fino a 35cm

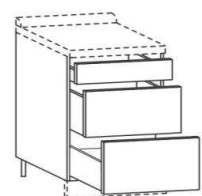

• **BASE 1 DRAWER + 2 DEEP DRAWERS**

◊ The base unit can be reduced in depth, without price increases up to 35cm



Da/From 20 a/to 45	B045C12	1.047	1.050	1.064	1.067	1.113	1.195	1.360	-	-	
Da/From 46 a/to 65	B065C12	1.159	1.169	1.179	1.185	1.255	1.327	1.492	-	-	
Da/From 66 a/to 95	B095C12	1.383	1.399	1.416	1.422	1.534	1.587	1.758	-	-	
Da/From 96 a/to 130	B130C12	1.617	1.643	1.659	1.669	1.821	1.854	2.031	-	-	

• **BASE 2 CASSETTI + 1 CASSETTONE**

◊ La base si può ridurre in profondità, senza maggiorazioni di prezzo fino a 35cm

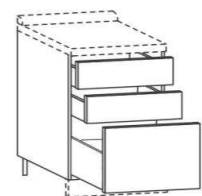

• **BASE 2 DRAWERS + 1 DEEP DRAWER**

◊ The base unit can be reduced in depth, without price increases up to 35cm



Da/From 20 a/to 45	B045C21	1.018	1.024	1.034	1.037	1.087	1.133	1.330	-	-	
Da/From 46 a/to 65	B065C21	1.129	1.139	1.149	1.156	1.225	1.258	1.343	-	-	
Da/From 66 a/to 95	B095C21	1.350	1.370	1.383	1.390	1.501	1.508	1.587	-	-	
Da/From 96 a/to 130	B130C21	1.580	1.607	1.623	1.633	1.788	1.765	1.840	-	-	

**BASI
BASES**

**Prof.
Depth 65**

**Altezza
Height 89**

• I prezzi NON comprendono maniglie, gole, top, alzatine e zoccolo • Prices do NOT included the handles, the groove, the worktop, the upstand and the plinth

Elemento Unit	Larghezza Width	Codice Code	1	2	3	4	5	6	7	8	9
------------------	--------------------	----------------	---	---	---	---	---	---	---	---	---

• **BASE 3 CASSETTI + 1 CASSETTONE**

◊ La base si può ridurre in profondità, senza maggiorazioni di prezzo fino a 35cm

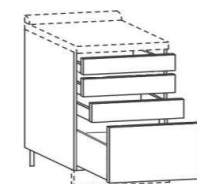

• **BASE 3 DRAWERS + 1 DEEP DRAWER**

◊ The base unit can be reduced in depth, without price increases up to 35cm



Da/From 20 a/to 45	B045C31	1.179	1.185	1.195	1.199	1.248	1.320	1.406	-	-	
Da/From 46 a/to 65	B065C31	1.304	1.314	1.324	1.330	1.399	1.462	1.541	-	-	
Da/From 66 a/to 95	B095C31	1.554	1.571	1.584	1.590	1.702	1.748	1.811	-	-	
Da/From 96 a/to 130	B130C31	1.811	1.834	1.854	1.860	2.015	2.041	2.091	-	-	

• **BASE 3 CASSETTONI**

◊ La base si può ridurre in profondità, senza maggiorazioni di prezzo fino a 35cm

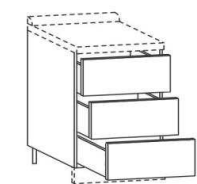

• **BASE 3 DEEP DRAWERS**

◊ The base unit can be reduced in depth, without price increases up to 35cm



Da/From 20 a/to 45	B045C3	1.027	1.031	1.041	1.047	1.093	1.215	1.449	-	-	
Da/From 46 a/to 65	B065C3	1.139	1.149	1.159	1.166	1.235	1.347	1.590	-	-	
Da/From 66 a/to 95	B095C3	1.363	1.383	1.396	1.403	1.515	1.613	1.880	-	-	
Da/From 96 a/to 130	B130C3	1.600	1.623	1.640	1.650	1.804	1.887	2.173	-	-	

• **BASE 2 CASSETTONI + CASSETTO INTERNO**

◊ La base si può ridurre in profondità, senza maggiorazioni di prezzo fino a 35cm

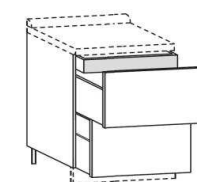

• **BASE 2 DEEP DRAWERS + INTERNAL DRAWER**

◊ The base unit can be reduced in depth, without price increases up to 35cm



Da/From 20 a/to 45	B045C2A	1.100	1.103	1.116	1.120	1.169	1.222	1.390	-	-	
Da/From 46 a/to 65	B065C2A	1.215	1.225	1.235	1.241	1.311	1.350	1.524	-	-	
Da/From 66 a/to 95	B095C2A	1.445	1.462	1.475	1.485	1.597	1.607	1.798	-	-	
Da/From 96 a/to 130	B130C2A	1.682	1.709	1.725	1.735	1.890	1.873	2.077	-	-	

• **BASE 2 CASSETTONI**

◊ La base si può ridurre in profondità, senza maggiorazioni di prezzo fino a 35cm

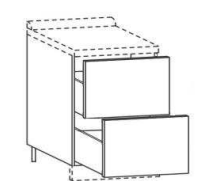

• **BASE 2 DEEP DRAWERS**

◊ The base unit can be reduced in depth, without price increases up to 35cm



Da/From 20 a/to 45	B045C2	932	939	948	952	1.001	1.054	1.222	-	-	
Da/From 46 a/to 65	B065C2	1.034	1.041	1.054	1.060	1.129	1.169	1.343	-	-	
Da/From 66 a/to 95	B095C2	1.232	1.251	1.264	1.271	1.383	1.396	1.584	-	-	
Da/From 96 a/to 130	B130C2	1.442	1.465	1.485	1.492	1.646	1.630	1.834	-	-	

BASI BASES

Prof. Depth **65**

Altezza Height **89**

• I prezzi NON comprendono maniglie, gole, top, alzatine e zoccolo • Prices do NOT included the handles, the groove, the worktop, the upstand and the plinth

Elemento Unit	Larghezza Width	Codice Code	1	2	3	4	5	6	7	8	9
---------------	-----------------	-------------	---	---	---	---	---	---	---	---	---

• BASE ANGOLARE 1 ANTA

Con due ripiani interni regolabili

◊ La base si può ridurre in profondità, senza maggiorazioni di prezzo fino a 35cm

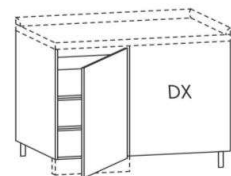

• CORNER BASE 1 DOOR

With two internal adjustable shelves

◊ The base unit can be reduced in depth, without price increases up to 35cm



Da/From **100x65** (anta 30)
a/to **135x65** (anta 65)

BA135A

			1.212	1.218	1.235	1.245	1.314	1.271	1.380	-	-

• BASE ANGOLARE 2 ANTE

Con due ripiani interni regolabili

◊ La base si può ridurre in profondità, senza maggiorazioni di prezzo fino a 35cm

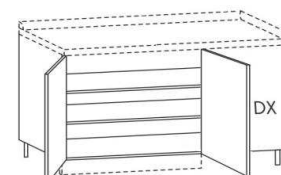

• CORNER BASE 2 DOORS

With two internal adjustable shelves

◊ The base unit can be reduced in depth, without price increases up to 35cm



Da/From **140x65** (anta 35)
a/to **160x65** (anta 45)

BA160B

			1.482	1.488	1.515	1.528	1.617	1.594	1.794	-	-

• BASE ANGOLARE 1 ANTA

Con meccanismo dotato di cesti estraibili a traino dell'anta

◊ La base si può ridurre in profondità, senza maggiorazioni di prezzo fino a 58cm

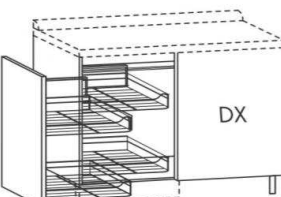

• CORNER BASE 1 DOOR

With mechanism equipped with removable baskets in tow wing

◊ The base unit can be reduced in depth, without price increases up to 58cm



Da/From **115x65** (anta 45)
a/to **125x65** (anta 60)

BA130CM

			1.561	1.567	1.587	1.594	1.656	1.620	1.725	-	-

• BASE ANGOLARE 1 ANTA

Con due cestelli indipendenti, estraibili e girevoli

◊ La base si può ridurre in profondità, senza maggiorazioni di prezzo fino a 58cm

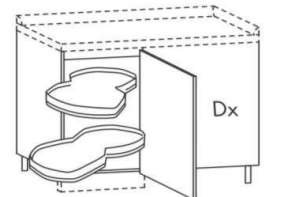

• CORNER BASE 1 DOOR

With two independent baskets, removable and rotatable

◊ The base unit can be reduced in depth, without price increases up to 58cm



Da/From **115x65** (anta 45)
a/to **125x65** (anta 60)

BA130N

			1.449	1.455	1.472	1.482	1.544	1.508	1.613	-	-

BASI BASES

Prof. Depth **65**

Altezza Height **89**

• I prezzi NON comprendono maniglie, gole, top, alzatine e zoccolo • Prices do NOT included the handles, the groove, the worktop, the upstand and the plinth

Elemento Unit	Larghezza Width	Codice Code	1	2	3	4	5	6	7	8	9
---------------	-----------------	-------------	---	---	---	---	---	---	---	---	---

• BASE ANGOLARE 1 ANTA

Con due cestelli indipendenti, estraibili e girevoli

◊ La base si può ridurre in profondità, senza maggiorazioni di prezzo fino a 55cm

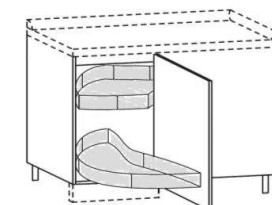

• CORNER BASE 1 DOOR

With two independent baskets, removable and rotatable

◊ The base unit can be reduced in depth, without price increases up to 40cm



Da/From **115x65** (anta 45)
a/to **125x65** (anta 60)

BA130C

			1.225	1.232	1.248	1.258	1.320	1.284	1.390	-	-

• BASE ANGOLARE CAPIENTE 2 ANTE

Con due ripiani interni regolabili

◊ La base si può ridurre in profondità, senza maggiorazioni di prezzo fino a 35cm

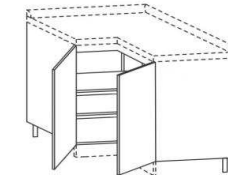

• LARGE CORNER BASE 1 DOOR

Whith two internal adjustable shelves

◊ The base unit can be reduced in depth, without price increases up to 35cm



Da/From **100x100** (anta 30)
a/to **135x135** (anta 65)

BA135C

			1.896	1.916	1.943	1.952	2.104	2.028	2.242	-	-

• BASE 2 ANTE SCORREVOLI A FILO (COMPLANARI)

Con fianco divisorio e quattro ripiani regolabili

◊ La base si può ridurre in profondità, senza maggiorazioni di prezzo fino a 35cm

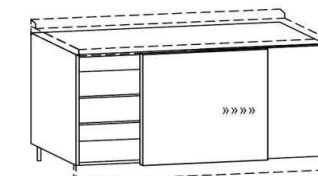

• BASE UNIT WITH 2 SLIDING DOORS IN LINE (COMPLANAR)

With side attached home and four adjustable shelves

◊ The base unit can be reduced in depth, without price increases up to 35cm



Largh./Width **120**
Largh./Width **160**

B120S

B160S

			2.897	2.917	2.940	2.950	3.091	3.029	3.239	-	-
			3.190	3.210	3.233	3.243	3.381	3.318	3.529	-	-

• BASE A GIORNO IN ESSENZA CON TELAIO FRONTALE A FILO

Con due ripiani regolabili

◊ La base si può ridurre in profondità, senza maggiorazioni di prezzo fino a 35cm

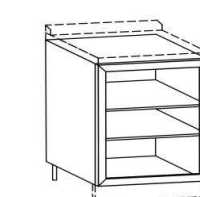

• OPEN BASE UNIT IN ESSENCE WITH FRAME FRONT

With two adjustable shelves

◊ The base unit can be reduced in depth, without price increases up to 35cm



Da/From **20** a/to **45** **B045G**
Da/From **46** a/to **65** **B065G**
Da/From **66** a/to **95** **B095G**
Da/From **96** a/to **130** **B130G**

			-	626	-	-	646	629	629	-	-
			-	708	-	-	735	702	715	-	-
			-	873	-	-	909	883	883	-	-
			-	1.050	-	-	1.097	1.064	1.064	-	-

BASI PER PIANO COTTURA E FORNO BASES UNITS FOR OVEN AND HOB

Prof. **65**
Depth

Altezza **89**
Height

• I prezzi NON comprendono maniglie, gole, top, alzatine e zoccolo • Prices do NOT included the handles, the groove, the worktop, the upstand and the plinth

Elemento Unit	Larghezza Width	Codice Code	1	2	3	4	5	6	7	8	9
------------------	--------------------	----------------	---	---	---	---	---	---	---	---	---

• BASE PER FORNO H.60

Con frontalino fisso e solo frontale cassetto fisso nella parte bassa

◊ La base si può ridurre in profondità, senza maggiorazioni di prezzo fino a 58cm

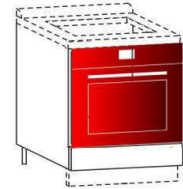

• BASE UNIT FOR OVEN H.60

With faceplate fixed and front drawer panel fixed down

◊ The base unit can be reduced in depth, without price increases up to 58cm

Largh./Width 60	BF060	435	435	442	445	451	451	451	-	-
Largh./Width 76	BF076	481	478	488	491	501	501	494	-	-
Largh./Width 90	BF090	527	524	534	537	553	553	540	-	-



• BASE PER FORNO H.60 + CASSETTO

Con frontalino fisso e cassetto in basso

◊ La base si può ridurre in profondità, senza maggiorazioni di prezzo fino a 58cm

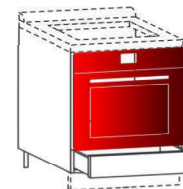

• BASE UNIT FOR OVEN H.60+DRAWER

With fixed bezel and bottom drawer

◊ The base unit can be reduced in depth, without price increases up to 58cm

Largh./Width 60	BF060C	609	609	616	619	626	626	626	-	-
Largh./Width 76	BF076C	669	665	675	679	692	688	682	-	-
Largh./Width 90	BF090C	728	728	735	738	754	754	741	-	-



• BASE PER FORNO H.48 + CASSETTO

Con frontale cassetto fisso in alto e cassetto in basso

◊ La base si può ridurre in profondità, senza maggiorazioni di prezzo fino a 58cm

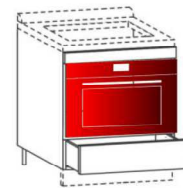

• BASE UNIT FOR OVEN H.60+DRAWER

With fixed front drawer in the top and bottom drawer

◊ The base unit can be reduced in depth, without price increases up to 58cm

Largh./Width 60	BM060C	688	685	695	705	711	741	820	-	-
Largh./Width 76	BM076C	754	751	764	771	787	814	896	-	-
Largh./Width 90	BM090C	823	817	837	840	863	889	972	-	-



• BASE PER FORNO H.60 + CASSETTO

Con cassetto in alto e frontalino fisso in basso

◊ La base si può ridurre in profondità, senza maggiorazioni di prezzo fino a 58cm

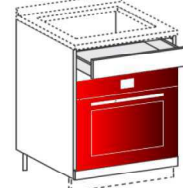

• BASE UNIT FOR OVEN H.60+DRAWER

With the upper and lower fixed drawer front

◊ The base unit can be reduced in depth, without price increases up to 58cm

Largh./Width 60	BF060CS	639	632	642	652	642	649	642	-	-
Largh./Width 76	BF076CS	698	692	705	711	708	711	702	-	-
Largh./Width 90	BF090CS	761	751	767	771	774	777	761	-	-



BASI PER LAVELLO SINK BASES UNITS

Prof. **65**
Depth

Altezza **89**
Height

• I prezzi NON comprendono maniglie, gole, top, alzatine e zoccolo • Prices do NOT included the handles, the groove, the worktop, the upstand and the plinth

Elemento Unit	Larghezza Width	Codice Code	1	2	3	4	5	6	7	8	9
------------------	--------------------	----------------	---	---	---	---	---	---	---	---	---

• BASE LAVELLO 1 ANTA

Fondo rivestito con stratificato Hpl finitura titanio

◊ La base si può ridurre in profondità, senza maggiorazioni di prezzo fino a 58 cm

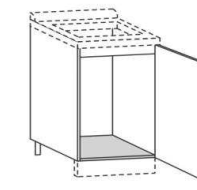

• SINK BASE UNIT WITH 1 DOOR

Bottom covered with laminated Hpl titanium finish

◊ The base unit can be reduced in depth, without price increases up to 58 cm

Da/From 40 a/to 65	BL065	544	553	563	570	639	606	711	-	-
---------------------------	--------------	-----	-----	-----	-----	-----	-----	-----	---	---



• BASE LAVELLO 2 ANTE

Fondo rivestito con stratificato Hpl finitura titanio

◊ La base si può ridurre in profondità, senza maggiorazioni di prezzo fino a 58 cm

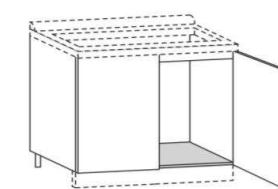

• SINK BASE UNIT WITH 2 DOORS

Bottom covered with laminated Hpl titanium finish

◊ The base unit can be reduced in depth, without price increases up to 58 cm

Da/From 60 a/to 95	BL095	748	758	777	787	883	863	1.064	-	-
Da/From 96 a/to 130	BL130	869	889	912	925	1.064	1.001	1.212	-	-



• BASE LAVELLO 2 CASSETTONI

Fondo rivestito in stratificato Hpl, con cassetto superiore portaspugne e inferiore per kit pattumiere opzionali

◊ La base si può ridurre in profondità, senza maggiorazioni di prezzo fino a 58 cm
◊ Kit pattumiere per cassetto inferiore non compreso

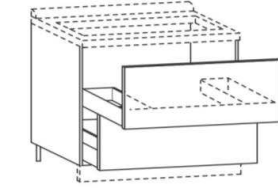

• SINK BASE UNIT 2 DEEP DRAWERS

Bottom covered with laminated Hpl, with upper drawer for sponges and lower for optional kit dustbins

◊ The base unit can be reduced in depth, without price increases up to 58 cm
◊ Kit for dustbins for lower drawer not included

Da/From 45 a/to 65	BL065C	1.034	1.044	1.057	1.060	1.129	1.172	1.347	-	-
Da/From 66 a/to 95	BL095C	1.218	1.235	1.248	1.255	1.366	1.380	1.571	-	-
Da/From 96 a/to 130	BL130C	1.406	1.432	1.449	1.459	1.613	1.597	1.801	-	-



• BASE LAVELLO 2 CASSETTONI

Fondo rivestito in stratificato Hpl, con cesto superiore portaspugne in filo cromato e inferiore per kit pattumiere opzionali

◊ La base si può ridurre in profondità, senza maggiorazioni di prezzo fino a 58 cm
◊ Kit pattumiere per cassetto inferiore non compreso

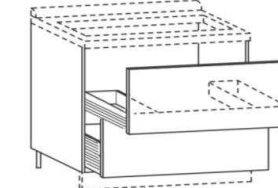

• SINK BASE UNIT 2 DEEP DRAWERS

Bottom covered with laminated Hpl, with upper basket in chrome wire for sponges and lower for mounting optional kit dustbins

◊ The base unit can be reduced in depth, without price increases up to 58 cm
◊ Kit for dustbins for lower drawer not included

Largh./Width 60	BL060CE	916	925	939	942	1.014	1.054	1.228	-	-
Largh./Width 80	BL080CE	1.011	1.024	1.037	1.047	1.143	1.166	1.350	-	-
Largh./Width 90	BL090CE	1.057	1.074	1.090	1.097	1.208	1.218	1.409	-	-
Largh./Width 120	BL120CE	1.228	1.255	1.271	1.281	1.436	1.419	1.623	-	-



ELEMENTI PER ELETTRODOMESTICI
COMPONENTS FOR APPLIANCES

Prof. **65**
Depth

Altezza **89**
Height

• I prezzi NON comprendono maniglie, gole, top, alzatine e zoccolo • Prices do NOT included the handles, the groove, the worktop, the upstand and the plinth

Elemento Unit	Larghezza Width	Codice Code	1	2	3	4	5	6	7	8	9
------------------	--------------------	----------------	---	---	---	---	---	---	---	---	---

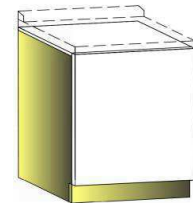

• **ANTA PER LAVASTOVIGLIE INCASSO**
Elemento composto da un pannello strutturale sottotop, e anta per lavastoviglie incasso con comandi a scomparsa e per zoccolo h.8 cm

• **DISHWASHER DOOR**
Fully recessed built-in. Includes also the supply of spacer wood under top and for plinth h.8 cm

 DI SERIE ZOCCOLO H.8 STANDARD PLINTH H.8	Largh./Width 45	AS045									
	Largh./Width 60	AS060	254	257	270	274	323	310	412	-	-
			316	323	336	343	412	379	484	-	-

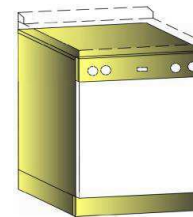

• **ANTA PER LAVASTOVIGLIE INCASSO**
Elemento composto da un pannello strutturale sottotop, e anta per lavastoviglie incasso con comandi a vista

• **DISHWASHER DOOR**
Built-in with visible dashboard. Includes also the supply of spacer wood under top

 DI SERIE ZOCCOLO H.8 STANDARD PLINTH H.8	Largh./Width 45	AS045V									
	Largh./Width 60	AS060V	237	241	251	254	293	293	389	-	-
			316	323	336	343	412	379	484	-	-

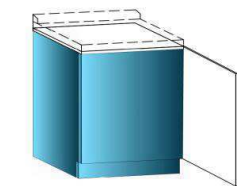

• **ANTA PER FRIGO INCASSO**
Elemento composto da un pannello sottotop e anta per frigo/congelatore incasso dotato di porta sulla quale agganciare direttamente l'anta

• **FRIDGE DOOR**
Self-ventilated under top. Includes also the supply of spacer wood under top

 DI SERIE ZOCCOLO H.8 STANDARD PLINTH H.8	Largh./Width 60	AF060									
			316	323	336	343	412	379	484	-	-

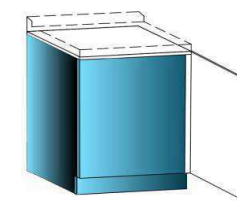

• **ANTA + FIANCO PER FRIGO INCASSO**
Elemento composto da un pannello sottotop, fianco strutturale e anta con cerniere per frigo/congelatore incasso dotato di porta a traino

• **FRIDGE DOOR + SIDE FOR BASE**
Self-ventilated under top. Includes also the supply of spacer wood under top and side for base

 DI SERIE ZOCCOLO H.8 STANDARD PLINTH H.8	Largh./Width 60	AF060FIA									
			432	442	451	458	527	498	603	-	-

ELEMENTI PER ELETTRODOMESTICI
COMPONENTS FOR APPLIANCES

Prof. **65**
Depth

Altezza **89**
Height

• I prezzi NON comprendono maniglie, gole, top, alzatine e zoccolo • Prices do NOT included the handles, the groove, the worktop, the upstand and the plinth

Elemento Unit	Larghezza Width	Codice Code	1	2	3	4	5	6	7	8	9
------------------	--------------------	----------------	---	---	---	---	---	---	---	---	---

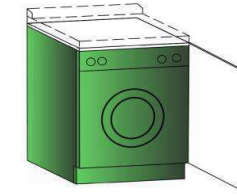

• **ANTA PER LAVATRICE INCASSO**
Elemento composto da un pannello sottotop, e anta da montare direttamente sulle cerniere della lavatrice incasso con comandi a scomparsa

• **WASHING MACHINE DOOR**
Fully recessed built-in. Includes also the supply of spacer wood under top

 DI SERIE ZOCCOLO H.8 STANDARD PLINTH H.8	Largh./Width 60	AT060									
			316	323	336	343	412	379	484	-	-

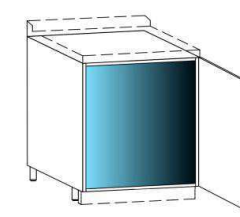

• **BASE 1 ANTA PER FRIGO INCASSO**
Struttura senza schiena, per frigo/congelatore incasso dotato di porta a traino

• **BASE WITH FRIDGE DOOR**
Self-ventilated under top. Base with door, without door and without back

	Largh./Width 60	BFRI060									
			586	596	606	613	682	652	758	-	-

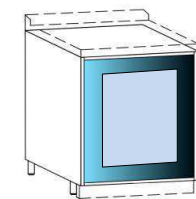

• **BASE PER FRIGO CANTINA**
Struttura fusto, senza anta e senza schiena

• **BASE FOR FRIDGE WINE CELLAR**
Base, without door and without back

	Largh./Width 60	BCAN060									
			445	442	448	451	445	448	448	-	-

FASCIE DI TAMPONAMENTO LATERALE E FIANCHI A VISTA PER BASI SIDE FINISHER AND FINISHING SIDE FOR BASES

• I prezzi NON comprendono lo zoccolo • Prices do NOT included the plinth

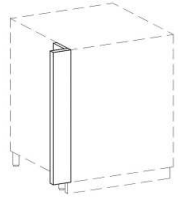
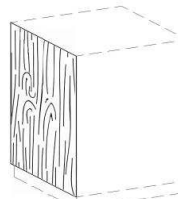
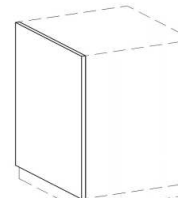
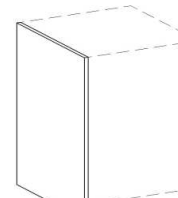
Elemento Unit	Altezza Hight	Codice Code	1	2	3	4	5	6	7	8	9	
	• FASCIA DI TAMPONAMENTO LATERALE PER BASI											
	Larghezza 2÷15 cm											
	• SIDE FINISHER FOR BASES											
			Width 2÷15 cm									
	Altezza/Hight 81	TB081	73	63	76	79	70	70	70	76	-	
	Altezza/Hight 54	TB054	60	53	63	66	53	56	56	60	-	
	• SUPPLEMENTO PER FIANCO PERSONALIZZATO BASE											
	• SURCHARGE FOR PERSONALIZED SIDE PANEL BASE											
		H.81 - Da/From 35 a/to 65	FWB081A	129	116	149	178	182	116	116	116	-
		H.81 - Da/From 66 a/to 130	FWB081B	211	205	251	316	402	205	205	205	-
		H.54 - Da/From 35 a/to 65	FWB054A	103	89	116	129	139	89	89	89	-
	H.54 - Da/From 66 a/to 130	FWB054B	158	145	185	221	270	145	145	145	-	
	• FIANCO DI FINITURA A RIPORTO PER BASE (SOSPESO)											
	Spessore 2cm											
	• CARRIED OVER FINISHING SIDE FOR BASE (SUSPENDED)											
				Thickness 2cm								
		H.81 - Da/From 35 a/to 65	FRB081A	172	188	198	237	297	188	188	188	-
	H.81 - Da/From 66 a/to 130	FRB081B	300	333	353	422	567	333	333	333	-	
	H.54 - Da/From 35 a/to 65	FRB054A	129	139	149	172	208	139	139	139	-	
	H.54 - Da/From 66 a/to 130	FRB054B	221	241	254	297	389	241	241	241	-	
	• FIANCO DI FINITURA A RIPORTO PER BASE (FINO A TERRA)											
	Spessore 2cm											
	• CARRIED OVER FINISHING SIDE FOR BASE (DOWN TO THE GROUND)											
				Thickness 2cm								
		H.89 - Da/From 35 a/to 65	FRB089A	185	201	211	257	326	201	201	201	-
	H.89 - Da/From 66 a/to 130	FRB089B	326	363	379	461	619	363	363	363	-	
	H.62 - Da/From 35 a/to 65	FRB062A	142	152	162	191	234	152	152	152	-	
	H.62 - Da/From 66 a/to 130	FRB062B	244	267	284	333	442	267	267	267	-	

OPZIONI PER BASI OPTIONS FOR BASES UNITS

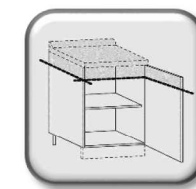

- SUPPLEMENTO PER RIDUZIONE MOBILE IN ALTEZZA
- SURCHARGE FOR REDUCTION HEIGHT OF A FURNITURE

Per ogni base/For each base unit

OPZHB

37

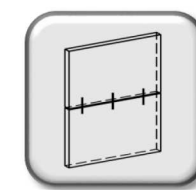

- SUPPLEMENTO PER ANTA COMPOSTA DA DUE FRONTALI UNITI TRA LORO
- SURCHARGE FOR DOOR COMPOSED BY TWO JOINED TOGETHER FRONTS

Per ogni anta/For each door

OPZAU

47

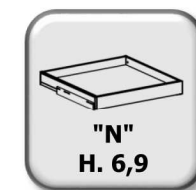

- CASSETTO INTERNO LEGRABOX-N O LEGNO (INGOMBRO MINIMO H.8)
 - DRAWER INTERNAL LEGRABOX-N (MINIMUM ENCUMBRANCE H.8)
- Profondità e portata in base alle misure del vano o su specifica richiesta
The depth depends on the measures of the compartment or on special request

CASSETTO LEGRABOX
Largh. da/Width from **20 a/to 95**

CASSETTO IN LEGNO
Largh. da/Width from **20 a/to 95**

OPZLGR_N

198

OPZLGN_N

214

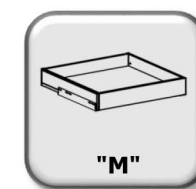

- CASSETTO INTERNO LEGRABOX-M O LEGNO (INGOMBRO MINIMO H.10,4)
 - DRAWER INTERNAL LEGRABOX-M (MINIMUM ENCUMBRANCE H.10,4)
- Profondità e portata in base alle misure del vano o su specifica richiesta
The depth depends on the measures of the compartment or on special request

CASSETTO LEGRABOX
Largh. da/Width from **20 a/to 95**

CASSETTO IN LEGNO
Largh. da/Width from **20 a/to 95**

OPZLGR_M

195

OPZLGN_M

224

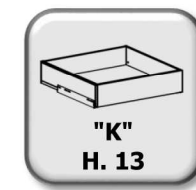

- CASSETTO INTERNO LEGRABOX-K O LEGNO (INGOMBRO MINIMO H.14,4)
 - DRAWER INTERNAL LEGRABOX-K (MINIMUM ENCUMBRANCE H.14,4)
- Profondità e portata in base alle misure del vano o su specifica richiesta
The depth depends on the measures of the compartment or on special request

CASSETTO LEGRABOX
Largh. da/Width from **20 a/to 95**

CASSETTO IN LEGNO
Largh. da/Width from **20 a/to 95**

OPZLGR_K

218

OPZLGN_K

237

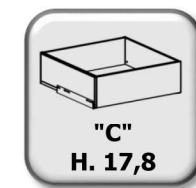

- CASSETTO INTERNO LEGRABOX-C O LEGNO (INGOMBRO MINIMO H.19,3)
 - DRAWER INTERNAL LEGRABOX-C (MINIMUM ENCUMBRANCE H.19,3)
- Profondità e portata in base alle misure del vano o su specifica richiesta
The depth depends on the measures of the compartment or on special request

CASSETTO LEGRABOX
Largh. da/Width from **20 a/to 95**

CASSETTO IN LEGNO
Largh. da/Width from **20 a/to 95**

OPZLGR_C

231

OPZLGN_C

257

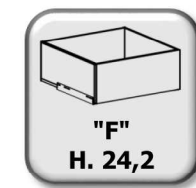

- CASSETTO INTERNO LEGRABOX-F O LEGNO (INGOMBRO MINIMO H.19,3)
 - DRAWER INTERNAL LEGRABOX-F (MINIMUM ENCUMBRANCE H.19,3)
- Profondità e portata in base alle misure del vano o su specifica richiesta
The depth depends on the measures of the compartment or on special request

CASSETTO LEGRABOX
Largh. da/Width from **20 a/to 95**

CASSETTO IN LEGNO
Largh. da/Width from **20 a/to 95**

OPZLGR_F

284

OPZLGN_F

284

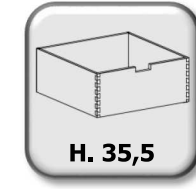

- CASSETTONE "ONLYWOOD" IN LUCE REALIZZATO IN ESSENZA CON INCASTRI A VISTA PER BASI A GIORNO CON TELAIO (H.35,5)
- DEEP DRAWER INTERNAL MADE IN ESSENCE WITH JOINTS EXPOSED "ONLYWOOD" BASIS FOR A DAY WITH FRAME (H.35,5)

CASSETTO IN LEGNO
Largh. da/Width from **20 a/to 65**

Largh. da/Width from **66 a/to 95**

OPZONL1

392

OPZONL2

437



COLONNE
TALL UNITS

COLONNE DISPENSA
TALL LARDER UNITS

Prof. Depth **65**

Altezza Height **149**

• I prezzi NON comprendono maniglie, gole e zoccolo • Prices do NOT included the handles, the groove and the plinth

Elemento Unit	Larghezza Width	Codice Code	1	2	3	4	5	6	7	8	9
---------------	-----------------	-------------	---	---	---	---	---	---	---	---	---

• **COLONNA 1 ANTA**

Con tre ripiani interni regolabili

◊ La colonna si può ridurre in profondità, senza maggiorazioni di prezzo fino a 35cm

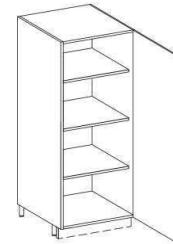

• **TALL UNIT 1 DOOR**

With three internal adjustable shelves

◊ The tall unit can be reduced in depth, without price surcharge up to 35cm



Da/From **20 a/to 45**

C1D045

Da/From **46 a/to 65**

C1D065

• **COLONNA 1 ANTA SOPRA LAVASTOVIGLIE**

Con ripiano interno regolabile

◊ La colonna si può ridurre in profondità, senza maggiorazioni di prezzo fino a 58cm

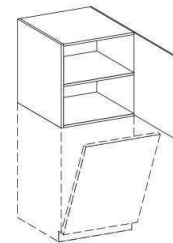

• **TALL UNIT WITH DOOR ABOVE A DISHWASHER**

With internal adjustable shelf

◊ The tall unit can be reduced in depth, without price surcharge up to 58cm



Largh./Width **45**

C1D045H

Largh./Width **60**

C1D060H

• **COLONNA 1 ANTA PER FRIGORIFERO-CONGELATORE**

Con ripiano interno regolabile

◊ La colonna si può ridurre in profondità, senza maggiorazioni di prezzo fino a 58cm

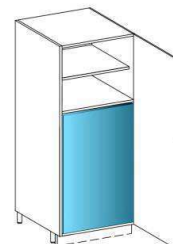

• **TALL UNIT 1 DOOR FOR REFRIGERATOR AND FREEZER**

With internal adjustable shelf

◊ The tall unit can be reduced in depth, without price surcharge up to 58cm



130Lt. 147Lt. 172Lt.

Largh./Width **60**

C1FR060

• **COLONNA 1 ANTA PER FORNO**

Con due ripiani interni regolabili

◊ La colonna si può ridurre in profondità, senza maggiorazioni di prezzo fino a 58cm



• **TALL UNIT 1 DOOR FOR OVEN**

With two internal adjustable shelves

◊ The tall unit can be reduced in depth, without price surcharge up to 58cm



Largh./Width **60**

C1F060

COLONNE DISPENSA
TALL LARDER UNITS

Prof. Depth **65**

Altezza Height **149**

• I prezzi NON comprendono maniglie, gole e zoccolo • Prices do NOT included the handles, the groove and the plinth

Elemento Unit	Larghezza Width	Codice Code	1	2	3	4	5	6	7	8	9
---------------	-----------------	-------------	---	---	---	---	---	---	---	---	---

• **COLONNA 1 ANTA ESTRAIBILE PER FORNO**

Con cassettoni e un cassetto interno

◊ La colonna si può ridurre in profondità, senza maggiorazioni di prezzo fino a 58cm



• **TALL UNIT 1 PULL-OUT DOOR FOR OVEN**

With deep drawer and one inside drawer

◊ The tall unit can be reduced in depth, without price surcharge up to 58cm



Largh./Width **60**

C1F060E1

• **COLONNA 2 CASSETTONI PER FORNO**

◊ La colonna si può ridurre in profondità, senza maggiorazioni di prezzo fino a 58cm

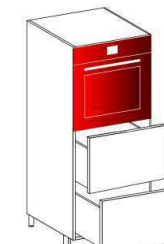

• **TALL UNIT 2 DEEP DRAWERS FOR OVEN**

◊ The tall unit can be reduced in depth, without price surcharge up to 58cm



Largh./Width **60**

C1F060C2

• **COLONNA SOPRALAVASTOVIGLIE PER FORNO**

◊ La colonna si può ridurre in profondità, senza maggiorazioni di prezzo fino a 58cm

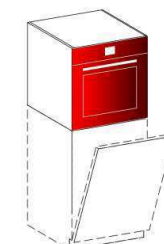

• **TALL UNIT ABOVE A DISHWASHER FOR OVEN**

◊ The tall unit can be reduced in depth, without price surcharge up to 58cm



Largh./Width **60**

C1F060H

• **COLONNA 1 CASSETTO PER FORNO + FORNO MICROONDE**

◊ La colonna si può ridurre in profondità, senza maggiorazioni di prezzo fino a 58 cm

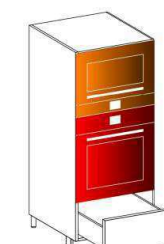

• **TALL UNIT ONE DRAWER FOR OVEN + MICROWAVE**

◊ The tall unit can be reduced in depth, without price surcharge up to 58 cm



Largh./Width **60**

C1FM060C

COLONNE DISPENSA
TALL LARDER UNITS

Prof. **65**
Depth

Altezza **212**
Height

• I prezzi NON comprendono maniglie, gole e zoccolo • Prices do NOT included the handles, the groove and the plinth

Elemento Unit	Larghezza Width	Codice Code	1	2	3	4	5	6	7	8	9
---------------	-----------------	-------------	---	---	---	---	---	---	---	---	---

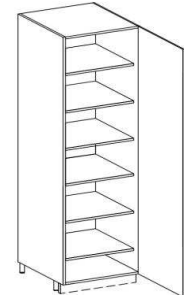

• **COLONNA 1 ANTA**

Con cinque ripiani interni regolabili

◊ La colonna si può ridurre in profondità, senza maggiorazioni di prezzo fino a 35cm

• **TALL UNIT 1 DOOR**

With five internal adjustable shelves

◊ The tall unit can be reduced in depth, without price surcharge up to 35cm

Da/From 20 a/to 45	C2D045A1										
Da/From 46 a/to 65	C2D065A1	1.311	1.327	1.350	1.360	1.498	1.399	1.551	-	-	
		1.531	1.561	1.584	1.600	1.791	1.630	1.788	-	-	

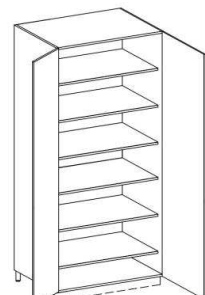

• **COLONNA 2 ANTE**

Con cinque ripiani interni regolabili

◊ La colonna si può ridurre in profondità, senza maggiorazioni di prezzo fino a 35cm

• **TALL UNIT 2 DOORS**

With five internal adjustable shelves

◊ The tall unit can be reduced in depth, without price surcharge up to 35cm

Da/From 60 a/to 95	C2D095A2	2.114	2.153	2.193	2.216	2.489	2.291	2.601	-	-	
Da/From 96 a/to 130	C2D130A2	2.574	2.637	2.680	2.716	3.091	2.772	3.091	-	-	

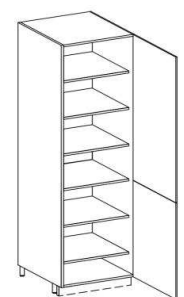

• **COLONNA 2 ANTE**

Con cinque ripiani interni regolabili

◊ La colonna si può ridurre in profondità, senza maggiorazioni di prezzo fino a 35cm

• **TALL UNIT 2 DOORS**

With five internal adjustable shelves

◊ The tall unit can be reduced in depth, without price surcharge up to 35cm

Da/From 20 a/to 45	C2D045A2	1.327	1.347	1.366	1.380	1.515	1.482	1.702	-	-	
Da/From 46 a/to 65	C2D065A2	1.551	1.580	1.603	1.620	1.808	1.719	1.949	-	-	

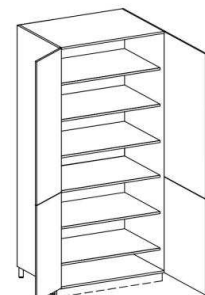

• **COLONNA 4 ANTE**

Con cinque ripiani interni regolabili

◊ La colonna si può ridurre in profondità, senza maggiorazioni di prezzo fino a 35cm

• **TALL UNIT 4 DOORS**

With five internal adjustable shelves

◊ The tall unit can be reduced in depth, without price surcharge up to 35cm

Da/From 60 a/to 95	C2D095A4	2.150	2.189	2.232	2.252	2.525	2.459	2.900	-	-	
Da/From 96 a/to 130	C2D130A4	2.611	2.673	2.719	2.752	3.127	2.950	3.407	-	-	



COLONNE DISPENSA
TALL LARDER UNITS

Prof. **65**
Depth

Altezza **212**
Height

• I prezzi NON comprendono maniglie, gole e zoccolo • Prices do NOT included the handles, the groove and the plinth

Elemento Unit	Larghezza Width	Codice Code	1	2	3	4	5	6	7	8	9
---------------	-----------------	-------------	---	---	---	---	---	---	---	---	---

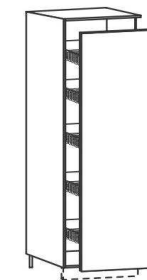

• **COLONNA 1 ANTA ESTRAIBILE**

Meccanismo estraibile attrezzato con sei cestelli in finitura titanio regolabili in altezza

◊ La colonna si può ridurre in profondità, senza maggiorazioni di prezzo fino a 58cm

• **TALL UNIT 1 PULL-OUT DOOR**

Pull-out mechanism equipped with six basket titanium finish adjustable-height

◊ The tall unit can be reduced in depth, without price surcharge up to 58cm

Largh./Width 30	C2030E	1.495	1.501	1.521	1.524	1.610	1.574	1.722	-	-	
Largh./Width 40	C2040E	1.590	1.607	1.627	1.633	1.755	1.676	1.827	-	-	
Largh./Width 45	C2045E	1.646	1.666	1.686	1.696	1.834	1.735	1.890	-	-	
Largh./Width 60	C2060E	1.719	1.735	1.755	1.765	1.883	1.804	1.959	-	-	

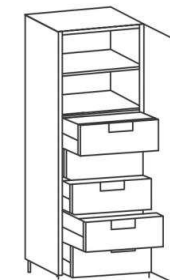

• **COLONNA 1 ANTA APERTURA 155°**

Con cinque cesti in filo metallico, estraibili e indipendenti

◊ La colonna si può ridurre in profondità, senza maggiorazioni di prezzo fino a 58cm

• **TALL UNIT 1 DOOR OPEN 155°**

With five baskets removable and independent wire baskets

◊ The tall unit can be reduced in depth, without price surcharge up to 35cm

Largh./Width 45	C2045CE	1.854	1.870	1.893	1.903	2.041	1.943	2.094	-	-	
Largh./Width 60	C2060CE	2.074	2.104	2.127	2.143	2.331	2.170	2.331	-	-	

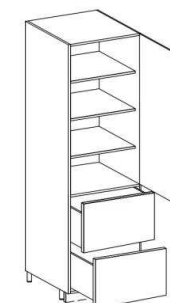

• **COLONNA 1 ANTA + 2 CASSETTONI**

Con tre ripiani interni regolabili

◊ La colonna si può ridurre in profondità, senza maggiorazioni di prezzo fino a 35cm

• **TALL UNIT 1 DOOR + 2 DEEP DRAWERS**

With three internal adjustable shelves

◊ The tall unit can be reduced in depth, without price surcharge up to 35cm

Da/From 20 a/to 45	C2D045C2	1.636	1.656	1.676	1.686	1.824	1.788	2.008	-	-	
Da/From 45 a/to 65	C2D065C2	1.860	1.890	1.913	1.933	2.120	2.031	2.258	-	-	

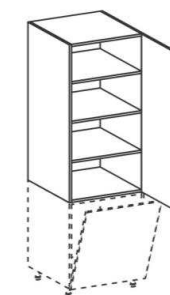

• **COLONNA 1 ANTA SOPRA LAVASTOVIGLIE**

Con tre ripiani interni regolabili

◊ La colonna si può ridurre in profondità, senza maggiorazioni di prezzo fino a 58 cm

• **TALL UNIT WITH DOOR ABOVE A DISHWASHER**

With three internal adjustable shelves

◊ The tall unit can be reduced in depth, without price surcharge up to 58 cm

Da/From 20 a/to 45	C2D045H	873	883	896	906	981	942	1.060	-	-	
Da/From 45 a/to 65	C2D060H	1.008	1.027	1.041	1.054	1.159	1.087	1.208	-	-	







COLONNE DISPENSA
TALL LARDER UNITS

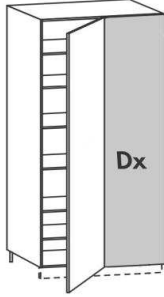

Prof. Depth **65**

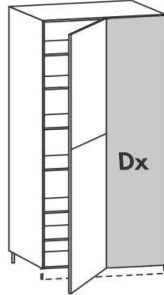

Altezza Height **212**

• I prezzi NON comprendono maniglie, gole e zoccolo • Prices do NOT included the handles, the groove and the plinth

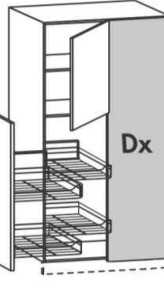
Elemento Unit	Larghezza Width	Codice Code	1	2	3	4	5	6	7	8	9
 <p>• COLONNA ANGOLARE 1 ANTA Con cinque ripiani interni regolabili</p> <p>◇ La colonna si può ridurre in profondità, senza maggiorazioni di prezzo fino a 35cm</p>											
 <p>• CORNER TALL UNIT 1 DOOR With five internal adjustable shelves</p> <p>◇ The tall unit can be reduced in depth, without price surcharge up to 35cm</p>											
	Da/From 115x65 (anta 45) a/to 130x65 (anta 60)	C2A130A	2.515	2.532	2.574	2.591	2.785	2.607	2.765	-	-

 <p>• COLONNA ANGOLARE 2 ANTE Con cinque ripiani interni regolabili</p> <p>◇ La colonna si può ridurre in profondità, senza maggiorazioni di prezzo fino a 35cm</p>											
 <p>• CORNER TALL UNIT 2 DOORS With five internal adjustable shelves</p> <p>◇ The tall unit can be reduced in depth, without price surcharge up to 35cm</p>											
	Da/From 115x65 (anta 45) a/to 130x65 (anta 60)	C2A130B	2.542	2.558	2.601	2.617	2.808	2.703	2.933	-	-

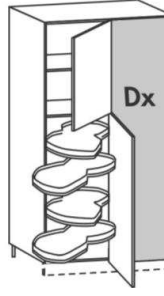
 <p>• COLONNA ANGOLARE 2 ANTE Con 2 ripiani interni regolabili con meccanismo dotato di cesti estraibili a traino dell'anta</p> <p>◇ La colonna si può ridurre in profondità, senza maggiorazioni di prezzo fino a 58 cm</p>											
 <p>• CORNER TALL UNIT 2 DOORS With two internal adjustable shelves with mechanism equipped with removable baskets in tow wing</p> <p>◇ The tall unit can be reduced in depth, without price surcharge up to 58 cm</p>											
	Da/From 115x65 (anta 45) a/to 130x65 (anta 60)	C2A130CM	3.338	3.355	3.397	3.411	3.605	3.499	3.727	-	-



 <p>• COLONNA ANGOLARE 2 ANTE Con 2 ripiani interni regolabili con due cestelli indipendenti, estraibili e girevoli</p> <p>◇ La colonna si può ridurre in profondità, senza maggiorazioni di prezzo fino a 58cm</p>											
 <p>• CORNER TALL UNIT 2 DOORS With two internal adjustable shelves with two independent baskets, removable and rotatable</p> <p>◇ The tall unit can be reduced in depth, without price surcharge up to 58 cm</p>											
	Da/From 115x65 (anta 45) a/to 130x65 (anta 60)	C2A130N	3.121	3.137	3.180	3.193	3.387	3.282	3.509	-	-

COLONNE FRIGORIFERO
TALL UNITS FOR REFRIGERATOR

Prof. Depth **65**

Altezza Height **212**

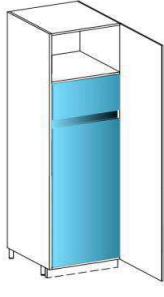
• I prezzi NON comprendono maniglie, gole e zoccolo • Prices do NOT included the handles, the groove and the plinth

Elemento Unit	Larghezza Width	Codice Code	1	2	3	4	5	6	7	8	9
 <p>• COLONNA 1 ANTA PER FRIGORIFERO/CONGELATORE</p> <p>◇ L'anta sarà vincolata al frigo oppure alla colonna, in base al tipo di elettrodomestico che verrà inserito</p> <p>◇ La colonna si può ridurre in profondità, senza maggiorazioni di prezzo fino a 58cm</p>											
 <p>• TALL UNIT 1 DOOR FOR REFRIGERATOR AND FREEZER</p> <p>◇ The door to the refrigerator or be bound to the column, according to type of appliance that will be inserted</p> <p>◇ The tall unit can be reduced in depth, without price surcharge up to 58cm</p>											
	Da/From 260Lt. 290Lt. 330Lt.	C2FR060A	1.047	1.080	1.100	1.120	1.307	1.146	1.304	-	-

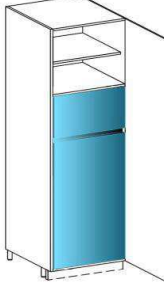
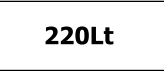
 <p>• COLONNA 1 ANTA PER FRIGORIFERO/CONGELATORE Con un ripiano interno regolabile</p> <p>◇ L'anta sarà vincolata al frigo oppure alla colonna, in base al tipo di elettrodomestico che verrà inserito</p> <p>◇ La colonna si può ridurre in profondità, senza maggiorazioni di prezzo fino a 58cm</p>											
 <p>• TALL UNIT 1 DOOR FOR REFRIGERATOR AND FREEZER With one adjustable shelf</p> <p>◇ The door to the refrigerator or be bound to the column, according to type of appliance that will be inserted</p> <p>◇ The tall unit can be reduced in depth, without price surcharge up to 58cm</p>											
	Da/From 220Lt. 240Lt.	C2FR060B	1.133	1.162	1.185	1.202	1.393	1.232	1.390	-	-

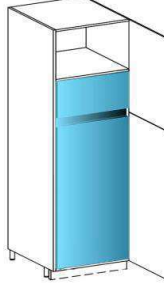
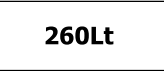
 <p>• COLONNA 2 ANTE PER FRIGORIFERO/CONGELATORE</p> <p>◇ L'anta sarà vincolata al frigo oppure alla colonna, in base al tipo di elettrodomestico che verrà inserito</p> <p>◇ La colonna si può ridurre in profondità, senza maggiorazioni di prezzo fino a 58cm</p>											
 <p>• TALL UNIT 2 DOORS FOR REFRIGERATOR AND FREEZER</p> <p>◇ The door to the refrigerator or be bound to the column, according to type of appliance that will be inserted</p> <p>◇ The tall unit can be reduced in depth, without price surcharge up to 58cm</p>											
	Da/From 260Lt. 290Lt.	C2FR060C	1.126	1.159	1.182	1.199	1.386	1.297	1.524	-	-

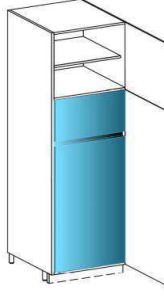
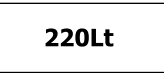

 <p>• COLONNA 2 ANTE PER FRIGORIFERO/CONGELATORE Con un ripiano interno regolabile</p> <p>◇ L'anta sarà vincolata al frigo oppure alla colonna, in base al tipo di elettrodomestico che verrà inserito</p> <p>◇ La colonna si può ridurre in profondità, senza maggiorazioni di prezzo fino a 58cm</p>											
 <p>• TALL UNIT 2 DOORS FOR REFRIGERATOR AND FREEZER With one adjustable shelf</p> <p>◇ The door to the refrigerator or be bound to the column, according to type of appliance that will be inserted</p> <p>◇ The tall unit can be reduced in depth, without price surcharge up to 58cm</p>											
	Da/From 220Lt. 240Lt.	C2FR060D	1.202	1.232	1.255	1.271	1.462	1.370	1.600	-	-



COLONNE FRIGORIFERO
TALL UNITS FOR REFRIGERATOR

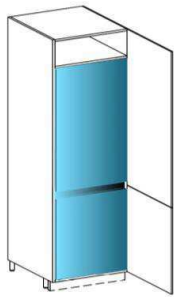

Prof. Depth **65**

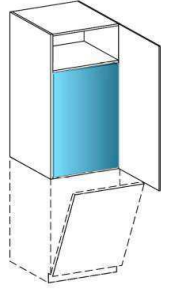

Altezza Height **212**

• I prezzi NON comprendono maniglie, gole e zoccolo • Prices do NOT included the handles, the groove and the plinth

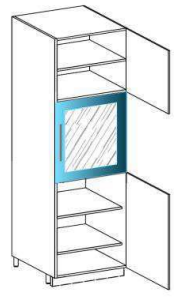
Elemento Unit	Larghezza Width	Codice Code	1	2	3	4	5	6	7	8	9
		COLONNA 2 ANTE PER FRIGORIFERO/CONGELATORE	<ul style="list-style-type: none"> L'anta sarà vincolata al frigo oppure alla colonna, in base al tipo di elettrodomestico che verrà inserito La colonna si può ridurre in profondità, senza maggiorazioni di prezzo fino a 58cm 								
			TALL UNIT 2 DOORS FOR REFRIGERATOR AND FREEZER	<ul style="list-style-type: none"> The door to the refrigerator or be bound to the column, according to type of appliance that will be inserted The tall unit can be reduced in depth, without price surcharge up to 58cm 							
 280Lt	Largh./Width 60	C2FR060E		1.116	1.146	1.169	1.185	1.376	1.284	1.515	-

		COLONNA 1 ANTA SOPRA LAVASTOVIGLIE PER FRIGORIFERO	<ul style="list-style-type: none"> L'anta sarà vincolata al frigo oppure alla colonna, in base al tipo di elettrodomestico che verrà inserito La colonna si può ridurre in profondità, senza maggiorazioni di prezzo fino a 58cm 								
			TALL UNIT WITH DOOR ABOVE A DISHWASHER FOR REFRIGERATOR	<ul style="list-style-type: none"> The door to the refrigerator or be bound to the column, according to type of appliance that will be inserted The tall unit can be reduced in depth, without price surcharge up to 58cm 							
 130Lt. 147Lt. 172Lt.	Largh./Width 60	C2FR060H		771	787	804	817	922	846	972	-

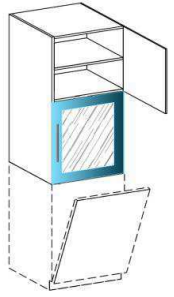
		COLONNA 2 ANTE CON VANO PER FRIGO CANTINA	<ul style="list-style-type: none"> Colonna adatta all'inserimento solo di frigo cantina specificatamente da incasso Con tre ripiani interni regolabili La colonna si può ridurre in profondità, senza maggiorazioni di prezzo fino a 58cm 								
			TALL UNIT 2 DOORS WITH HOUSING FOR FRIDGE WINE CELLAR	<ul style="list-style-type: none"> Suitable tall units to the inclusion of only wine cabinet specifically built With three internal adjustable shelves The tall unit can be reduced in depth, without price surcharge up to 58cm 							
 22÷46 Bottiglie	Largh./Width 60	C2CAN060		1.343	1.357	1.376	1.386	1.498	1.465	1.663	-



		COLONNA 1 ANTA SOPRA LAVASTOVIGLIE PER FRIGO CANTINA	<ul style="list-style-type: none"> Colonna adatta all'inserimento solo di frigo cantina specificatamente da incasso Con un ripiano interno regolabile La colonna si può ridurre in profondità, senza maggiorazioni di prezzo fino a 58cm 								
			TALL UNIT WITH DOOR ABOVE A DISHWASHER FOR FRIDGE WINE	<ul style="list-style-type: none"> Suitable tall units to the inclusion of only wine cabinet specifically built With one adjustable shelf The tall unit can be reduced in depth, without price surcharge up to 58cm 							
 22÷46 Bottiglie	Largh./Width 60	C2CAN060H		741	748	758	761	804	800	893	-



COLONNE FRIGORIFERO
TALL UNITS FOR REFRIGERATOR

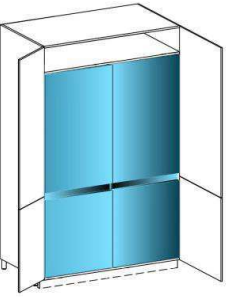

Prof. Depth **65**

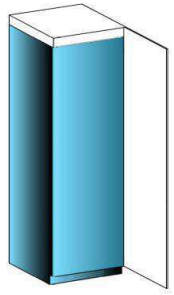

Altezza Height **212**

• I prezzi NON comprendono maniglie, gole e zoccolo • Prices do NOT included the handles, the groove and the plinth

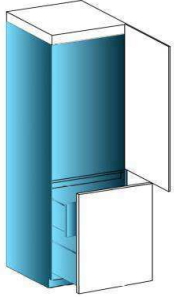
Elemento Unit	Larghezza Width	Codice Code	1	2	3	4	5	6	7	8	9
		STRUTTURA COLONNA CON 4 ANTE PER FRIGO REX QUATTROPORTE	<ul style="list-style-type: none"> Le quattro ante sono da fissare direttamente sulle porte dell'elettrodomestico La struttura si può ridurre in profondità, senza maggiorazioni di prezzo fino a 58cm 								
			TALL UNIT WITH 4 DOORS FOR REX QUATTROPORTE FRIDGE	<ul style="list-style-type: none"> The four doors are to be fixed directly onto the appliance door The tall unit can be reduced in depth, without price surcharge up to 58cm 							
 REX-ELECTROLUX Mod. QuattroPorte	Largh./Width 90	C2FR090A4		1.646	1.689	1.738	1.758	2.077	1.969	2.433	-

		1 ANTA + ELEMENTI STRUTTURALI PER FRIGORIFERO INTEGRATO	<ul style="list-style-type: none"> L'anta è da fissare direttamente sulla porta dell'elettrodomestico La struttura si può ridurre in profondità, senza maggiorazioni di prezzo fino a 58cm 								
			1 DOOR + STRUCTURAL ELEMENTS FOR INTEGRATED REFRIGERATOR	<ul style="list-style-type: none"> The door is to be fixed directly onto the appliance door The tall unit can be reduced in depth, without price surcharge up to 58cm 							
 FHIABA Serie Integrated	Largh./Width 60	A2FR060A1		906	935	958	975	1.166	1.074	1.304	-
	Largh./Width 75	A2FR075A1	1.008	1.050	1.074	1.097	1.337	1.192	1.429	-	-
	Largh./Width 90	A2FR090A1	1.106	1.162	1.185	1.218	1.508	1.307	1.554	-	-

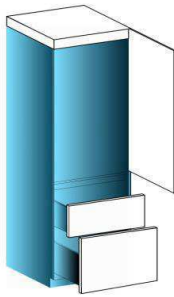
		2 ANTE + ELEMENTI STRUTTURALI PER FRIGORIFERO INTEGRATO	<ul style="list-style-type: none"> Le ante sono da fissare direttamente su porta e cassettoni dell'elettrodomestico La struttura si può ridurre in profondità, senza maggiorazioni di prezzo fino a 58cm 								
			2 DOORS + STRUCTURAL ELEMENTS FOR INTEGRATED REFRIGERATOR	<ul style="list-style-type: none"> The doors are to be fixed directly onto the appliance door and deep drawer The structure can be reduced in depth, without price surcharge up to 58cm 							
 FHIABA Serie Integrated	Largh./Width 60	A2FR060A2		919	948	972	988	1.176	1.087	1.317	-
	Largh./Width 75	A2FR075A2	1.018	1.060	1.087	1.110	1.350	1.205	1.442	-	-
	Largh./Width 90	A2FR090A2	1.120	1.176	1.199	1.232	1.521	1.320	1.567	-	-



		3 ANTE + ELEMENTI STRUTTURALI PER FRIGORIFERO INTEGRATO	<ul style="list-style-type: none"> Le ante sono da fissare direttamente su porta e cassettoni dell'elettrodomestico La struttura si può ridurre in profondità, senza maggiorazioni di prezzo fino a 58cm 								
			3 DOORS + STRUCTURAL ELEMENTS FOR INTEGRATED REFRIGERATOR	<ul style="list-style-type: none"> The doors are to be fixed directly onto the appliance door and deep drawer The structure can be reduced in depth, without price surcharge up to 58cm 							
 FHIABA Serie Integrated	Largh./Width 60	A2FR060A3		978	1.008	1.031	1.047	1.235	929	1.518	-
	Largh./Width 75	A2FR075A3	1.077	1.120	1.146	1.169	1.409	1.001	1.653	-	-
	Largh./Width 90	A2FR090A3	1.179	1.235	1.258	1.291	1.580	1.465	1.788	-	-

COLONNE FORNO
TALL UNITS FOR OVEN

Prof. Depth **65**

Altezza Height **212**

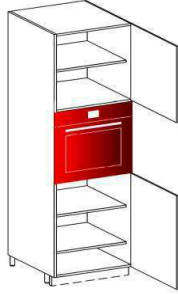
• I prezzi NON comprendono maniglie, gole e zoccolo • Prices do NOT included the handles, the groove and the plinth

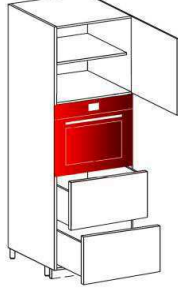
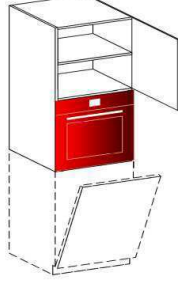

Elemento Unit	Larghezza Width	Codice Code	1	2	3	4	5	6	7	8	9
 <p>• COLONNA 2 ANTE CON VANO PER FORNO Con tre ripiani interni regolabili</p> <p>◇ La struttura si può ridurre in profondità, senza maggiorazioni di prezzo fino a 58cm</p>	Largh./Width 60	C2F060A2	1.363	1.380	1.399	1.409	1.531	1.488	1.689	-	-
			<p>• TALL UNIT 2 DOORS WITH HOUSING FOR OVEN With three internal adjustable shelves</p> <p>◇ The structure can be reduced in depth, without price surcharge up to 58cm</p>								
 <p>• COLONNA 1 ANTA + 1 CASSETTONE + CASSETTO INTERNO PER FORNO Con ripiano interno regolabile</p> <p>◇ La struttura si può ridurre in profondità, senza maggiorazioni di prezzo fino a 58cm</p>	Largh./Width 60	C2F060E1	1.702	1.715	1.738	1.748	1.870	1.824	2.028	-	-
			<p>• TALL UNIT 1 DOOR + DEEP DRAWER + INTERNAL DRAWER FOR OVEN With internal adjustable shelf</p> <p>◇ The structure can be reduced in depth, without price surcharge up to 58cm</p>								
 <p>• COLONNA 1 ANTA + 2 CASSETTONI PER FORNO Con ripiano interno regolabile</p> <p>◇ La struttura si può ridurre in profondità, senza maggiorazioni di prezzo fino a 58cm</p>	Largh./Width 60	C2F060C2	1.673	1.689	1.712	1.722	1.840	1.870	2.143	-	-
			<p>• TALL UNIT 1 DOOR + 2 DEEP DRAWERS FOR OVEN With internal adjustable shelf</p> <p>◇ The structure can be reduced in depth, without price surcharge up to 58cm</p>								
 <p>• COLONNA 1 ANTA SOPRA LAVASTOVIGLIE PER FORNO Con un ripiano interno regolabile</p> <p>◇ La struttura si può ridurre in profondità, senza maggiorazioni di prezzo fino a 58cm</p>	Largh./Width 60	C2F060H	764	771	781	784	837	823	919	-	-
			<p>• TALL UNIT WITH DOOR ABOVE A DISHWASHER FOR OVEN With one adjustable shelf</p> <p>◇ The structure can be reduced in depth, without price surcharge up to 58cm</p>								

COLONNE FORNO
TALL UNITS FOR OVEN

Prof. Depth **65**

Altezza Height **212**

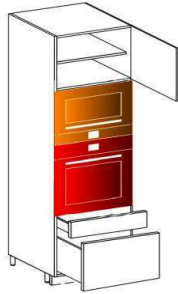
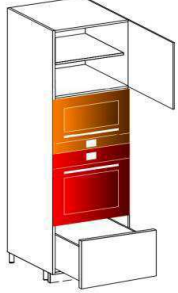
• I prezzi NON comprendono maniglie, gole e zoccolo • Prices do NOT included the handles, the groove and the plinth

Elemento Unit	Larghezza Width	Codice Code	1	2	3	4	5	6	7	8	9
 <p>• COLONNA 1 ANTA + 1 CASSETTO + 1 CASSETTONE PER FORNI Con ripiano interno regolabile</p> <p>◇ La struttura si può ridurre in profondità, senza maggiorazioni di prezzo fino a 58cm</p>	Largh./Width 60	C2FM060C2	1.561	1.567	1.587	1.594	1.669	1.702	1.877	-	-
			<p>• TALL UNIT 1 DOOR + 1 DRAWER + 1 DEPP DRAWERS FOR OVENS With internal adjustable shelf</p> <p>◇ The structure can be reduced in depth, without price surcharge up to 58cm</p>								
 <p>• COLONNA 1 ANTA + 1 CASSETTONE PER FORNI Con ripiano interno regolabile</p> <p>◇ La struttura si può ridurre in profondità, senza maggiorazioni di prezzo fino a 58cm</p>	Largh./Width 60	C2FM060CA	1.386	1.393	1.413	1.419	1.495	1.498	1.679	-	-
			<p>• TALL UNIT 1 DOOR + 1 DEPP DRAWERS FOR OVENS With internal adjustable shelf</p> <p>◇ The structure can be reduced in depth, without price surcharge up to 58cm</p>								
 <p>• COLONNA 1 ANTA + 1 CASSETTONE PER FORNI Con ripiano interno regolabile</p> <p>◇ La struttura si può ridurre in profondità, senza maggiorazioni di prezzo fino a 58cm</p>	Largh./Width 60	C2FM060CB	1.337	1.347	1.363	1.373	1.445	1.449	1.633	-	-
			<p>• TALL UNIT 1 DOOR + 1 DEPP DRAWERS FOR OVENS With internal adjustable shelf</p> <p>◇ The structure can be reduced in depth, without price surcharge up to 58cm</p>								

COLONNE DISPENSA
TALL LARDER UNITS

Prof. **65** Altezza **227+242**
Depth Height

• I prezzi NON comprendono maniglie, gole e zoccolo • Prices do NOT included the handles, the groove and the plinth

Elemento Unit	Larghezza Width	Codice Code	1	2	3	4	5	6	7	8	9
---------------	-----------------	-------------	---	---	---	---	---	---	---	---	---

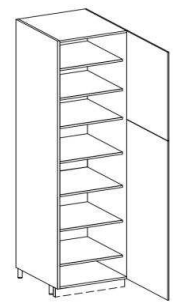

• **COLONNA 2 ANTE**

Con sei ripiani interni regolabili

◊ La colonna si può ridurre in profondità, senza maggiorazioni di prezzo fino a 35cm

• **TALL UNIT 2 DOORS**

With six internal adjustable shelves

◊ The tall unit can be reduced in depth, without price surcharge up to 35cm

Da/From 20 a/to 45	C4D045A2	1.505	1.528	1.551	1.564	1.722	1.666	1.900	-	-
Da/From 46 a/to 65	C4D065A2	1.758	1.794	1.821	1.840	2.058	1.936	2.179	-	-

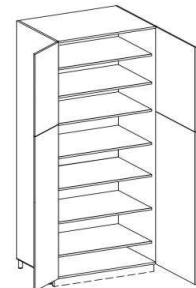

• **COLONNA 4 ANTE**

Con sei ripiani interni regolabili

◊ La colonna si può ridurre in profondità, senza maggiorazioni di prezzo fino a 35cm

• **TALL UNIT 4 DOORS**

With six internal adjustable shelves

◊ The tall unit can be reduced in depth, without price surcharge up to 35cm

Da/From 60 a/to 95	C4D095A4	2.446	2.489	2.538	2.558	2.877	2.765	3.233	-	-
Da/From 95 a/to 130	C4D130A4	2.969	3.042	3.091	3.127	3.565	3.325	3.809	-	-

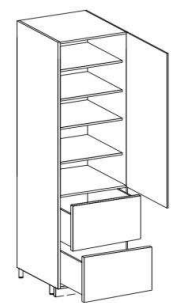

• **COLONNA 1 ANTA + 2 CASSETTONI**

Con quattro ripiani interni regolabili

◊ La colonna si può ridurre in profondità, senza maggiorazioni di prezzo fino a 35cm

• **TALL UNIT 1 DOOR + 2 DEEP DRAWERS**

With four internal adjustable shelves

◊ The tall unit can be reduced in depth, without price surcharge up to 35cm

Da/From 20 a/to 45	C4D045C2	1.814	1.837	1.860	1.870	2.031	2.038	2.337	-	-
Da/From 45 a/to 65	C4D065C2	2.071	2.107	2.130	2.150	2.367	2.318	2.630	-	-

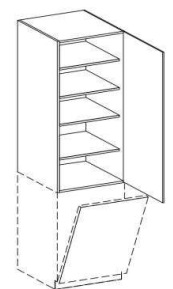

• **COLONNA 1 ANTA SOPRA LAVASTOVIGLIE**

Con quattro ripiani interni regolabili

◊ La colonna si può ridurre in profondità, senza maggiorazioni di prezzo fino a 58 cm

• **TALL UNIT WITH DOOR ABOVE A DISHWASHER**

With four internal adjustable shelves

◊ The tall unit can be reduced in depth, without price surcharge up to 58 cm

Da/From 20 a/to 45	C4D045H	1.001	1.014	1.034	1.041	1.139	1.320	1.623	-	-
Da/From 45 a/to 65	C4D065H	1.169	1.192	1.212	1.225	1.363	1.541	1.854	-	-



COLONNE DISPENSA
TALL LARDER UNITS

Prof. **65** Altezza **227+242**
Depth Height

• I prezzi NON comprendono maniglie, gole e zoccolo • Prices do NOT included the handles, the groove and the plinth

Elemento Unit	Larghezza Width	Codice Code	1	2	3	4	5	6	7	8	9
---------------	-----------------	-------------	---	---	---	---	---	---	---	---	---

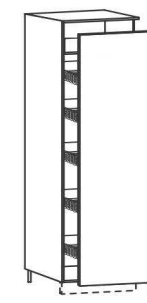

• **COLONNA 1 ANTA ESTRAIBILE**

Meccanismo estraibile attrezzato con cinque cestelli in finitura titanio regolabili in altezza

◊ La colonna si può ridurre in profondità, senza maggiorazioni di prezzo fino a 58cm

• **TALL UNIT 1 PULL-OUT DOOR**

Pull-out mechanism equipped with five basket titanium finish adjustable-height

◊ The tall unit can be reduced in depth, without price surcharge up to 58cm

Largh./Width 30	C4030E	1.666	1.673	1.696	1.699	1.798	1.811	2.035	-	-
Largh./Width 40	C4040E	1.781	1.798	1.821	1.831	1.969	1.936	2.166	-	-
Largh./Width 45	C4045E	1.844	1.867	1.893	1.903	2.061	2.005	2.239	-	-
Largh./Width 60	C4060E	2.041	2.077	2.104	2.124	2.341	2.219	2.463	-	-

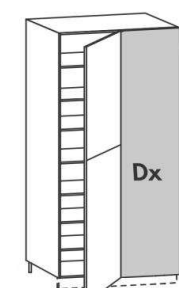

• **COLONNA ANGOLARE 2 ANTE**

Con sei ripiani interni regolabili

◊ La colonna si può ridurre in profondità, senza maggiorazioni di prezzo fino a 35cm

• **CORNER TALL UNIT 2 DOORS**

With seven internal adjustable shelves

◊ The tall unit can be reduced in depth, without price surcharge up to 35cm

Da/From 115x65 (anta 45) a/to 135x65 (anta 65)	C4A130B	2.887	2.907	2.956	2.969	3.197	3.055	3.299	-	-
---	----------------	-------	-------	-------	-------	-------	-------	-------	---	---

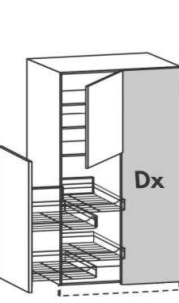

• **COLONNA ANGOLARE 2 ANTE**

Con 2 ripiani interni regolabili con meccanismo dotato di cesti estraibili a traino dell'anta

◊ La colonna si può ridurre in profondità, senza maggiorazioni di prezzo fino a 58 cm

• **CORNER TALL UNIT 2 DOORS**

With two internal adjustable shelves with mechanism equipped with removable baskets in tow wing

◊ The tall unit can be reduced in depth, without price surcharge up to 58 cm

Da/From 115x65 (anta 45) a/to 135x65 (anta 65)	C4A130CM	3.516	3.536	3.585	3.601	3.825	3.687	3.931	-	-
---	-----------------	-------	-------	-------	-------	-------	-------	-------	---	---

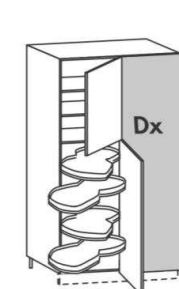

• **COLONNA ANGOLARE 2 ANTE**

Con 2 ripiani interni regolabili con due cestelli indipendenti, estraibili e girevoli

◊ La colonna si può ridurre in profondità, senza maggiorazioni di prezzo fino a 58 cm

• **CORNER TALL UNIT 2 DOORS**

With two internal adjustable shelves with two independent baskets, removable and rotatable

◊ The tall unit can be reduced in depth, without price surcharge up to 58 cm

Da/From 115x65 (anta 45) a/to 135x65 (anta 65)	C4A130N	3.223	3.243	3.292	3.305	3.532	3.394	3.634	-	-
---	----------------	-------	-------	-------	-------	-------	-------	-------	---	---



COLONNE FRIGORIFERO
TALL UNITS FOR REFRIGERATOR

Prof. **65** Altezza **227+242**
Depth Height

• I prezzi NON comprendono maniglie, gole e zoccolo • Prices do NOT included the handles, the groove and the plinth

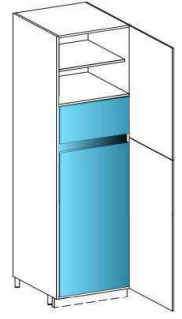
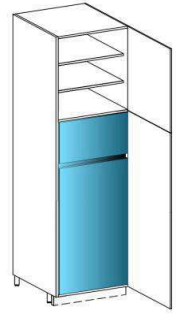
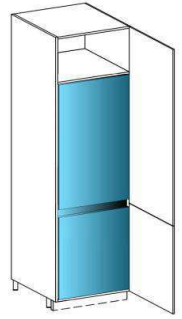
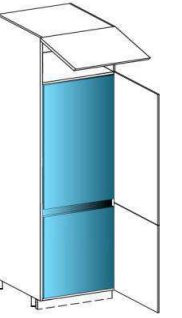
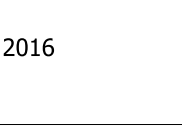
Elemento Unit	Larghezza Width	Codice Code	1	2	3	4	5	6	7	8	9
 <ul style="list-style-type: none"> COLONNA 2 ANTE PER FRIGORIFERO/CONGELATORE Con un ripiano interno regolabile ◊ L'anta sarà vincolata al frigo oppure alla colonna, in base al tipo di elettrodomestico che verrà inserito ◊ La colonna si può ridurre in profondità, senza maggiorazioni di prezzo fino a 58cm 	Largh./Width 60	C4FR060A	1.311	1.347	1.373	1.390	1.610	1.492	1.732	-	-
			260Lt 290Lt								
 <ul style="list-style-type: none"> TALL UNIT 2 DOORS FOR REFRIGERATOR AND FREEZER With one adjustable shelf ◊ The door to the refrigerator or be bound to the column, according to type of appliance that will be inserted ◊ The tall unit can be reduced in depth, without price surcharge up to 58cm 	Largh./Width 60	C4FR060B	1.413	1.449	1.475	1.495	1.712	1.590	1.834	-	-
			220Lt 240Lt								
 <ul style="list-style-type: none"> COLONNA 2 ANTE PER FRIGORIFERO/CONGELATORE ◊ L'anta sarà vincolata al frigo oppure alla colonna, in base al tipo di elettrodomestico che verrà inserito ◊ La colonna si può ridurre in profondità, senza maggiorazioni di prezzo fino a 58cm 	Largh./Width 60	C4FR060C	1.232	1.268	1.294	1.311	1.531	1.409	1.650	-	-
			280Lt 330Lt								
 <ul style="list-style-type: none"> TALL UNIT 2 DOORS FOR REFRIGERATOR AND FREEZER With four internal adjustable shelves ◊ The door to the refrigerator or be bound to the column, according to type of appliance that will be inserted ◊ The tall unit can be reduced in depth, without price surcharge up to 58cm 	Largh./Width 60	C4FR060D	1.363	1.399	1.422	1.442	1.659	1.610	1.923	-	-
			280Lt 330Lt								
 <ul style="list-style-type: none"> COLONNA 2 ANTE + ANTA RIBALTA HK PER FRIGORIFERO/ CONGELATORE ◊ L'anta sarà vincolata al frigo oppure alla colonna, in base al tipo di elettrodomestico che verrà inserito ◊ La colonna si può ridurre in profondità, senza maggiorazioni di prezzo fino a 58cm 	Largh./Width 60	C4FR060D	1.363	1.399	1.422	1.442	1.659	1.610	1.923	-	-
			280Lt 330Lt								

COLONNE FRIGORIFERO
TALL UNITS FOR REFRIGERATOR

Prof. **65** Altezza **227+242**
Depth Height

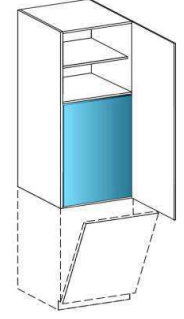
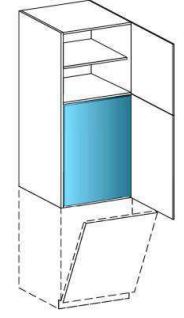
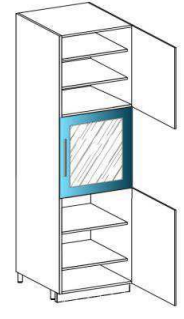
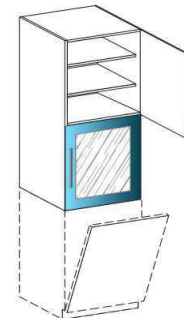
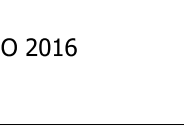

• I prezzi NON comprendono maniglie, gole e zoccolo • Prices do NOT included the handles, the groove and the plinth



Elemento Unit	Larghezza Width	Codice Code	1	2	3	4	5	6	7	8	9
 <ul style="list-style-type: none"> COLONNA 1 ANTA SOPRA LAVASTOVIGLIE PER FRIGORIFERO Con zero/un ripiano interno regolabile ◊ L'anta sarà vincolata al frigo oppure alla colonna, in base al tipo di elettrodomestico che verrà inserito ◊ La colonna si può ridurre in profondità, senza maggiorazioni di prezzo fino a 58cm 	Largh./Width 60	C4FR060H1	932	955	972	988	1.123	1.232	1.472	-	-
			130Lt. 147Lt. 172Lt.								
 <ul style="list-style-type: none"> TALL UNIT WITH DOOR ABOVE A DISHWASHER FOR REFRIGERATOR ◊ The door to the refrigerator or be bound to the column, according to type of appliance that will be inserted ◊ The tall unit can be reduced in depth, without price surcharge up to 58cm 	Largh./Width 60	C4FR060H2	958	981	998	1.014	1.149	1.113	1.317	-	-
			130Lt. 147Lt. 172Lt.								
 <ul style="list-style-type: none"> COLONNA 2 ANTE SOPRA LAVASTOVIGLIE PER FRIGORIFERO Con zero/un ripiano interno regolabile ◊ L'anta sarà vincolata al frigo oppure alla colonna, in base al tipo di elettrodomestico che verrà inserito ◊ La colonna si può ridurre in profondità, senza maggiorazioni di prezzo fino a 58cm 	Largh./Width 60	C4CAN060	1.548	1.564	1.587	1.600	1.738	1.676	1.887	-	-
			22÷46 Bottiglie								
 <ul style="list-style-type: none"> TALL UNIT 2 DOORS WITH HOUSING FOR FRIDGE WINE CELLAR With four internal adjustable shelves ◊ Suitable tall units to the inclusion of only wine cabinet specifically built ◊ The tall unit can be reduced in depth, without price surcharge up to 58cm 	Largh./Width 60	C4CAN060H	899	909	919	925	995	962	1.067	-	-
			22÷46 Bottiglie								
 <ul style="list-style-type: none"> COLONNA 2 ANTE CON VANO PER FRIGO CANTINA Con quattro ripiani interni regolabili ◊ Colonna adatta all'inserimento solo di frigo cantina specificatamente da incasso ◊ La colonna si può ridurre in profondità, senza maggiorazioni di prezzo fino a 58cm 	Largh./Width 60	C4CAN060H	899	909	919	925	995	962	1.067	-	-
			22÷46 Bottiglie								
<ul style="list-style-type: none"> TALL UNIT 2 DOORS WITH HOUSING FOR FRIDGE WINE CELLAR With two adjustable shelves ◊ Suitable tall units to the inclusion of only wine cabinet specifically built ◊ The tall unit can be reduced in depth, without price surcharge up to 58cm 	Largh./Width 60	C4CAN060H	899	909	919	925	995	962	1.067	-	-
			22÷46 Bottiglie								

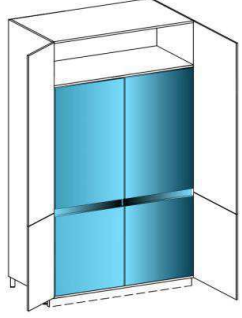

COLONNE FRIGORIFERO
TALL UNITS FOR REFRIGERATOR

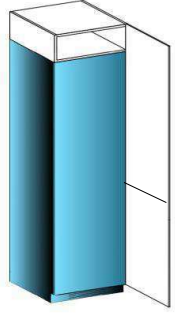

Prof. **65** Altezza **227+242**
Depth Height

• I prezzi NON comprendono maniglie, gole e zoccolo • Prices do NOT included the handles, the groove and the plinth

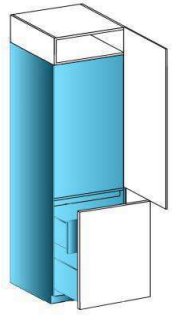
Elemento Unit	Larghezza Width	Codice Code	1	2	3	4	5	6	7	8	9
 <p>• STRUTTURA COLONNA CON 4 ANTE PER FRIGO REX QUATTROPORTE Fornita smontata e predisposta con giunzioni</p> <p>• TALL UNIT WITH 4 DOORS FOR REX QUATTROPORTE FRIDGE Supplied disassembled and predisposed with</p>	Largh./Width 90	C4FR090A4	<p>◊ Le quattro ante sono da fissare direttamente sulle porte dell'elettrodomestico ◊ La struttura si può ridurre in profondità, senza maggiorazioni di prezzo fino a 58cm</p> <p>◊ The four doors are to be fixed directly onto the appliance door ◊ The tall unit can be reduced in depth, without price surcharge up to 58cm</p>								
			1.758	1.801	1.850	1.870	2.189	2.081	2.545	-	-
 <p>REX-ELECTROLUX Mod. QuattroPorte</p>											

 <p>• 1 ANTA + ELEMENTI STRUTTURALI PER FRIGORIFERO INTEGRATO</p> <p>• 1 DOOR + STRUCTURAL ELEMENTS FOR INTEGRATED REFRIGERATOR</p>	Largh./Width 60	A4FR060A1	<p>◊ L'anta è da fissare direttamente sulla porta dell'elettrodomestico ◊ La struttura si può ridurre in profondità, senza maggiorazioni di prezzo fino a 58cm</p> <p>◊ The door is to be fixed directly onto the appliance door ◊ The tall unit can be reduced in depth, without price surcharge up to 58cm</p>								
			1.001	1.037	1.064	1.083	1.301	1.179	1.422	-	-
 <p>FHIABA Serie Integrated</p>	Largh./Width 75	A4FR075A1	1.113	1.162	1.192	1.218	1.495	1.307	1.561	-	-
	Largh./Width 90	A4FR090A1	1.518	1.584	1.610	1.646	1.982	1.729	1.989	-	-

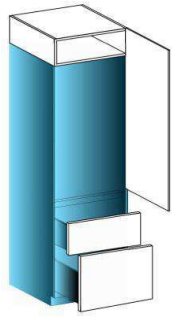

 <p>• 2 ANTE + ELEMENTI STRUTTURALI PER FRIGORIFERO INTEGRATO</p> <p>• 2 DOORS + STRUCTURAL ELEMENTS FOR INTEGRATED REFRIGERATOR</p>	Largh./Width 60	A4FR060A2	<p>◊ Le ante sono da fissare direttamente su porta e cassetto dell'elettrodomestico ◊ La struttura si può ridurre in profondità, senza maggiorazioni di prezzo fino a 58cm</p> <p>◊ The doors are to be fixed directly onto the appliance door and deep drawer ◊ The structure can be reduced in depth, without price surcharge up to 58cm</p>								
			1.014	1.050	1.077	1.097	1.314	1.192	1.436	-	-
 <p>FHIABA Serie Integrated</p>	Largh./Width 75	A4FR075A2	1.126	1.176	1.202	1.232	1.508	1.320	1.571	-	-
	Largh./Width 90	A4FR090A2	1.241	1.304	1.334	1.366	1.702	1.452	1.712	-	-



 <p>• 3 ANTE + ELEMENTI STRUTTURALI PER FRIGORIFERO INTEGRATO</p> <p>• 2 DOORS + STRUCTURAL ELEMENTS FOR INTEGRATED REFRIGERATOR</p>	Largh./Width 60	A4FR060A3	<p>◊ Le ante sono da fissare direttamente su porta e cassetto dell'elettrodomestico ◊ La struttura si può ridurre in profondità, senza maggiorazioni di prezzo fino a 58cm</p> <p>◊ The doors are to be fixed directly onto the appliance door and deep drawer ◊ The structure can be reduced in depth, without price surcharge up to 58cm</p>								
			1.074	1.110	1.136	1.156	1.373	1.324	1.636	-	-
 <p>FHIABA Serie Integrated</p>	Largh./Width 75	A4FR075A3	1.185	1.235	1.261	1.291	1.567	1.459	1.781	-	-
	Largh./Width 90	A4FR090A3	1.301	1.363	1.393	1.426	1.761	1.597	1.933	-	-

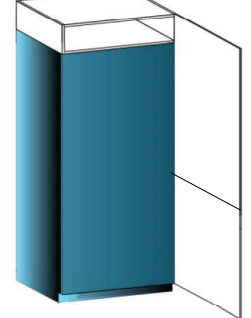

COLONNE FRIGORIFERO
TALL UNITS FOR REFRIGERATOR

Prof. **65** Altezza **227+242**
Depth Height

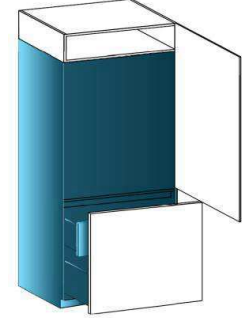
• I prezzi NON comprendono maniglie, gole e zoccolo • Prices do NOT included the handles, the groove and the plinth

Elemento Unit	Larghezza Width	Codice Code	1	2	3	4	5	6	7	8	9
 <p>• 1 ANTA + ELEMENTI STRUTTURALI PER FRIGORIFERO INTEGRATO</p> <p>• 1 DOOR + STRUCTURAL ELEMENTS FOR INTEGRATED REFRIGERATOR</p>	Largh./Width 45,7	A4FR046A1	<p>◊ L'anta è da fissare direttamente sulla porta dell'elettrodomestico ◊ La struttura si può ridurre in profondità, senza maggiorazioni di prezzo fino a 58cm</p> <p>◊ The door is to be fixed directly onto the appliance door ◊ The tall unit can be reduced in depth, without price surcharge up to 58cm</p>								
			856	876	902	912	1.070	1.018	1.248	-	-
 <p>GAGGENAU - SIEMENS MIELE</p>	Largh./Width 61	A4FR061A1	965	1.001	1.027	1.047	1.264	1.143	1.386	-	-
	Largh./Width 76,5	A4FR077A1	1.074	1.126	1.153	1.179	1.455	1.268	1.521	-	-
	Largh./Width 91,8	A4FR092A1	1.185	1.251	1.278	1.314	1.650	1.396	1.656	-	-

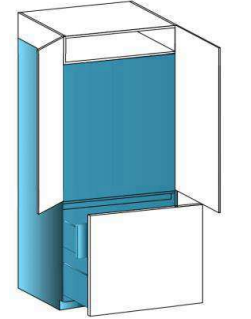
 <p>• 2 ANTE + ELEMENTI STRUTTURALI PER FRIGORIFERO INTEGRATO</p> <p>• 2 DOORS + STRUCTURAL ELEMENTS FOR INTEGRATED REFRIGERATOR</p>	Largh./Width 45,7	A4FR046A2	<p>◊ Le ante sono da fissare direttamente su porta e cassetto dell'elettrodomestico ◊ La struttura si può ridurre in profondità, senza maggiorazioni di prezzo fino a 58cm</p> <p>◊ The doors are to be fixed directly onto the appliance door and deep drawer ◊ The structure can be reduced in depth, without price surcharge up to 58cm</p>								
			866	889	912	925	1.083	1.027	1.261	-	-
 <p>GAGGENAU - SIEMENS MIELE</p>	Largh./Width 61	A4FR061A2	978	1.014	1.041	1.060	1.278	1.156	1.399	-	-
	Largh./Width 76,5	A4FR077A2	1.087	1.136	1.166	1.192	1.469	1.281	1.534	-	-
	Largh./Width 91,8	A4FR092A2	1.199	1.261	1.291	1.327	1.663	1.409	1.669	-	-

 <p>• 3 ANTE + ELEMENTI STRUTTURALI PER FRIGORIFERO INTEGRATO</p> <p>• 3 DOORS + STRUCTURAL ELEMENTS FOR INTEGRATED REFRIGERATOR</p>	Largh./Width 91,8	A4FR092A3	<p>◊ Le ante sono da fissare direttamente su porta e cassetto dell'elettrodomestico ◊ La struttura si può ridurre in profondità, senza maggiorazioni di prezzo fino a 58cm</p> <p>◊ The doors are to be fixed directly onto the appliance door and deep drawer ◊ The structure can be reduced in depth, without price surcharge up to 58cm</p>								
			1.258	1.320	1.350	1.386	1.722	1.564	1.943	-	-
 <p>GAGGENAU - SIEMENS MIELE</p>											

COLONNE FORNO
TALL UNITS FOR OVEN

Prof. Depth **65** Altezza Height **227+242**

• I prezzi NON comprendono maniglie, gole e zoccolo • Prices do NOT included the handles, the groove and the plinth

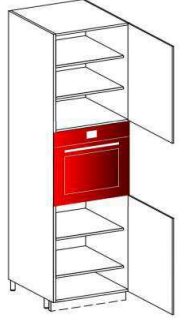
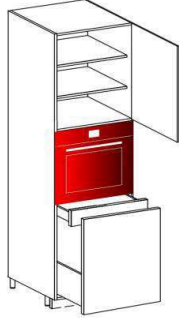
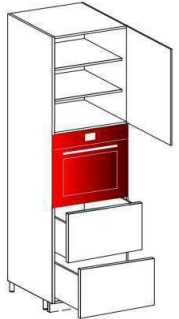
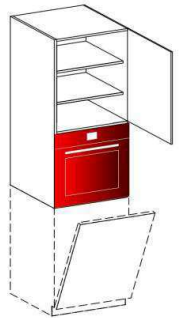
Elemento Unit	Larghezza Width	Codice Code	1	2	3	4	5	6	7	8	9
 <p>• COLONNA 2 ANTE CON VANO PER FORNO Con quattro ripiani interni regolabili ◊ La struttura si può ridurre in profondità, senza maggiorazioni di prezzo fino a 58cm</p> <p>• TALL UNIT 2 DOORS WITH HOUSING FOR OVEN With four internal adjustable shelves ◊ The structure can be reduced in depth, without price surcharge up to 58cm</p>	Largh./Width 60	C4F060A2	1.571	1.594	1.617	1.627	1.778	1.706	1.919	-	-
 <p>• COLONNA 1 ANTA + 1 CASSETTONE + CASSETTO INTERNO PER FORNO Con due ripiani interni regolabili ◊ La struttura si può ridurre in profondità, senza maggiorazioni di prezzo fino a 58cm</p> <p>• TALL UNIT 1 DOOR + DEEP DRAWER + INTERNAL DRAWER FOR OVEN With two internal adjustable shelves ◊ The structure can be reduced in depth, without price surcharge up to 58cm</p>	Largh./Width 60	C4F060E1	1.857	1.821	1.847	1.857	2.008	1.933	2.150	-	-
 <p>• COLONNA 1 ANTA + 2 CASSETTONI PER FORNO Con due ripiani interni regolabili ◊ La struttura si può ridurre in profondità, senza maggiorazioni di prezzo fino a 58cm</p> <p>• TALL UNIT 1 DOOR + 2 DEEP DRAWERS FOR OVEN With two internal adjustable shelves ◊ The structure can be reduced in depth, without price surcharge up to 58cm</p>	Largh./Width 60	C4F060C2	1.883	1.903	1.929	1.939	2.091	2.087	2.374	-	-
 <p>• COLONNA 1 ANTA SOPRA LAVASTOVIGLIE PER FORNO Con due ripiani interni regolabili ◊ La struttura si può ridurre in profondità, senza maggiorazioni di prezzo fino a 58cm</p> <p>• TALL UNIT WITH DOOR ABOVE A DISHWASHER FOR OVEN With two internal adjustable shelves ◊ The structure can be reduced in depth, without price surcharge up to 58cm</p>	Largh./Width 60	C4F060H	942	955	968	972	1.054	1.011	1.120	-	-

COLONNE FORNO
TALL UNITS FOR OVEN

Prof. Depth **65** Altezza Height **227+242**

• I prezzi NON comprendono maniglie, gole e zoccolo • Prices do NOT included the handles, the groove and the plinth

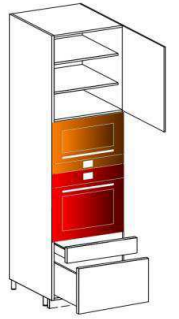
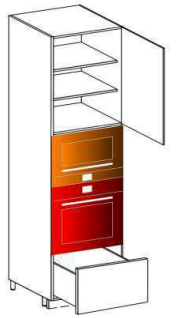
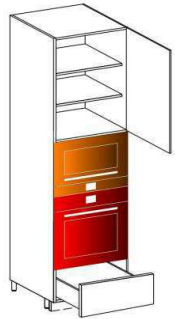
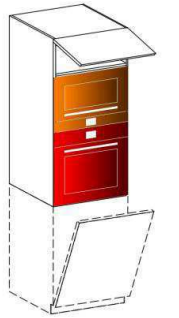
Elemento Unit	Larghezza Width	Codice Code	1	2	3	4	5	6	7	8	9
 <p>• COLONNA 1 ANTA + 1 CASSETTO + 1 CASSETTONE PER FORNI Con due ripiani interni regolabili ◊ La struttura si può ridurre in profondità, senza maggiorazioni di prezzo fino a 58cm</p> <p>• TALL UNIT 1 DOOR + 1 DRAWER + 1 DEPP DRAWERS FOR OVENS With two internal adjustable shelves ◊ The structure can be reduced in depth, without price surcharge up to 58cm</p>	Largh./Width 60	C4FM060C2	1.768	1.781	1.801	1.811	1.916	1.919	2.107	-	-
 <p>• COLONNA 1 ANTA + 1 CASSETTONE PER FORNI Con due ripiani interni regolabili ◊ La struttura si può ridurre in profondità, senza maggiorazioni di prezzo fino a 58cm</p> <p>• TALL UNIT 1 DOOR + 1 DEPP DRAWERS FOR OVENS With two internal adjustable shelves ◊ The structure can be reduced in depth, without price surcharge up to 58cm</p>	Largh./Width 60	C4FM060CA	1.594	1.607	1.627	1.636	1.742	1.715	1.910	-	-
 <p>• COLONNA 1 ANTA + 1 CASSETTONE PER FORNI Con due ripiani interni regolabili ◊ La struttura si può ridurre in profondità, senza maggiorazioni di prezzo fino a 58cm</p> <p>• TALL UNIT 1 DOOR + 1 DEPP DRAWERS FOR OVENS With two internal adjustable shelves ◊ The structure can be reduced in depth, without price surcharge up to 58cm</p>	Largh./Width 60	C4FM060CB	1.551	1.564	1.584	1.597	1.699	1.669	1.867	-	-
 <p>• COLONNA 1 ANTA RIBALTA HK SOPRA LAVASTOVIGLIE PER FORNI ◊ La struttura si può ridurre in profondità, senza maggiorazioni di prezzo fino a 58cm</p> <p>• TALL UNIT WITH FLAP DOOR HK ABOVE A DISHWASHER FOR OVENS ◊ The structure can be reduced in depth, without price surcharge up to 58cm</p>	Largh./Width 60	C4FM060H	843	850	856	863	896	899	991	-	-

SOPRACOLONNE DISPENSA
OVER COLUMNS FOR LARDER

Prof. **65** Altezza **30/45/60**
Depth Height

• I prezzi NON comprendono maniglie, gole e zoccolo • Prices do NOT included the handles, the groove and the plinth

Elemento Unit	Larghezza Width	Codice Code	1	2	3	4	5	6	7	8	9
---------------	-----------------	-------------	---	---	---	---	---	---	---	---	---

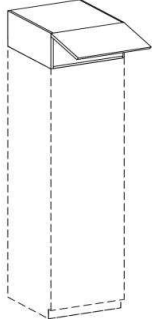
	• SOPRACOLONNA H.30 1 ANTA RIBALTA HK Ribalta con chiusura ammortizzata		◇ La colonna si può ridurre in profondità, senza maggiorazioni di prezzo fino a 35cm								
	• OVER COLUM H.30 1 DOOR FLAP HK Flap door with soft closure		◇ The tall unit can be reduced in depth, without price surcharge up to 35cm								
	Da/From 20 a/to 45	S1045R	412	412	419	422	432	458	537	-	-
	Da/From 46 a/to 65	S1065R	455	455	461	465	481	504	586	-	-
Da/From 66 a/to 95	S1095R	537	537	547	550	583	596	688	-	-	
Da/From 96 a/to 130	S1130R	619	623	636	636	685	692	790	-	-	

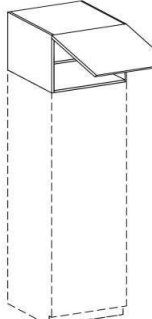
	• SOPRACOLONNA H.45 1 ANTA RIBALTA HK Ribalta con chiusura ammortizzata		◇ La colonna si può ridurre in profondità, senza maggiorazioni di prezzo fino a 35cm								
	• OVER COLUM H.45 1 DOOR FLAP HK Flap door with soft closure		◇ The tall unit can be reduced in depth, without price surcharge up to 35cm								
	Da/From 20 a/to 45	S2045R	553	557	563	567	586	603	688	-	-
	Da/From 46 a/to 65	S2065R	619	623	629	636	665	672	764	-	-
Da/From 66 a/to 95	S2095R	744	751	764	767	823	810	909	-	-	
Da/From 96 a/to 130	S2130R	876	886	899	906	985	955	1.060	-	-	

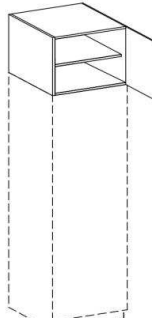
	• SOPRACOLONNA H.45 - 1 ANTA Con un ripiano interno regolabile		◇ La colonna si può ridurre in profondità, senza maggiorazioni di prezzo fino a 35cm								
	• OVER COLUM H.45 - 1 DOOR With a internal adjustabl shelf		◇ The tall unit can be reduced in depth, without price surcharge up to 35cm								
	Da/From 20 a/to 45	S2045	422	425	432	435	455	471	557	-	-
	Da/From 46 a/to 65	S2065	488	491	498	504	534	540	632	-	-

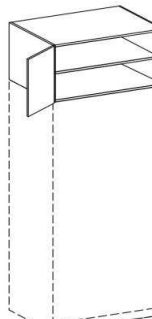
	• SOPRACOLONNA H.45 - 2 ANTE Con un ripiano interno regolabile		◇ La colonna si può ridurre in profondità, senza maggiorazioni di prezzo fino a 35cm								
	• OVER COLUM H.45 - 2 DOORS With a internal adjustabl shelf		◇ The tall unit can be reduced in depth, without price surcharge up to 35cm								
	Da/From 66 a/to 95	S2095	679	682	695	705	744	777	948	-	-
	Da/From 96 a/to 130	S2130	810	817	833	843	906	919	1.097	-	-

SOPRACOLONNE DISPENSA
OVER COLUMNS FOR LARDER

Prof. **65** Altezza **30/45/60**
Depth Height

• I prezzi NON comprendono maniglie, gole e zoccolo • Prices do NOT included the handles, the groove and the plinth

Elemento Unit	Larghezza Width	Codice Code	1	2	3	4	5	6	7	8	9
---------------	-----------------	-------------	---	---	---	---	---	---	---	---	---

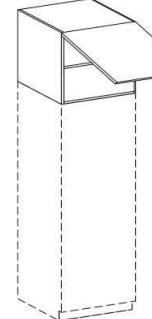
	• SOPRACOLONNA H.60 1 ANTA RIBALTA HK Ribalta con chiusura ammortizzata		◇ La colonna si può ridurre in profondità, senza maggiorazioni di prezzo fino a 35cm								
	• OVER COLUMNS H.30 1 FLAP DOOR HK Flap door with soft closure		◇ The tall unit can be reduced in depth, without price surcharge up to 58cm								
	Da/From 20 a/to 45	S3045R	609	613	619	623	656	662	754	-	-
	Da/From 46 a/to 65	S3065R	682	685	695	702	748	741	837	-	-
Da/From 66 a/to 95	S3095R	823	833	846	853	932	896	998	-	-	
Da/From 96 a/to 130	S3130R	972	988	1.001	1.008	1.120	1.054	1.166	-	-	

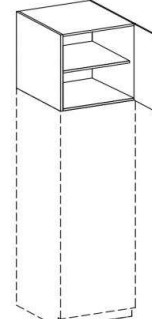
	• SOPRACOLONNA H.60 - 1 ANTA Con un ripiano interno regolabile		◇ La colonna si può ridurre in profondità, senza maggiorazioni di prezzo fino a 35cm								
	• TALL UNIT H.60 - 1 DOOR With a internal adjustabl shelf		◇ The tall unit can be reduced in depth, without price surcharge up to 35cm								
	Da/From 20 a/to 45	S3045	478	481	488	491	524	530	623	-	-
	Da/From 46 a/to 65	S3065	550	553	563	570	616	609	705	-	-

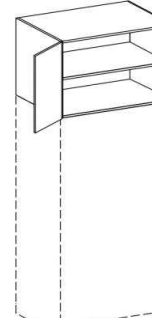
	• SOPRACOLONNA H.60 - 2 ANTE Con un ripiano interno regolabile		◇ La colonna si può ridurre in profondità, senza maggiorazioni di prezzo fino a 35cm								
	• OVER COLUM H.60 - 2 DOORS With a internal adjustabl shelf		◇ The tall unit can be reduced in depth, without price surcharge up to 35cm								
	Da/From 66 a/to 95	S3095	758	764	781	790	856	863	1.047	-	-
	Da/From 96 a/to 130	S3130	906	916	939	945	1.041	1.024	1.215	-	-

FASCIE DI TAMPONAMENTO LATERALE E FIANCHI A VISTA PER COLONNE SIDE FINISHER AND FINISHING SIDE FOR COLUMNS

• I prezzi NON comprendono lo zoccolo • Prices do NOT included the plinth

Elemento Unit	Altezza Hight	Codice Code	1	2	3	4	5	6	7	8	9
------------------	------------------	----------------	---	---	---	---	---	---	---	---	---

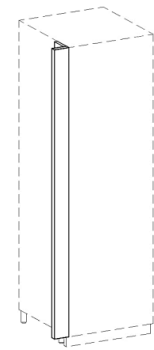

• FASCIA DI TAMPONAMENTO LATERALE PER COLONNA

Larghezza 2÷15 cm

• LATERAL DAMPING BAND FOR COLUMN

Width 2÷15 cm

Altezza/Hight 141	TC141	106	89	116	116	112	106	106	112	-
Altezza/Hight 204	TC204	135	112	149	145	155	139	139	152	-
Altezza/Hight 219	TC219	142	119	158	152	168	149	149	162	-
Altezza/Hight 234	TC234	149	126	165	162	178	155	155	168	-
Altezza/Hight 264	TC249	158	129	175	168	188	162	162	178	-

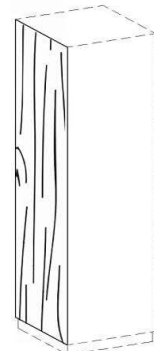

• SUPPLEMENTO PER FIANCO PERSONALIZZATO COLONNA

◇ Per colonne di profondità da 35 fino a 65cm

• SURCHARGE FOR PERSONALIZED SIDE PANEL COLUMN

◇ On columns from 35 to 65cm deep

Altezza/Hight 141	FWC141	191	185	224	297	349	185	185	185	-
Altezza/Hight 204	FWC204	257	251	307	412	507	251	251	251	-
Altezza/Hight 219	FWC219	274	267	323	442	544	267	267	267	-
Altezza/Hight 234	FWC234	290	284	343	468	580	284	284	284	-
Altezza/Hight 264	FWC264	320	316	382	524	652	316	316	316	-

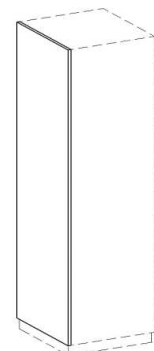

• FIANCO DI FINITURA A RIPORTO PER COLONNA (SOSPESO)

Spessore 2cm

◇ Senza differenza di prezzo, per fianchi di finitura in profondità da 35 fino a 65cm

• CARRIED OVER FINISHING SIDE FOR COLUMN (SUSPENDED)

Thickness 2cm

◇ No price difference on finishing side panels from 35 to 65cm depth.

Altezza/Hight 141	FRC141	267	297	310	389	501	297	297	297	-
Altezza/Hight 204	FRC204	363	412	425	544	711	412	412	412	-
Altezza/Hight 219	FRC219	386	438	451	583	761	438	438	438	-
Altezza/Hight 234	FRC234	409	465	481	619	814	465	465	465	-
Altezza/Hight 264	FRC264	458	517	537	692	912	517	517	517	-

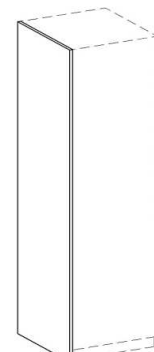

• FIANCO DI FINITURA A RIPORTO PER COLONNA (FINO A TERRA)

Spessore 2cm

◇ Senza differenza di prezzo, per fianchi di finitura in profondità da 35 fino a 65cm

• CARRIED OVER FINISHING SIDE FOR COLUMN (DOWN TO THE GROUND)

Thickness 2cm

◇ No price difference on finishing side panels from 35 to 65cm depth.

Altezza/Hight 149	FRC149	277	310	323	409	527	310	310	310	-
Altezza/Hight 212	FRC212	376	425	438	563	738	425	425	425	-
Altezza/Hight 227	FRC227	399	451	468	603	787	451	451	451	-
Altezza/Hight 242	FRC242	422	478	494	639	840	478	478	478	-
Altezza/Hight 272	FRC272	468	534	550	711	939	534	534	534	-

PROGRAMMA COLONNE CON ANTA RIENTRANTE TALL UNITS PROGRAM WHIT LEAF FALLING

ESEMPI DI ACCOSTO / POSITIONING EXAMPLES

Colonna con anta rientrante intermedia solo su modulo forni
Tall unit with retracting door only recessed on ovens

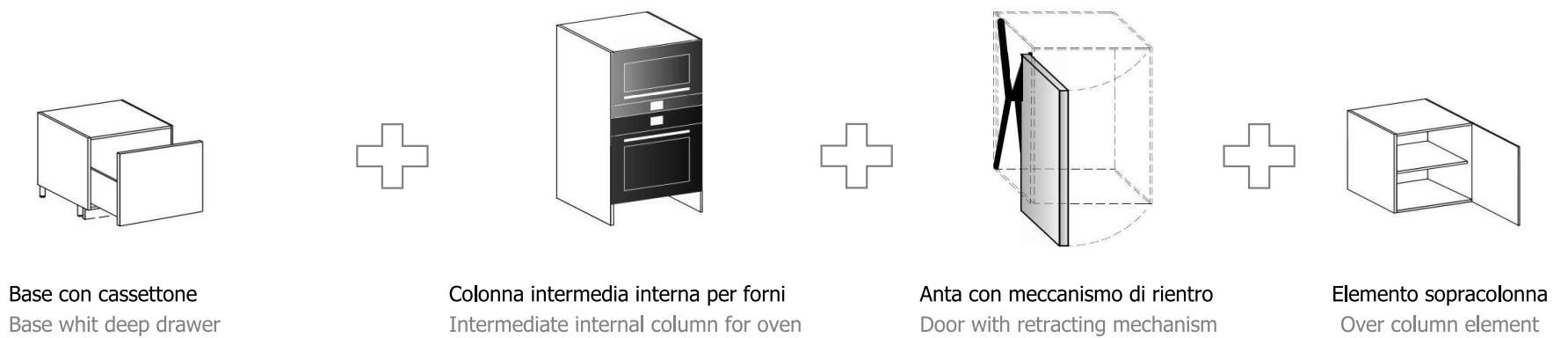

Base con cassettoni
Base whit deep drawer

Colonna intermedia interna per forni
Intermediate internal column for oven

Anta con meccanismo di rientro
Door with retracting mechanism

Elemento sopra colonna
Over column element

Colonna con anta rientrante
Tall unit with with retracting door

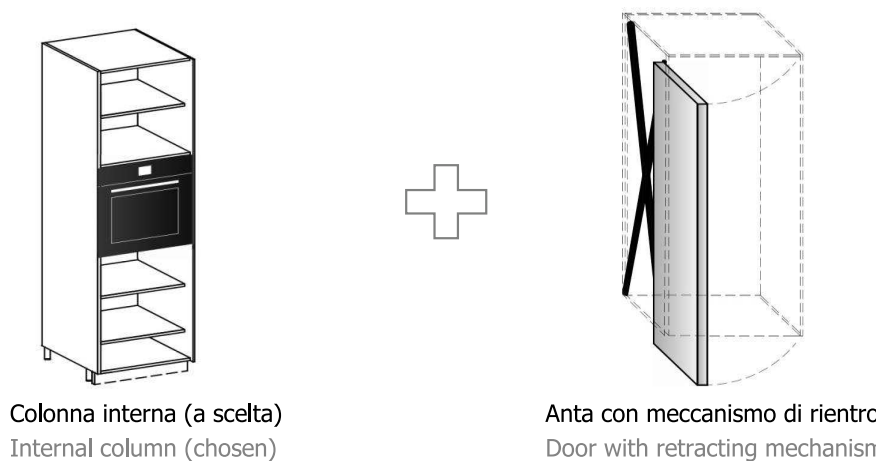

Colonna interna (a scelta)
Internal column (chosen)

Anta con meccanismo di rientro
Door with retracting mechanism

Colonna con doppia anta rientrante e vano intrno da attrezzare a progetto
Tall unit with two doors retracting doors with interior space equipment at the project

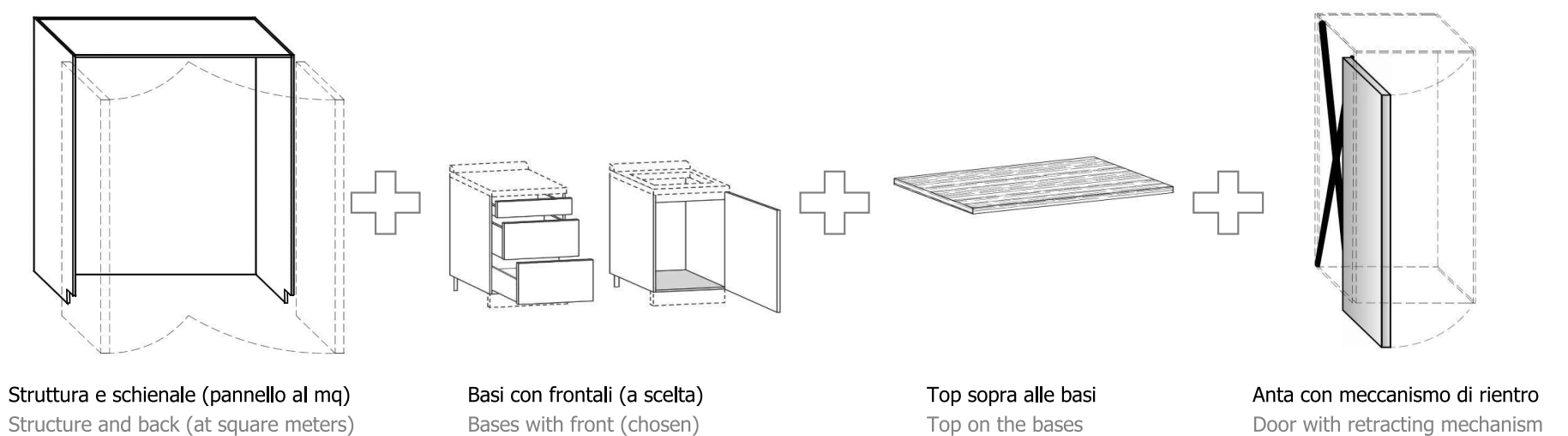

Struttura e schienale (pannello al mq)
Structure and back (at square meters)

Basi con frontali (a scelta)
Bases with front (chosen)

Top sopra alle basi
Top on the bases

Anta con meccanismo di rientro
Door with retracting mechanism

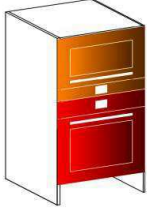
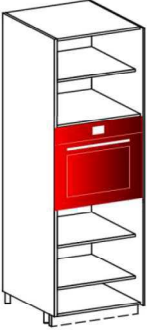
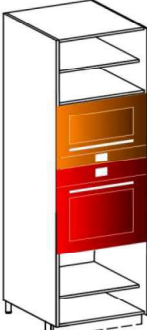
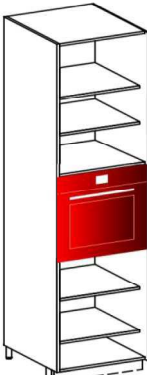

PROGRAMMA COLONNE CON ANTA RIENTRANTE TALL UNITS PROGRAM WHIT LEAF FALLING

• I prezzi NON comprendono maniglie e zoccolo • Prices do NOT included the handles and the plinth

Elemento Unit	Finitura Finish	Dimensioni Dimension	Codice Code	Prezzo Price
	<ul style="list-style-type: none"> • COLONNA INTERMEDIA INTERNA PER FORNO + MICROONDE Colonna h. 120 cm • INTERMEDIATE INTERNAL COLUMN FOR OVEN + MICROWAVE Tall unit h 120 cm 	Largh./Width 64,5 cm	C1F064H	494
	<ul style="list-style-type: none"> • COLONNA INTERNA PER FORNO CON 2 VANI Colonna h. 212 cm con 3 ripiani interni regolabili • COLUMN INTERNAL FOR OVEN WITH 2 COMPARTMENT Tall unit h 212 cm with 3 internal adjustable shelves 	Largh./Width 64,5 cm	C2F064R	1.037
	<ul style="list-style-type: none"> • COLONNA INTERNA PER FORNI CON 2 VANI Colonna h. 212 cm con 2 ripiani interni regolabili • COLUMN INTERNAL FOR OVENS WITH 2 COMPARTMENT Tall unit h 212 cm with 2 internal adjustable shelves 	Largh./Width 64,5 cm	C2FM064R	995
	<ul style="list-style-type: none"> • COLONNA INTERNA PER FORNO CON 2 VANI Colonna h.242 cm con 4 ripiani interni regolabili • COLUMN INTERNAL FOR OVEN WITH 2 COMPARTMENT Tall unit h 242 cm with 4 internal adjustable shelves 	Largh./Width 64,5 cm	C4F064R	1.189

PROGRAMMA COLONNE CON ANTA RIENTRANTE TALL UNITS PROGRAM WHIT LEAF FALLING

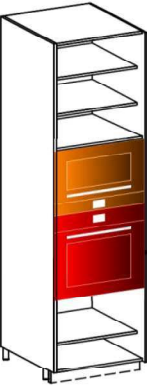
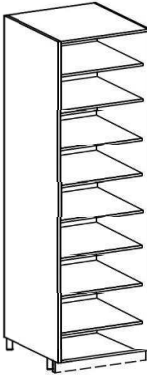
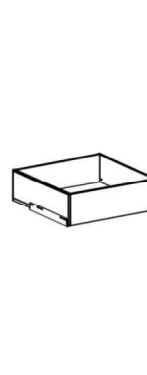
• I prezzi NON comprendono maniglie e zoccolo • Prices do NOT included the handles and the plinth

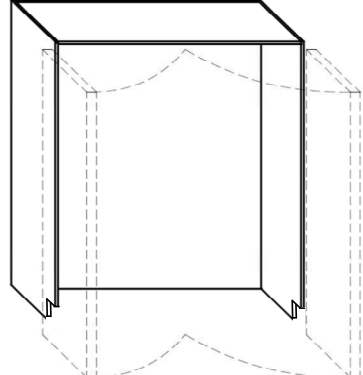
Elemento Unit	Finitura Finish	Dimensioni Dimension	Codice Code	Prezzo Price
	<ul style="list-style-type: none"> • COLONNA INTERNA PER FORNI CON 2 VANI Colonna h. 242 cm con 3 ripiani interni regolabili • COLUMN INTERNAL FOR OVENS WITH 2 COMPARTMENT Tall unit h 242 cm with 3 internal adjustable shelves 	Largh./Width 64,5 cm	C4FM064R	1.146
	<ul style="list-style-type: none"> • COLONNA INTERNA A GIORNO Con 1 piano fisso e ripiani interni regolabili • COLUMN INTERNAL With 1 fixed shelv and internal adjustable shelves 	Altezza /Hight 212 cm Largh. /Width 64,5 cm	C2G064R	1.149
	Altezza /Hight 212 cm Largh. /Width 64,5 cm	C4G064R	1.304	
	<ul style="list-style-type: none"> • CASSETTO INTERNO LEGRABOX-M / LEGNO (INGOMBRO MINIMO H.10,4) Profondità e portata in base alle misure del vano • DRAWER INTERNAL LEGRABOX-M / WOOD (MINIMUM ENCUMBRANCE H.10,4) The depth depends on the measures of the compartment 	Cassetto Legrabox /Legrabox drawer Largh. da /Width from 20 a/to 95	OPZLGR_M	195
	Cassetto in legno /Wood drawer Largh. da /Width from 20 a/to 95	OPZLGN_M	224	
	<ul style="list-style-type: none"> • STRUTTURA E SCHIENALE VANI CON ANTE RIENTRANTI Valore pannello al mq Minimo conteggiabile 0,6 mq • SUPPORT FOR MECHANISMS DOORS COVERED Panel value for square metre Countable minimum 0,6 square meters 	Spessore 1,8 cm /Thickness 1,8 cm	MRSTR	162

PROGRAMMA COLONNE CON ANTA RIENTRANTE TALL UNITS PROGRAM WHIT LEAF FALLING

• I prezzi NON comprendono maniglie e zoccolo • Prices do NOT included the handles and the plinth

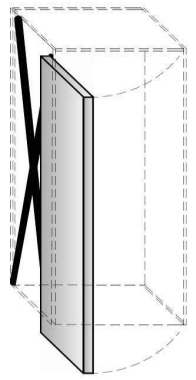
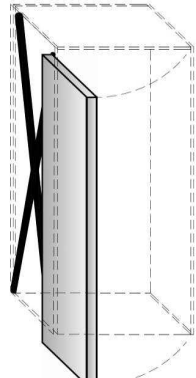
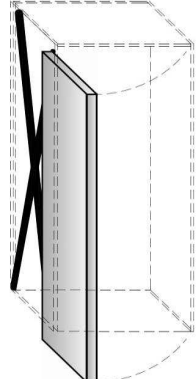
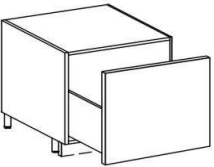
Elemento Unit	Altezza Hight	Codice Code	1	2	3	4	5	6	7	8	9
	<ul style="list-style-type: none"> • MECCANISMO CON ANTA RIENTRANTE Altezza da 120 a 200 cm • MECHANISM WITH DOOR COVERED Hight from 120 to 200 cm 		5,5		5,5		5,5				
	Per colonne interne P. 70÷75 For columns internal W 70÷75	MR185	2.189	2.226	2.249	2.268	2.472	2.288	2.446	-	-
	<ul style="list-style-type: none"> • MECCANISMO CON ANTA RIENTRANTE Altezza da 212 cm • MECHANISM WITH DOOR COVERED Hight from 212 cm 		5,5		5,5		5,5				
	Per colonne interne P.70÷75 For columns internal W 70÷75	MR212	2.446	2.486	2.509	2.528	2.752	2.551	2.713	-	-
	<ul style="list-style-type: none"> • MECCANISMO CON ANTA RIENTRANTE Altezza da 227 a 242 cm • MECHANISM WITH DOOR COVERED Hight from 227 to 242 cm 		5,5		5,5		5,5				
	Per colonne interne P. 70÷75 For columns internal W 70÷75	MR242	2.499	2.542	2.568	2.594	2.851	2.611	2.788	-	-
	<ul style="list-style-type: none"> • BASE CON CASSETTONE Per appoggio colonna forni. Altezza 62 cm • BASE WITH DEEP DRAWER Support tall unit for oven. Height 62 cm 										
	Da/From 70 a/to 95 Da/From 96 a/to 130	B095R B130R	814 962	823 975	837 988	840 995	909 1.093	883 1.041	985 1.149	- -	- -

OPZIONI PER COLONNE OPTIONS FOR COLUMNS

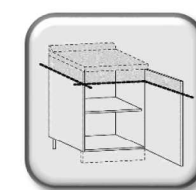

- **SUPPLEMENTO PER RIDUZIONE MOBILE IN ALTEZZA**
- **SURCHARGE FOR REDUCTION HEIGHT OF A FURNITURE**

Per ogni colonna/For each tall unit

OPZHC

53

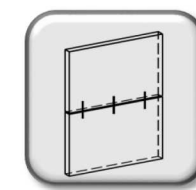

- **SUPPLEMENTO PER ANTA COMPOSTA DA DUE FRONTALI UNITI TRA LORO**
- **SURCHARGE FOR DOOR COMPOSED BY TWO JOINED TOGETHER FRONTS**

Per ogni anta/For each door

OPZAU

47

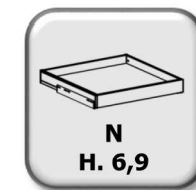

- **CASSETTO INTERNO LEGRABOX-N O LEGNO (INGOMBRO MINIMO H.8)**
Profondità e portata in base alle misure del vano o su specifica richiesta
- **DRAWER INTERNAL LEGRABOX-N (MINIMUM ENCUMBRANCE H.8)**
The depth depends on the measures of the compartment or on special request

CASSETTO LEGRABOX
Largh. da/Width from **20** a/to **95**
CASSETTO IN LEGNO
Largh. da/Width from **20** a/to **95**

OPZLGR_N

198

OPZLGN_N

214

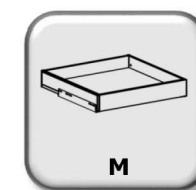

- **CASSETTO INTERNO LEGRABOX-M O LEGNO (INGOMBRO MINIMO H.10,4)**
Profondità e portata in base alle misure del vano o su specifica richiesta
- **DRAWER INTERNAL LEGRABOX-M (MINIMUM ENCUMBRANCE H.10,4)**
The depth depends on the measures of the compartment or on special request

CASSETTO LEGRABOX
Largh. da/Width from **20** a/to **95**
CASSETTO IN LEGNO
Largh. da/Width from **20** a/to **95**

OPZLGR_M

195

OPZLGN_M

224

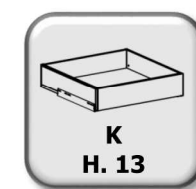

- **CASSETTO INTERNO LEGRABOX-K O LEGNO (INGOMBRO MINIMO H.14,4)**
Profondità e portata in base alle misure del vano o su specifica richiesta
- **DRAWER INTERNAL LEGRABOX-K (MINIMUM ENCUMBRANCE H.14,4)**
The depth depends on the measures of the compartment or on special request

CASSETTO LEGRABOX
Largh. da/Width from **20** a/to **95**
CASSETTO IN LEGNO
Largh. da/Width from **20** a/to **95**

OPZLGR_K

218

OPZLGN_K

237

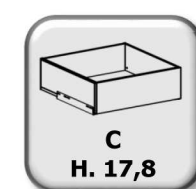

- **CASSETTO INTERNO LEGRABOX-C O LEGNO (INGOMBRO MINIMO H.19,3)**
Profondità e portata in base alle misure del vano o su specifica richiesta
- **DRAWER INTERNAL LEGRABOX-C (MINIMUM ENCUMBRANCE H.19,3)**
The depth depends on the measures of the compartment or on special request

CASSETTO LEGRABOX
Largh. da/Width from **20** a/to **95**
CASSETTO IN LEGNO
Largh. da/Width from **20** a/to **95**

OPZLGR_C

231

OPZLGN_C

257

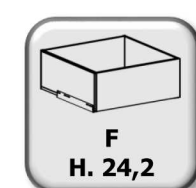

- **CASSETTO INTERNO LEGRABOX-F O LEGNO (INGOMBRO MINIMO H.19,3)**
Profondità e portata in base alle misure del vano o su specifica richiesta
- **DRAWER INTERNAL LEGRABOX-F (MINIMUM ENCUMBRANCE H.19,3)**
The depth depends on the measures of the compartment or on special request

CASSETTO LEGRABOX
Largh. da/Width from **20** a/to **95**
CASSETTO IN LEGNO
Largh. da/Width from **20** a/to **95**

OPZLGR_F

284

OPZLGN_F

284

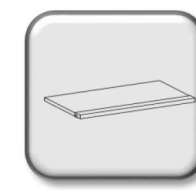

- **RIPIANO INTERNO IN AGGIUNTA**
Profondità e larghezza in base alle misure del vano o su specifica richiesta
- **INTERNAL SHELF IN ADDITON**
Depth and width according to the measurements of the recess or on specific request

Per ogni ripiano/For each shelf

OPZRPC

96



PENSILI
WALL UNITS

PENSILI
WALL UNITS

Prof. Depth **40**

Altezza Height **48+63**

• I prezzi NON comprendo maniglie o cornici superiori • Prices do NOT included the handles, the groove, the worktop, or upstand and the plinth

Elemento Unit	Larghezza Width	Codice Code	1	2	3	4	5	6	7	8	9
---------------	-----------------	-------------	---	---	---	---	---	---	---	---	---

• **PENSILE 1 ANTA PLANARE VERTICALE HL**

Con ripiano interno regolabile

◊ Il pensile si può ridurre in profondità, senza maggiorazioni di prezzo fino a 35cm

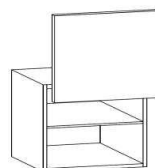

• **WALL UNIT WITH VERTICAL LIFT DOOR HL**

With one internal adjustable shelves

◊ The wall unit can be reduced in depth, without price increases up to 35cm

Da/From 20 a/to 45	P2045RL	642	646	656	-	695	698	790	-	-
Da/From 45 a/to 65	P2065RL	705	711	721	-	777	764	863	-	-
Da/From 60 a/to 95	P2095RL	827	840	853	-	942	899	1.004	-	-
Da/From 95 a/to 130	P2130RL	1.228	1.264	1.294	-	1.541	1.399	1.623	-	-



• **PENSILE 1 ANTA VETRO PLANARE VERTICALE HL**

Con ripiano interno regolabile

◊ Il pensile si può ridurre in profondità, senza maggiorazioni di prezzo fino a 35cm

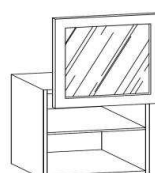

• **WALL UNIT WITH VERTICAL LIFT GLASS DOOR HL**

With one internal adjustable shelves

◊ The wall unit can be reduced in depth, without price increases up to 35cm

Da/From 20 a/to 45	P2045RLV	-	-	-	-	-	698	790	958	-
Da/From 45 a/to 65	P2065RLV	-	-	-	-	-	764	863	1.087	-
Da/From 60 a/to 95	P2095RLV	-	-	-	-	-	1.202	1.413	2.081	-
Da/From 95 a/to 130	P2130RLV	-	-	-	-	-	1.097	1.212	1.656	-



• **PENSILE ANGOLO CON 1 ANTA**

Con ripiano interno regolabile

◊ Il pensile si può ridurre in profondità, senza maggiorazioni di prezzo fino a 35cm

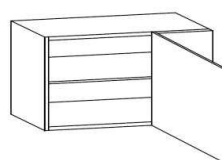

• **CORNER WALL UNIT WITH 1 DOOR**

With one internal adjustable shelves

◊ The wall unit can be reduced in depth, without price increases up to 35cm

Da/From 65x40 (anta 20) a/to 110x40 (anta 65)	P2A110	705	705	721	-	774	758	856	-	-
--	---------------	-----	-----	-----	---	-----	-----	-----	---	---



• **PENSILE ANGOLO CON 2 ANTE**

Con ripiano interno regolabile

◊ Il pensile si può ridurre in profondità, senza maggiorazioni di prezzo fino a 35cm

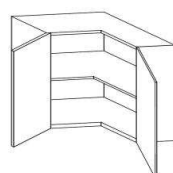

• **CORNER WALL UNIT WITH 2 DOORS**

With one internal adjustable shelves

◊ The wall unit can be reduced in depth, without price increases up to 35cm

Da/From 60x60 (anta 20) a/to 110x110 (anta 65)	P2A110B	1.159	1.176	1.199	-	1.330	1.287	1.485	-	-
---	----------------	-------	-------	-------	---	-------	-------	-------	---	---



PENSILI
WALL UNITS

Prof. Depth **40**

Altezza Height **48+63**

• I prezzi NON comprendo maniglie o cornici superiori • Prices do NOT included the handles, the groove, the worktop, or upstand and the plinth

Elemento Unit	Larghezza Width	Codice Code	1	2	3	4	5	6	7	8	9
---------------	-----------------	-------------	---	---	---	---	---	---	---	---	---

• **PENSILE A GIORNO IN ESSENZA CON TELAIO FRONTALE A FILO**

Con ripiano interno regolabile

◊ Il pensile si può ridurre in profondità, senza maggiorazioni di prezzo fino a 35cm

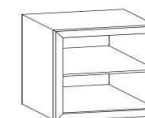

• **OPEN WALL UNIT IN ESSENCE WITH FRAME FRONT**

With one internal adjustable shelves

◊ The wall unit can be reduced in depth, without price increases up to 35cm

Da/From 20 a/to 45	P2045G	-	461	-	-	471	465	465	-	-
Da/From 45 a/to 65	P2065G	-	517	-	-	527	521	521	-	-
Da/From 60 a/to 95	P2095G	-	629	-	-	639	629	629	-	-
Da/From 95 a/to 130	P2130G	-	738	-	-	748	741	741	-	-

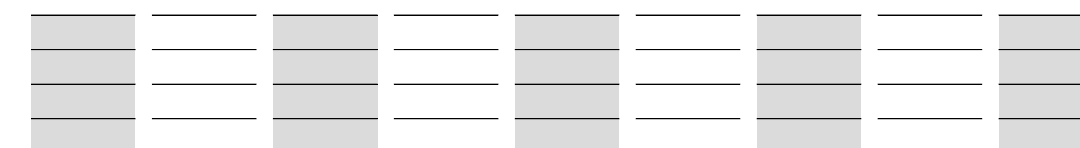
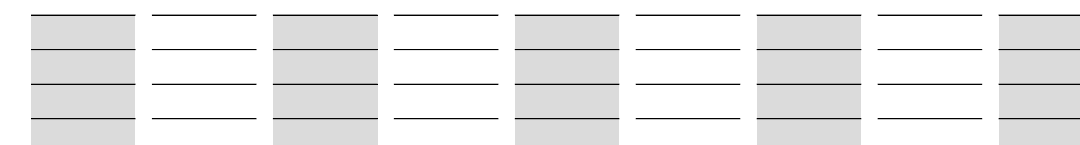
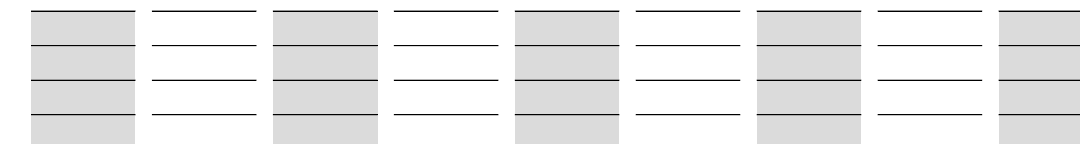

PENSILI
WALL UNITS

Prof. Depth **40**

Altezza Height **78+93**

• I prezzi NON comprendo maniglie o cornici superiori • Prices do NOT included the handles, the groove, the worktop, or upstand and the plinth

Elemento Unit	Larghezza Width	Codice Code	1	2	3	4	5	6	7	8	9
---------------	-----------------	-------------	---	---	---	---	---	---	---	---	---

• **PENSILE 1 ANTA**

Con due ripiani interni regolabili

◊ Il pensile si può ridurre in profondità, senza maggiorazioni di prezzo fino a 35cm

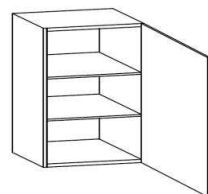

• **WALL UNIT 1 DOOR**

With two internal adjustable shelves

◊ The wall unit can be reduced in depth, without price increases up to 35cm



Da/From **20 a/to 45** **P4045**
Da/From **45 a/to 65** **P4065**

			570	577	590	-	652	632	738	-	-
			659	669	682	-	771	725	837	-	-

• **PENSILE 2 ANTE**

Con due ripiani interni regolabili

◊ Il pensile si può ridurre in profondità, senza maggiorazioni di prezzo fino a 35cm

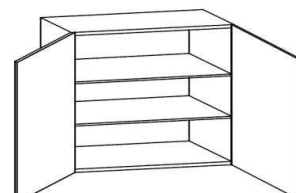

• **WALL UNIT 2 DOORS**

With two internal adjustable shelves

◊ The wall unit can be reduced in depth, without price increases up to 35cm



Da/From **60 a/to 95** **P4095**
Da/From **95 a/to 130** **P4130**

			922	935	958	-	1.083	1.044	1.258	-	-
			1.100	1.123	1.149	-	1.324	1.235	1.455	-	-

• **PENSILE 1 ANTA VETRO**

Con due ripiani interni regolabili

◊ Il pensile si può ridurre in profondità, senza maggiorazioni di prezzo fino a 35cm

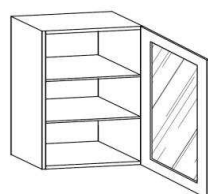

• **WALL UNIT 1 GLASS DOOR**

With two internal adjustable shelves

◊ The wall unit can be reduced in depth, without price increases up to 35cm



Da/From **20 a/to 45** **P4045V**
Da/From **45 a/to 65** **P4065V**

			-	-	-	-	-	632	738	1.001	-
			-	-	-	-	-	725	837	1.182	-

• **PENSILE 2 ANTE VETRO**

Con due ripiani interni regolabili

◊ Il pensile si può ridurre in profondità, senza maggiorazioni di prezzo fino a 35cm

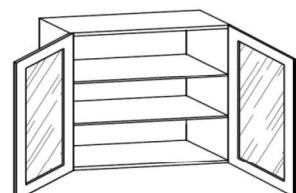

• **WALL UNIT 2 GLASS DOORS**

With two internal adjustable shelves

◊ The wall unit can be reduced in depth, without price increases up to 35cm



Da/From **60 a/to 95** **P4095V**
Da/From **95 a/to 130** **P4130V**

			-	-	-	-	-	1.044	1.258	1.785	-
			-	-	-	-	-	1.235	1.455	2.150	-

PENSILI
WALL UNITS

Prof. Depth **40**

Altezza Height **78+93**

• I prezzi NON comprendo maniglie o cornici superiori • Prices do NOT included the handles, the groove, the worktop, or upstand and the plinth

Elemento Unit	Larghezza Width	Codice Code	1	2	3	4	5	6	7	8	9
---------------	-----------------	-------------	---	---	---	---	---	---	---	---	---

• **PENSILE ANGOLO CON 1 ANTA**

Con due ripiani interni regolabili

◊ Il pensile si può ridurre in profondità, senza maggiorazioni di prezzo fino a 35cm

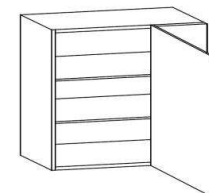

• **CORNER WALL UNIT WITH 1 DOOR**

With two internal adjustable shelves

◊ The wall unit can be reduced in depth, without price increases up to 35cm



Da/From **65x40** (anta 20) **P4A110**
a/to **110x40** (anta 65)

			935	939	962	-	1.047	998	1.106	-	-

• **PENSILE ANGOLO CON 2 ANTE**

Con due ripiani interni regolabili

◊ Il pensile si può ridurre in profondità, senza maggiorazioni di prezzo fino a 35cm

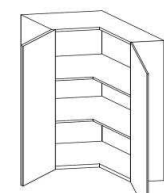

• **CORNER WALL UNIT WITH 2 DOORS**

With two internal adjustable shelves

◊ The wall unit can be reduced in depth, without price increases up to 35cm



Da/From **60x60** (anta 20) **P4A110B**
a/to **110x110** (anta 65)

			1.577	1.607	1.633	-	1.844	1.722	1.949	-	-

• **PENSILE A GIORNO IN ESSENZA CON TELAIO FRONTALE A FILO**

Con ripiano interno regolabile

◊ Il pensile si può ridurre in profondità, senza maggiorazioni di prezzo fino a 35cm



• **OPEN WALL UNIT IN ESSENCE WITH FRAME FRONT**

With two internal adjustable shelves

◊ The wall unit can be reduced in depth, without price increases up to 35cm



Da/From **20 a/to 45** **P4045G**
Da/From **45 a/to 65** **P4065G**
Da/From **60 a/to 95** **P4095G**
Da/From **95 a/to 130** **P4130G**

			-	642	-	-	603	590	590	-	-
			-	715	-	-	675	662	662	-	-
			-	860	-	-	817	804	804	-	-
			-	1.001	-	-	962	948	948	-	-

FASCIE DI TAMPONAMENTO LATERALE E FIANCHI A VISTA PER PENSILI SIDE FINISHER AND FINISHING SIDE FOR WALL UNIT

• I prezzi NON comprendono lo zoccolo • Prices do NOT included the plinth

Elemento Unit	Altezza Hight	Codice Code	1	2	3	4	5	6	7	8	9
------------------	------------------	----------------	---	---	---	---	---	---	---	---	---

• FASCIA DI TAMPONAMENTO LATERALE PER PENSILE

Larghezza 2÷15 cm

• LATERAL DAMPING BAND FOR WALL UNIT

Width 2÷15 cm

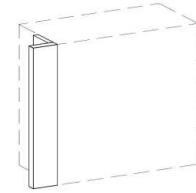

Altezza/Hight	48	TP048	56	50	60	63	47	53	53	56	-
Altezza/Hight	63	TP063	63	56	66	73	60	63	63	63	-
Altezza/Hight	78	TP078	70	63	76	79	70	70	70	73	-
Altezza/Hight	93	TP093	79	66	83	86	79	76	76	83	-
Altezza/Hight	123	TP123	96	83	106	106	103	96	96	103	-

• SUPPLEMENTO PER FIANCO PERSONALIZZATO PENSILE

◊ Per pensili di profondità da 35 fino a 40cm

• SURCHARGE FOR PERSONALIZED SIDE PANEL WALL UNIT

◊ On wall units from 35 to 40cm deep

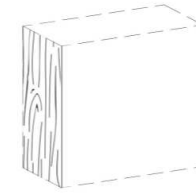

Altezza/Hight	48	FWP048	76	60	83	86	76	60	60	60	-
Altezza/Hight	63	FWP063	86	73	96	103	99	73	73	73	-
Altezza/Hight	78	FWP078	96	83	109	119	122	83	83	83	-
Altezza/Hight	93	FWP093	106	93	119	139	145	93	93	93	-
Altezza/Hight	123	FWP123	129	112	145	178	191	112	112	112	-

• FIANCO DI FINITURA A RIPORTO PER PENSILE

Spessore 2cm

◊ Per pensili di profondità da 35 fino a 40cm

• CARRIED OVER FINISHING SIDE FOR WALL UNIT (SUSPENDED)

Thickness 2cm

◊ On wall units from 35 to 40cm deep

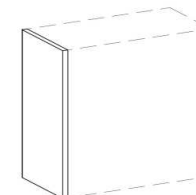

Altezza/Hight	48	FRP048	89	96	99	116	135	96	96	96	-
Altezza/Hight	63	FRP063	106	112	119	139	168	112	112	112	-
Altezza/Hight	78	FRP078	122	129	135	162	201	129	129	129	-
Altezza/Hight	93	FRP093	135	145	155	185	234	145	145	145	-
Altezza/Hight	123	FRP123	165	182	191	237	303	182	182	182	-

• PANNELLO DI FINITURA PER PENSILE

Prezzo al metro lineare

Minimo conteggiabile 0,4m

◊ Per pensili di profondità da 35 fino a 40cm

• FINISHING PANEL FOR WALL UNIT

Value per linear metre. Min. amount 0,4m

◊ On wall units from 35 to 40cm deep

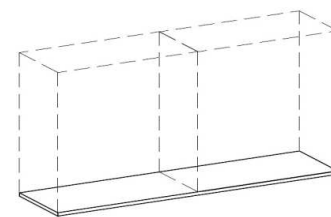

Pannello in Essenza/Panel in essence

Lungh./Lenght max. 2,4m

FP000

93

OPZIONI PER PENSILI OPTIONS FOR WALL UNITS

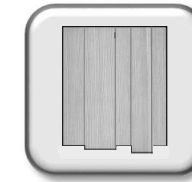

• SUPPLEMENTO PER ANTE CON LAVORAZIONE "RANDOM" SU UN LATO

• SURCHARGE TO DOOR WITH PROCESSING "RANDOM"

Per ogni anta/For each door

OPZRN

89

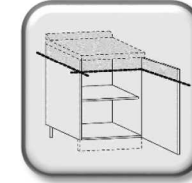

• SUPPLEMENTO PER RIDUZIONE MOBILE IN ALTEZZA

• SURCHARGE FOR REDUCTION HEIGHT OF A FURNITURE

Per ogni pensile/For each wall unit

OPZHP

37

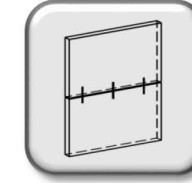

• SUPPLEMENTO PER ANTA COMPOSTA DA DUE FRONTALI UNITI TRA LORO

• SURCHARGE FOR DOOR COMPOSED BY TWO JOINED TOGETHER FRONTS

Per ogni anta/For each door

OPZAU

47

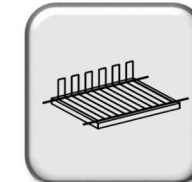

• SCOLAPIATTI 1 MODULO PER PENSILE

Elemento in filo metallico con griglia reggi piatti e vassoio

• PLATE RACK 1 ELEMENT FOR EACH WALL UNIT

Element in metal thread with grill and tray

Largh./Width **45**

Largh./Width **60**

Largh./Width **80**

Largh./Width **90**

Largh./Width **120**

SC1045

SC1060

SC1080

SC1090

SC1120

122

132

155

165

208

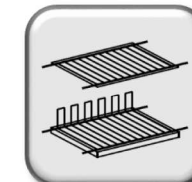

• SCOLAPIATTI 2 MODULI PER PENSILE

Elementi in filo metallico con griglia reggi piatti e vassoio

• PLATE RACK 2 ELEMENTS FOR EACH WALL UNIT

Elements in metal thread with grill and tray

Largh./Width **45**

Largh./Width **60**

Largh./Width **80**

Largh./Width **90**

Largh./Width **120**

SC2045

SC2060

SC2080

SC2090

SC2120

162

175

205

218

313



• PREDISPOSIZIONE PENSILE PER INSERIMENTO ASPIRATORE INCASSO

Aspiratore non incluso

• ARRANGEMENT WALL UNIT FOR INSERTION BUILT IN EXTRACTOR FAN

Extractor fan not included

Largh. da/Width from **60 a/to 130**

OPZINC

198

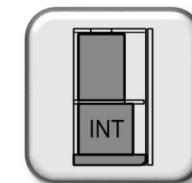

• PREDISPOSIZIONE PENSILE PER INSERIMENTO ASPIRATORE INTEGRATO

Aspiratore non incluso

• ARRANGEMENT WALL UNIT FOR INSERTION INTEGRATED EXTRACTOR FAN

Extractor fan not included

Largh. da/Width from **60 a/to 130**

OPZINT

73



• PREDISPOSIZIONE PENSILE PER INSERIMENTO ASPIRATORE TELESCOPICO

Aspiratore non incluso

• ARRANGEMENT WALL UNIT FOR INSERTION TELESCOPIC EXTRACTOR FAN

Extractor fan not included

Largh. da/Width from **60 a/to 130**

OPZTEL

152



• PREDISPOSIZIONE PENSILE PER INSERIMENTO ASPIRATORE ESTRAIBILE

Aspiratore non incluso

• ARRANGEMENT WALL UNIT FOR INSERTION EXTRACTABLE EXTRACTOR FAN

Extractor fan not included

Largh. da/Width from **60 a/to 130**

OPZEST





149



MANIGLIE GOLE ZOCCOLI
HANDLESS GROOVE PLINTH





MANIGLIE HANDLESS

• Le eventuali maniglie sono **SEMPRE** da aggiungere al prezzo dei mobili • Any handles are **ALWAYS** to be added to the price of the furniture







Elemento Unit	Finitura Finish	Dimensioni Dimension	Misura passo Measure Pitch	Posizionamento Positioning	Codice Code	Prezzo Price
	<ul style="list-style-type: none"> • MANIGLIA "CATENACCIO" Non posizionabile su ante con cerniere a sinistra • HANDLE "CATENACCIO" Not adjustable on doors with left hinges 					
	Finitura epossidica/Epoxy finish: Antracite	150 X 45 X 32mm	78mm	Orizzontale • Horizontal	CATMA	79
	Finitura epossidica/Epoxy finish: Champagne	150 X 45 X 32mm	78mm	Orizzontale • Horizontal	CATMC	79
	<ul style="list-style-type: none"> • MANIGLIA "CATENACCIO" Posizionabile su ante con cerniere o con aperture a traslare • HANDLE "CATENACCIO" Adjustable on doors with hinges or shift opening 					
	Finitura epossidica/Epoxy finish: Antracite	150 X 19 X 32mm	78mm	Orizzontale • Horizontal	CATFA	76
	Finitura epossidica/Epoxy finish: Champagne	150 X 19 X 32mm	78mm	Orizzontale • Horizontal	CATFC	76
	<ul style="list-style-type: none"> • MANIGLIA "LEVA" • HANDLE "LEVA" 					
	Finitura epossidica/Epoxy finish: Antracite	110 X 24 X 25mm	32mm	Oriz./Vert. • Horiz./Vert.	LEVAA	60
	Finitura epossidica/Epoxy finish: Champagne	110 X 24 X 25mm	32mm	Oriz./Vert. • Horiz./Vert.	LEVAC	60
	<ul style="list-style-type: none"> • POMOLO ROTONDO "CORK" • ROUND KNOB "CORK" 					
	Sughero naturale / Natural Cork	∅ 45 X 30mm	----	Oriz./Vert. • Horiz./Vert.	CORK045	56
	Sughero naturale / Natural Cork	∅ 70 X 37mm	----	Oriz./Vert. • Horiz./Vert.	CORK070	63

MANIGLIE HANDLESS

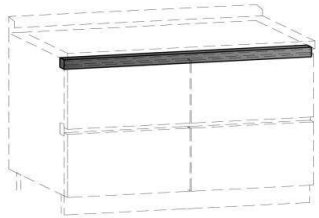
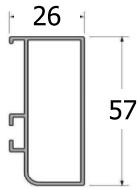

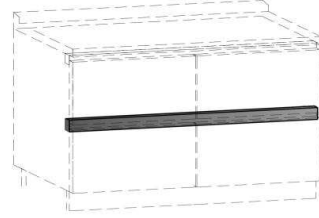
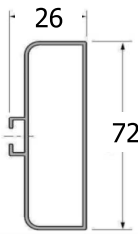

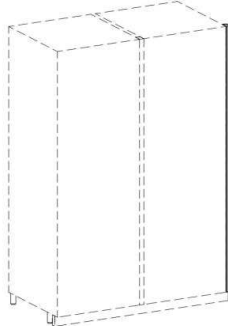
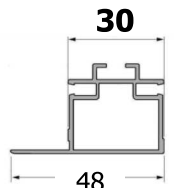

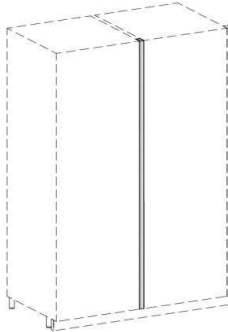
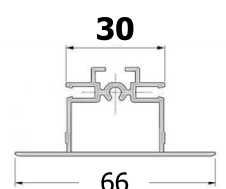
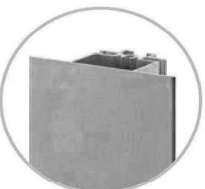
• Le eventuali maniglie sono **SEMPRE** da aggiungere al prezzo dei mobili • Any handles are **ALWAYS** to be added to the price of the furniture

Elemento Unit	Finitura Finish	Dimensioni Dimension	Misura passo Measure Pitch	Posizionamento Positioning	Codice Code	Prezzo Price
	<ul style="list-style-type: none"> • MANIGLIA "886" • HANDLE "886" 					
	Cromo lucido / Polished chrome	110 X 13 X 15mm 175 X 13 X 15mm	96mm 160mm	Oriz./Vert. • Horiz./Vert.	MN886C110	30
	Nichel satinato lucido / Shiny satin nickel	110 X 13 X 15mm 175 X 13 X 15mm	96mm 160mm	Oriz./Vert. • Horiz./Vert.	MN886N110	30
	Nichel satinato lucido / Shiny satin nickel	110 X 13 X 15mm 175 X 13 X 15mm	96mm 160mm	Oriz./Vert. • Horiz./Vert.	MN886N175	33
	<ul style="list-style-type: none"> • MANIGLIA "935" • HANDLE "935" 					
	Cromo lucido / Polished chrome	138 X 10 X 32mm	128mm	Oriz./Vert. • Horiz./Vert.	MN935C138	37
	<ul style="list-style-type: none"> • POMOLO "319" • KNOB "319" 					
	Cromo lucido / Polished chrome	25 X 25 X 21 mm		Oriz./Vert. • Horiz./Vert.	P0319C025	24
	Nichel satinato lucido / Shiny satin nickel	25 X 25 X 21 mm		Oriz./Vert. • Horiz./Vert.	P0319N025	24
	<ul style="list-style-type: none"> • MANIGLIA "1071" • HANDLE "1071" 					
	Nichel satinato lucido / Shiny satin nickel	148 X 30 X 20 mm		Oriz./Vert. • Horiz./Vert.	MN1071N128	37

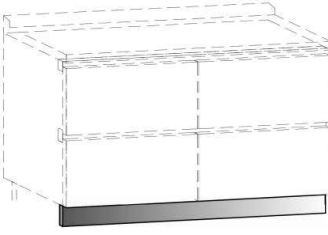
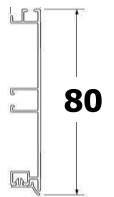
PROFILI GOLA GROOVE PROFILE

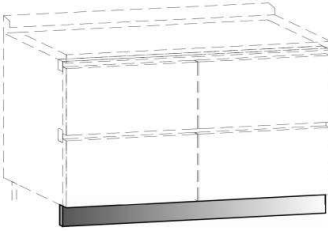
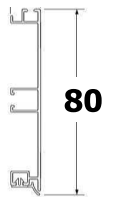
Elemento Unit	Finitura Finish	Dimensioni Dimension	Codice Code	Prezzo Price	
	<ul style="list-style-type: none"> PROFILO GOLA PIATTA ORIZZONTALE SUPERIORE Prezzo al metro lineare. Minimo conteggiabile 1m UPPER FLAT HORIZONTAL GROOVE Price per linear metre. Min. amount 1m 	 			
	Finitura epossidica Antracite / Epoxy finish Antracite		57 X 26mm	Lungh./Lenght max. 4,2m	G022A 83
	Finitura epossidica Champagne / Epoxy finish Champagne		57 X 26mm	Lungh./Lenght max. 4,2m	G022C 83
	Alluminio anodizzato spazzolato / Brushed aluminum anodized	57 X 26mm	Lungh./Lenght max. 4,2m	G022AL 66	
	<ul style="list-style-type: none"> PROFILO GOLA PIATTA ORIZZONTALE INTERMEDIA Prezzo al metro lineare. Minimo conteggiabile 1m INTERMEDIATE FLAT HORIZONTAL GROOVE Price per linear metre. Min. amount 1m 	 			
	Finitura epossidica Antracite / Epoxy finish Antracite		72 X 26mm	Lungh./Lenght max. 4,2m	G023A 83
	Finitura epossidica Champagne / Epoxy finish Champagne		72 X 26mm	Lungh./Lenght max. 4,2m	G023C 83
	Alluminio anodizzato spazzolato / Brushed aluminum anodized	72 X 26mm	Lungh./Lenght max. 4,2m	G023AL 70	
	<ul style="list-style-type: none"> PROFILO GOLA PIATTA VERTICALE LATERALE Prezzo al metro lineare. Minimo conteggiabile 1m END FLAT VERTICAL GROOVE Price per linear metre. Min. amount 1m 	 			
	Finitura epossidica Antracite / Epoxy finish Antracite		48 X 30mm	Lungh./Lenght max. 4,7m	G020A 96
	Finitura epossidica Champagne / Epoxy finish Champagne		48 X 30mm	Lungh./Lenght max. 4,7m	G020C 96
	Alluminio anodizzato spazzolato / Brushed aluminum anodized	48 X 30mm	Lungh./Lenght max. 4,7m	G020AL 83	
	<ul style="list-style-type: none"> PROFILO GOLA PIATTA VERTICALE INTERMEDIA Prezzo al metro lineare. Minimo conteggiabile 1m INTERMEDIATE FLAT VERTICAL GROOVE Price per linear metre. Min. amount 1m 	 			
	Finitura epossidica Antracite / Epoxy finish Antracite		66 X 30mm	Lungh./Lenght max. 4,7m	G019A 99
	Finitura epossidica Champagne / Epoxy finish Champagne		66 X 30mm	Lungh./Lenght max. 4,7m	G019C 99
	Alluminio anodizzato spazzolato / Brushed aluminum anodized	66 X 30mm	Lungh./Lenght max. 4,7m	G019AL 86	

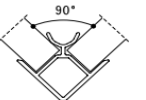
ZOCCOLI PLINTH

Elemento Unit	Finitura Finish	Dimensioni Dimension	Codice Code	Prezzo Price	
	<ul style="list-style-type: none"> ZOCCOLO H. 8 Prezzo al metro lineare. Minimo conteggiabile 1m PLINTH H.8 Price per linear metre. Min. amount 1m 	 			
	Zoccolo in Essenza / Plinth in essence		80 X 13mm	Lungh./Lenght max. 4 m	ZOC008E 63
	Zoccolo Finitura Resina / Plinth resin Finish		80 X 13mm	Lungh./Lenght max. 4 m	ZOC008R 76
	Zoccolo in Laminato Print/Polaris / Plinth in laminate Print/Polaris	80 X 13mm	Lungh./Lenght max. 4 m	ZOC008L 79	
	<ul style="list-style-type: none"> ZOCCOLO ALLUMINIO H. 8 Valore al metro lineare. Minimo conteggiabile 1m ALUMINIUM PLINTH H.8 Value per linear metre. Min. amount 1m 	 			
	Finitura epossidica Antracite / Epoxy finish Antracite		80 X 13mm	Lungh./Lenght max. 4 m	ZOC008A 56
	Finitura epossidica Champagne / Epoxy finish Champagne		80 X 13mm	Lungh./Lenght max. 4 m	ZOC008C 56
	Alluminio anodizzato spazzolato / Brushed aluminum anodized	80 X 13mm	Lungh./Lenght max. 4 m	ZOC008AL 40	
	<ul style="list-style-type: none"> ANGOLARE PER ZOCCOLO H. 8 CORNER FOR PLINTH H. 8 				
	Finitura epossidica Antracite / Epoxy finish Antracite		12 X 12 X 80 mm	ANG008A 27	
	Finitura epossidica Champagne / Epoxy finish Champagne		12 X 12 X 80 mm	ANG008C 27	
	Alluminio anodizzato spazzolato / Brushed aluminum anodized	12 X 12 X 80 mm	ANG008AL 24		
	<ul style="list-style-type: none"> GRIGLIA DI AEREAZIONE PER ZOCCOLO ALLUMINIO Premontata sul profilo zoccolo VENTILATION GRID FOR ALUMINIUM PLINTH Predisposed on the plinth profile 				
	Grigio /Grey		390 X 51mm	GRA008 40	



CAPPE PERSONALIZZATE
HOODS CUSTOM

CAPPE PERSONALIZZATE HOODS CUSTOM

• I prezzi NON comprendono maniglie, gole e zoccolo • Prices do NOT included the handles, the groove and the plinth

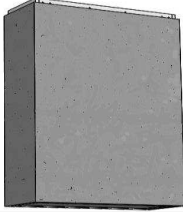
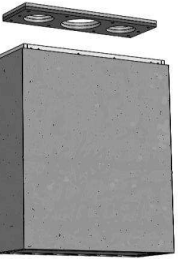
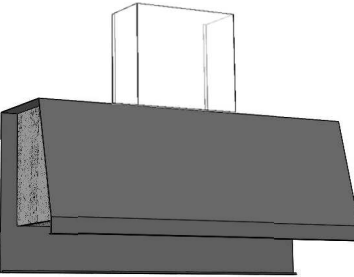
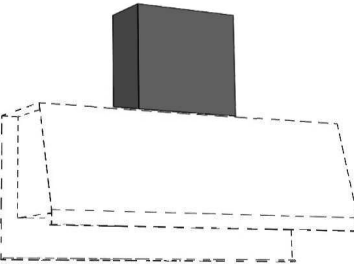

Elemento Unit	Finitura Finish	Dimensioni Dimension	Codice Code	Prezzo Price	
	<ul style="list-style-type: none"> • CAPPA "CUBE" A PARETE Box per aspiratore, altezza variabile a soffitto • WALL HOOD "CUBE" Box for aspirator, variable height ceilings 				
	Box in Essenza /Box in Essence	Da/From 60 a/to 95 Da/From 96 a/to 130	CA095CPE CA130CPE	853 1.021	
	Box Finitura Resina /Box Resin Finish	Da/From 60 a/to 95 Da/From 96 a/to 130	CA095CPR CA130CPR	718 860	
	Box in Laminato Print o Polaris /Box in Laminate Print or Polaris	Da/From 60 a/to 95 Da/From 96 a/to 130	CA095CPL CA130CPL	830 991	
		<ul style="list-style-type: none"> • CAPPA "CUBE" AD ISOLA Box per aspiratore, altezza variabile a soffitto • ISLAND HOOD "CUBE" Box for aspirator, variable height ceilings 			
		Box in Essenza /Box in Essence	Da/From 60 a/to 95 Da/From 96 a/to 130	CA095CIE CA130CIE	1.123 1.373
Box Finitura Resina /Box Resin Finish		Da/From 60 a/to 95 Da/From 96 a/to 130	CA095CIR CA130CIR	916 1.129	
Box in Laminato Print o Polaris /Box in Laminate Print or Polaris		Da/From 60 a/to 95 Da/From 96 a/to 130	CA095CIL CA130CIL	1.120 1.376	
		<ul style="list-style-type: none"> • CAPPA "FOGLIO" A PARETE Struttura cappa in ferro verniciato a polveri con box per inserimento aspiratore • WALL HOOD "FOGLIO" Structure in painted iron dust hood with box for inclusion aspirator 			
		Box in Essenza /Box in Essence	Larghezza/Width 90 Larghezza/Width 120 Larghezza/Width 150	CA090FE CA120FE CA150FE	1.080 1.208 1.347
	Box Finitura Resina /Box Resin Finish	Larghezza/Width 90 Larghezza/Width 120 Larghezza/Width 150	CA090FR CA120FR CA150FR	1.054 1.179 1.317	
	Box in Laminato Print o Polaris /Box in Laminate Print or Polaris	Larghezza/Width 90 Larghezza/Width 120 Larghezza/Width 150	CA090FL CA120FL CA150FL	1.050 1.176 1.311	
		<ul style="list-style-type: none"> • CAMINO PER CAPPA "FOGLIO" Copertura a "U" in ferro verniciato a polveri, profondità 25 • EXTENSION CORD FOR WALL HOOD "FOGLIO" Coverage to "U" in painted iron, depth 25 			
			Larghezza/Width 30 Larghezza/Width 45 Larghezza/Width 65	CA030C CA045C CA065C	139 165 182

CAPPE PERSONALIZZATE HOODS CUSTOM

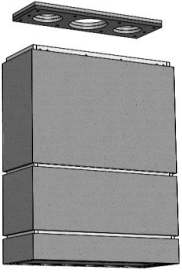
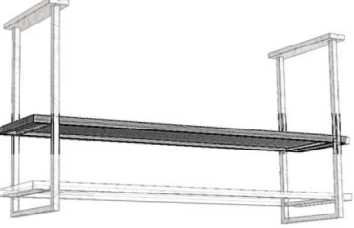
• I prezzi NON comprendono maniglie, gole e zoccolo • Prices do NOT included the handles, the groove and the plinth

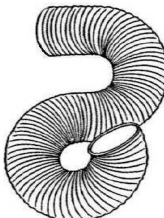

Elemento Unit	Finitura Finish	Dimensioni Dimension	Codice Code	Prezzo Price	
	<ul style="list-style-type: none"> • CAPPA "SOPPALCO" AD ISOLA Box per aspiratore predisposto inserimento mensole, altezza variabile • ISLAND HOOD "SOPPALCO" Box for aspirator suitable for inserting shelves, variable height ceilings 				
	Box in Essenza /Box in Essence	Da/From 60 a/to 95 Da/From 96 a/to 130	CA095SIE CA130SIE	1.232 1.482	
	Box Finitura Resina /Box Resin Finish	Da/From 60 a/to 95 Da/From 96 a/to 130	CA095SIR CA130SIR	1.037 1.261	
	Box in Laminato Print o Polaris /Box in Laminate Print or Polaris	Da/From 60 a/to 95 Da/From 96 a/to 130	CA095SIL CA130SIL	1.258 1.515	
		<ul style="list-style-type: none"> • TIRANTE A SOFFITTO "SOPPALCO" Struttura in ferro verniciato a polveri larg.50cm • CEILING SUPPORT "SOPPALCO" Powder coated steel structure width 50 cm 			
			Altezza/Height 105 Altezza/Height 135 Altezza/Height 165	CA105ST CA135ST CA165ST	626 659 695
		<ul style="list-style-type: none"> • MENSOLA PER INSERIMENTO CAPPA "SOPPALCO" Mensola con bordi per fissaggio a tiranti • SHELF FOR ENTRY HOOD "SOPPALCO" Shelf with edges for fixing with tie rods 			
			◇ Valore al metro lineare. Minimo conteggiabile 0,4 ml		
			◇ Value at linear meters. Countable minimum 0,4 meters		
		Mensola in Essenza /Shelf in Essence	Prof. 44 cm / Depth 44 cm	CA000SM	242
		<ul style="list-style-type: none"> • MENSOLA PER INSERIMENTO TIRANTE "SOPPALCO" Mensola con bordi per fissaggio a tiranti • SHELF FOR INCLUSION "SOPPALCO" Shelf with edges for fixing with tie rods 			
			◇ Valore al metro lineare. Minimo conteggiabile 0,4 ml		
		◇ Value at linear meters. Countable minimum 0,4 meters			
Mensola in Essenza /Shelf in Essence		Prof. 44 cm / Depth 44 cm	CA000M	219	

ASPIRATORE PER CAPPE VACUUM CLEANER FOR HOODS

Elemento Unit	Finitura Finish	Dimensioni Dimension	Codice Code	Prezzo Price
 <ul style="list-style-type: none"> ● ASPIRATORE INCASSO "MOVE" Vetro Nero e Potenza di aspirazione 800 mc/h ● HOOD BUILT "MOVE" Glass Black and Suction power 800 mc/h 		Larghezza/Width 60 cm	A060MOV	1.235
		Larghezza/Width 90 cm	A090MOV	1.301
		Larghezza/Width 120 cm	A120MOV	1.429
		◇ Filtro carbone zeolite/Carbon filter zeolite	MOVFILTRO	152
		◇ Camino telescopico Opzionale Telescopic fireplace optional	MOVCAMINO	79
 <ul style="list-style-type: none"> ● ASPIRATORE INCASSO "VIRGOLA" Potenza di aspirazione 600 mc/h ● HOOD BUILT "VIRGOLA" Suction power 600 mc/h 		Larghezza/Width 60 cm	A060VIR	731
		Larghezza/Width 90 cm	A090VIR	771
		Larghezza/Width 120 cm	A120VIR	846
 <ul style="list-style-type: none"> ● ASPIRATORE "GRUPPO INCASSO" Potenza di aspirazione 800 mc/h ● HOOD BUILT "GRUPPO INCASSO" Suction power 800 mc/h 		Larghezza/Width 50 cm	A050INC	708
		Larghezza/Width 70 cm	A070INC	744
		Larghezza/Width 105 cm	A105INC	873
		◇ Telecomando opzionale Optional remote control	TELINC	112
 <ul style="list-style-type: none"> ● TUBO FLESSIBILE PER ASPIRATORE In alluminio estensibile da 85 cm a 300 cm ● HOSE FOR CACUUM CLEANER In aluminum exendable from 85 cm to 300 cm 		Tubo da 130 cm/ Tube from 130 cm	A130FLES	60
		Tubo da 150 cm/ Tube from 130 cm	A150FLES	70

ELEMENTI COMPLEMENTARI COMPLEMENTARY ELEMENTS

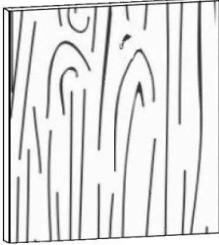
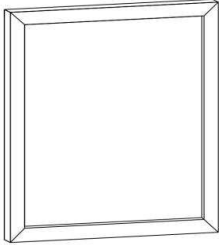
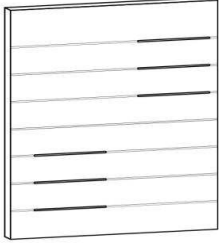
PANNELLI PANELS

Elemento Unit	Finitura Finish	Dimensioni Dimension	Codice Code	Prezzo Price
<ul style="list-style-type: none"> ● PANNELLO LISCIO ● PANEL SMOOTH 				
	Pannello in Essenza /Panel in Essence	Prezzo al mq /Price at square meters	PA000LE	282
	Pannello in 1° Patina Abete /Panel in Fir Old Wood	Prezzo al mq /Price at square meters	PA000LP	530
	Pannello Laminato Print Fin.Sei /Panel in Laminate Print Fin.Sei	Prezzo al mq /Price at square meters	PA000LLS	293
	Pannello Laminato Polaris Fin.Polaris /Panel in Laminate Fin.Polaris	Prezzo al mq /Price at square meters	PA000LLP	333
<ul style="list-style-type: none"> ● PANNELLO IN ESSENZA RIQUADRATO ● PANEL IN ESSENCE SQUARED 				
	Pannello in Essenza /Panel in Essence	Prezzo al mq /Price at square meters	PR000LE	325
	<ul style="list-style-type: none"> ● PANNELLO IN ESSENZA CON EFFETTO TAVOLE ● PANEL IN ESSENCE WITH EFFECT TABLES 			
	Pannello spessore 18 mm effetto tavole (I tagli per le lamine in ferro si eseguono ove indicato dal cliente)			
	Panel thickness 18 mm planks effect (The cuts for iron sheets are performed if indicated by the customer)			
	Pannello in Essenza /Panel in Essence	Prezzo al mq /Price at square meters	PP000LE	376
	Pannello in 1° Patina Abete /Panel in Fir Old Wood	Prezzo al mq /Price at square meters	PP000LP	448
Pannello Laminato Print Fin.Sei /Panel in Laminate Print Fin.Sei	Prezzo al mq /Price at square meters	PP000LLS	392	
Pannello Laminato Polaris Fin.Polaris /Panel in Laminate Fin.Polaris	Prezzo al mq /Price at square meters	PP000LLP	419	
<ul style="list-style-type: none"> ● MENSOLA IN METALLO PER PANNELLO A PARETE ● METAL SHELF FOR MODUL WITH BEADS 				
Finitura epossidica /Epoxy finish				
	Lungh. /Lenght 30 cm x prof. /depth 27 cm		LA030	79
	Lungh. /Lenght 50 cm x prof. /depth 27 cm		LA050	112
	Lungh. /Lenght 70 cm x prof. /depth 27 cm		LA070	135

MODULI DA INSERIRE SU COLONNE FORMS TO BE INCLUDED ON TALL UNITS

Prof.
Depth **40**

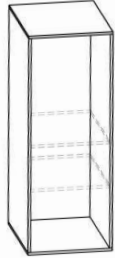
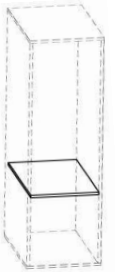
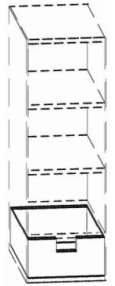
Elemento Unit	Finitura Finish	Dimensioni Dimension	Codice Code	Prezzo Price
<ul style="list-style-type: none"> ● ELEMENTO A GIORNO PER INSERIMENTO SU COLONNE ● ELEMENT OF A DAY FOR INCLUSION ON TALL UNITS 				
	Essenza /Essence	Da/From 20 a/to 40	EG040E	468
	Valchromat /Valchromat	Da/From 20 a/to 40	EG040V	251
	Paperstone Nero Slate /Paperstone Black Slate	Da/From 20 a/to 40	EG040P	919
<ul style="list-style-type: none"> ● DIVISORIO PER ELEMENTO A GIORNO ● DIVIDING FOR ELEMENT 				
	Essenza /Essence	Da/From 20 a/to 40	ED040E	60
	Valchromat /Valchromat	Da/From 20 a/to 40	ED040V	33
	Paperstone Nero Slate /Paperstone Black Slate	Da/From 20 a/to 40	ED040P	103
<ul style="list-style-type: none"> ● CASSETTO PER ELEMENTO A GIORNO ● DRAWER FOR ELEMENT A DAY 				
	Essenza /Essence	Altezza /Height 22 cm	EC040AE	149
		Altezza /Height 15 cm	EC040BE	135
		Altezza /Height 10 cm	EC040CE	126
	Valchromat /Valchromat	Altezza /Height 22 cm	EC040AV	109
		Altezza /Height 15 cm	EC040BV	99
		Altezza /Height 10 cm	EC040CV	89
	Paperstone Nero Slate /Paperstone Black Slate	Altezza /Height 22 cm	EC040AP	274
		Altezza /Height 15 cm	EC040BP	234
		Altezza /Height 10 cm	EC040CP	205

MODULI SERIE "SOPRAPIANO"
MODULES SIERES "SOPRAPIANO"

Prof. Depth 20

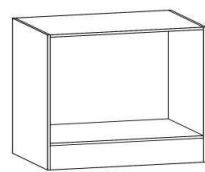
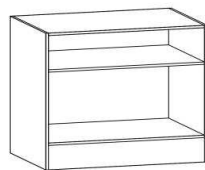
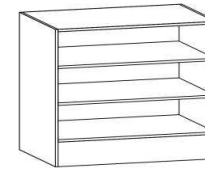
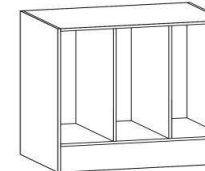
Elemento Unit	Finitura Finish	Dimensioni Dimension	Codice Code	Prezzo Price
<ul style="list-style-type: none"> ● MODULO SOPRAPIANO ● MODULE "SOPRAPIANO" 				
	◇ Elemento con schiena con 1 piano fisso orizzontale ◇ Element with your back with 1 fixed horizontal plane			
	Essenza /Essence	Da/From 46 a/to 65	SP065AE	287
		Da/From 66 a/to 95	SP095AE	353
		Da/From 96 a/to 130	SP130AE	425
	Valchromat /Valchromat	Da/From 46 a/to 65	SP065AV	175
		Da/From 66 a/to 95	SP095AV	208
		Da/From 96 a/to 130	SP130AV	247
	Paperstone Nero Slate /Paperstone Black Slate	Da/From 46 a/to 65	SP065AP	527
		Da/From 66 a/to 95	SP095AP	682
	Da/From 96 a/to 130	SP130AP	860	
<ul style="list-style-type: none"> ● MODULO SOPRAPIANO ● MODULE "SOPRAPIANO" 				
	◇ Elemento con schiena con 2 piani fissi orizzontali ◇ Element with your back with 2 fixed horizontal planes			
	Essenza /Essence	Da/From 46 a/to 65	SP065BE	316
		Da/From 66 a/to 95	SP095BE	389
		Da/From 96 a/to 130	SP130BE	474
	Valchromat /Valchromat	Da/From 46 a/to 65	SP065BV	191
		Da/From 66 a/to 95	SP095BV	231
		Da/From 96 a/to 130	SP130BV	274
	Paperstone Nero Slate /Paperstone Black Slate	Da/From 46 a/to 65	SP065BP	593
		Da/From 66 a/to 95	SP095BP	774
	Da/From 96 a/to 130	SP130BP	985	
<ul style="list-style-type: none"> ● MODULO SOPRAPIANO ● MODULE "SOPRAPIANO" 				
	◇ Elemento con schiena con 3 piani fissi orizzontali ◇ Element with your back with 3 fixed horizontal planes			
	Essenza /Essence	Da/From 46 a/to 65	SP065CE	346
		Da/From 66 a/to 95	SP095CE	412
		Da/From 96 a/to 130	SP130CE	484
	Valchromat /Valchromat	Da/From 46 a/to 65	SP065CV	208
		Da/From 66 a/to 95	SP095CV	251
		Da/From 96 a/to 130	SP130CV	303
	Paperstone Nero Slate /Paperstone Black Slate	Da/From 46 a/to 65	SP065CP	659
		Da/From 66 a/to 95	SP095CP	866
	Da/From 96 a/to 130	SP130CP	1.110	
<ul style="list-style-type: none"> ● MODULO SOPRAPIANO ● MODULE "SOPRAPIANO" 				
	◇ Elemento con schiena con 1 piano fisso orizzontale e 3 piani fissi verticali ◇ Element with your back with 1 fixed horizontal plane and 3 vertical fixed planes			
	Essenza /Essence	Da/From 46 a/to 65	SP065DE	346
		Da/From 66 a/to 95	SP095DE	412
		Da/From 96 a/to 130	SP130DE	484
	Valchromat /Valchromat	Da/From 46 a/to 65	SP065DV	214
		Da/From 66 a/to 95	SP095DV	247
		Da/From 96 a/to 130	SP130DV	287
	Paperstone Nero Slate /Paperstone Black Slate	Da/From 46 a/to 65	SP065DP	652
		Da/From 66 a/to 95	SP095DP	807
	Da/From 96 a/to 130	SP130DP	988	



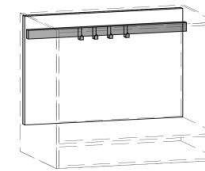
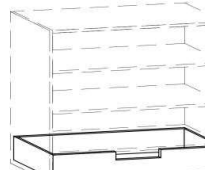
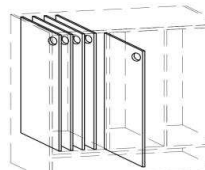
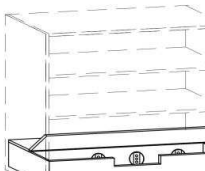

OPZIONI PER MODULI "SOPRAPIANO"
OPTIONS FOR MODULE "SOPRAPIANO"

Prof. Depth 20



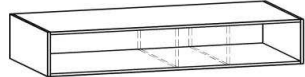

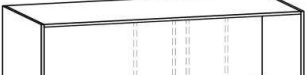
Elemento Unit	Finitura Finish	Dimensioni Dimension	Codice Code	Prezzo Price	
<ul style="list-style-type: none"> ● BARRA PORTAMESTOLI PER ELEMENTO "SOPRAPIANO" ● BAR HOLDER FOR ELEMENT "SOPRAPIANO" 					
	Finitura Nero Opaco /Matt Black Finish	Da/From 46 a/to 65	SP065N	119	
		Da/From 66 a/to 95	SP095N	132	
		Da/From 96 a/to 130	SP130N	165	
	Finitura Acciaio Inox /Stainless Steel Finish	Da/From 46 a/to 65	SP065A	139	
		Da/From 66 a/to 95	SP095A	162	
		Da/From 96 a/to 130	SP130A	198	
<ul style="list-style-type: none"> ● MODULO CASSETTO PER ELEMENTO "SOPRAPIANO" ● MODULE DRAWER FOR ELEMENT "SOPRAPIANO" 					
	Essenza /Essence	Da/From 46 a/to 65	SP065CAE	145	
		Da/From 66 a/to 95	SP095CAE	175	
	Valchromat /Valchromat	Da/From 46 a/to 65	SP065CAV	86	
		Da/From 66 a/to 95	SP095CAV	106	
	Paperstone Nero Slate /Paperstone Black Slate	Da/From 46 a/to 65	SP065CAP	185	
		Da/From 66 a/to 95	SP095CAP	241	
	<ul style="list-style-type: none"> ● MODULO SET 5 TAGLIERI PER ELEMENTO SOPRAPIANO ● MODULE SET 5 CUTTING BOARDS FOR ELEMENT 				
		Paperstone Nero Slate /Paperstone Black Slate	Dimensione /Dimension 110 x 183 x H. 440 mm	SP000P	376
<ul style="list-style-type: none"> ● MODULO CON PRESE ELETTRICHE PER ELEMENTO "SOPRAPIANO" ● MODULE WITH ELECTRICAL OUTLETS FOR ELEMENT "SOPRAPIANO" 					
	Essenza /Essence	Da/From 46 a/to 65	SP065EE	498	
		Da/From 66 a/to 95	SP095EE	629	
	Valchromat /Valchromat	Da/From 46 a/to 65	SP065EV	425	
		Da/From 66 a/to 95	SP095EV	537	
	Paperstone Nero Slate /Paperstone Black Slate	Da/From 46 a/to 65	SP065EP	600	
		Da/From 66 a/to 95	SP095EP	790	

MODULI "SOTTOPENSILE" MODULES "SOTTOPENSILE"



Prof. **20**
Depth

Elemento Unit	Finitura Finish	Dimensioni Dimension	Codice Code	Prezzo Price
<ul style="list-style-type: none"> • MODULO "SOTTOPENSILE" A GIORNO H 17 CM • MODULES "SOTTOPENSILE" A DAY HEIGHT 17 CM 				
	Essenza /Essence	Da/From 46 a/to 65	ST065AE	247
		Da/From 66 a/to 95	ST095AE	287
		Da/From 96 a/to 130	ST130AE	330
	Valchromat /Valchromat	Da/From 46 a/to 65	ST065AV	175
		Da/From 66 a/to 95	ST095AV	198
		Da/From 96 a/to 130	ST130AV	228
	Paperstone Nero Slate /Paperstone Black Slate	Da/From 46 a/to 65	ST065AP	346
		Da/From 66 a/to 95	ST095AP	435
		Da/From 96 a/to 130	ST130AP	537
<ul style="list-style-type: none"> • MODULO "SOTTOPENSILE" A GIORNO H 25 CM • MODULES "SOTTOPENSILE" A DAY HEIGHT 25 CM 				
	Essenza /Essence	Da/From 46 a/to 65	ST065BE	261
		Da/From 66 a/to 95	ST095BE	307
		Da/From 96 a/to 130	ST130BE	356
	Valchromat /Valchromat	Da/From 46 a/to 65	ST065BV	182
		Da/From 66 a/to 95	ST095BV	208
		Da/From 96 a/to 130	ST130BV	237
	Paperstone Nero Slate /Paperstone Black Slate	Da/From 46 a/to 65	ST065BP	386
		Da/From 66 a/to 95	ST095BP	484
		Da/From 96 a/to 130	ST130BP	600
<ul style="list-style-type: none"> • MODULO "SOTTOPENSILE" A GIORNO H 33 CM • MODULES "SOTTOPENSILE" A DAY HEIGHT 33 CM 				
	Essenza /Essence	Da/From 46 a/to 65	ST065CE	277
		Da/From 66 a/to 95	ST095CE	323
		Da/From 96 a/to 130	ST130CE	379
	Valchromat /Valchromat	Da/From 46 a/to 65	ST065CV	191
		Da/From 66 a/to 95	ST095CV	218
		Da/From 96 a/to 130	ST130CV	251
	Paperstone Nero Slate /Paperstone Black Slate	Da/From 46 a/to 65	ST065CP	425
		Da/From 66 a/to 95	ST095CP	537
		Da/From 96 a/to 130	ST130CP	662
<ul style="list-style-type: none"> • DIVISORIO PER MODULI "SOTTOPENSILE" • DIVIDING FOR MODULES "SOTTOPENSILE" 				
	Essenza /Essence		ST000DE	43
	Valchromat /Valchromat		ST000DV	37
	Paperstone Nero Slate /Paperstone Black Slate		ST000DP	63



BARRA SOTTOPENSILE ROD UNDER WALL UNITS

Elemento Unit	Finitura Finish	Dimensioni Dimension	Codice Code	Prezzo Price
<ul style="list-style-type: none"> • BARRA SOTTOPENSILE COMPLETA DI KIT FISSAGGIO • ROD UNDER WALL UNITS FIXING KIT COMPLETE 				
	Finitura Nero Opaco /Matt Black Finish	Lungh/Lenght 60 cm	BS060N	116
		Lungh/Lenght 90 cm	BS090N	129
		Lungh/Lenght 120 cm	BS120N	165
	Finitura Acciaio Inox /Stainless steel finish	Lungh/Lenght 180 cm	BS180N	228
		Lungh/Lenght 60 cm	BS060A	135
		Lungh/Lenght 90 cm	BS090A	158
<ul style="list-style-type: none"> • BARRA SOTTOPENSILE COMPLETA DI KIT FISSAGGIO • ROD UNDER WALL UNITS FIXING KIT COMPLETE 				
	Finitura Acciaio Inox /Stainless steel finish	Lungh/Lenght 120 cm	BS120A	198
		Lungh/Lenght 180 cm	BS180A	287
<ul style="list-style-type: none"> • MENSOLA PER BARRA SOTTOPENSILE • SHELF FOR ROD UNDER WALL UNITS 				
	Finitura Nero Opaco /Matt Black Finish	L./Lenght 30cm x P./Depth 17 x H./Height 5,5	BS030NM	152
		L./Lenght 60cm x P./Depth 17 x H./Height 5,5	BS060NM	165
		L./Lenght 30cm x P./Depth 17 x H./Height 5,5	BS030AM	182
	Finitura Acciaio Inox /Stainless steel finish	L./Lenght 60cm x P./Depth 17 x H./Height 5,5	BS060AM	201
<ul style="list-style-type: none"> • VASI PER BARRA SOTTOPENSILE • TANKS FOR ROD UNDER WALL UNITS 				
	Finitura Nero Opaco /Matt Black Finish	L./Lenght 5cm x P./Depth 5 x H./Height 5	BS005NV	60
		L./Lenght 9,5cm x P./Depth 9,5 x H./Height 9,5	BS009NV	50
		L./Lenght 5cm x P./Depth 5 x H./Height 5	BS005AV	60
	Finitura Acciaio Inox /Stainless steel finish	L./Lenght 9,5cm x P./Depth 9,5 x H./Height 9,5	BS009AV	50
<ul style="list-style-type: none"> • PORTAROTOLO PER BARRA SOTTOPENSILE • ROLL HOLDER FOR ROD UNDER WALL UNITS 				
	Finitura Nero Opaco /Matt Black Finish	L./Lenght 30cm x P./depth 17 x H./height 5,5	BS030NR	103
	Finitura Acciaio Inox /Stainless steel finish	L./Lenght 30cm x P./depth 17 x H./height 5,5	BS030AR	126





PROGRAMMA "I BANCHI" PROGRAM "I BANCHI"

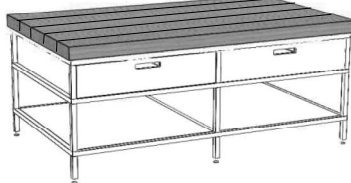

Elemento Unit	Finitura Finish	Dimensioni Dimension	Codice Code	Prezzo Price
<ul style="list-style-type: none"> ● "BANCO" IN FERRO CON CASSETTO Struttura in ferro verniciato a polveri completo di struttura in essenza o laccata con cassetto in legno e piano inferiore con tavole 				
<ul style="list-style-type: none"> ● "BANK" IRON WITH DRAWER Powder coating iron structure with drawer and lower table 				
		Dimensioni /Dimension 90 x 65 x h.81cm Dimensioni /Dimension 120 x 65 x h.81cm	BAN090 BAN120	1.952 2.203
<ul style="list-style-type: none"> ● "BANCO" IN FERRO CON CASSETTI Struttura in ferro verniciato a polveri completo di struttura in essenza o laccata con 2 cassetti in legno e piano inferiore con tavole 				
<ul style="list-style-type: none"> ● "BANK" IRON WITH DRAWERS Powder coating iron structure with two drawers and lower table 				
		Dimensioni /Dimension 180 x 65 x h.81cm Dimensioni /Dimension 240 x 65 x h.81cm	BAN180A BAN240A	3.341 3.911
<ul style="list-style-type: none"> ● "BANCO" IN FERRO CON CASSETTI Struttura in ferro verniciato a polveri completo di struttura in essenza o laccata con 4 cassetti in legno e piano inferiore con tavole 				
<ul style="list-style-type: none"> ● "BANK" IRON WITH DRAWERS Powder coating iron structure with four drawers and lower table 				
		Dimensioni /Dimension 180 x 105 x h.81cm Dimensioni /Dimension 240 x 105 x h.81cm	BAN180B BAN240B	4.530 5.014
<ul style="list-style-type: none"> ● "BANCO" IN FERRO PER FORNI Struttura in ferro verniciato a polveri completo di scatola lato forni+scatola a giorno con cassettoni+piano inferiore con tavole. Top non compreso nel prezzo 				
<ul style="list-style-type: none"> ● "BANK" IRON WITH DRAWERS Powder coating iron structure full of dust side box ovens+box per day with drawers+downstairs with tables. Excluding price top 				
		Dimensioni /Dimension 96 x 65 x h.149cm	BAN096F	2.435

TOP TOP

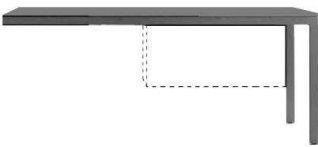
Elemento Unit	Finitura Finish	Dimensioni Dimension	Codice Code	Prezzo Price
<ul style="list-style-type: none"> ● TOP IN ESSENZA SPESSORE 2 CM Top lastronato 				
<ul style="list-style-type: none"> ◇ Minimo conteggiabile 0,4 mq 				
<ul style="list-style-type: none"> ● TOP IN ESSENCE THICKNESS 2 CM Top veneered 				
<ul style="list-style-type: none"> ◇ Countable minimum 0,4 Square meters 				
	Top in Essenza /Top in Essence Top in 1° Patina Abete /Top in Fir Old Wood Top in Laminato Print Fin.Sei /Top in Laminate Print Fin.Sei Top in Laminato Polaris Fin.Polaris /Top in Laminate Polaris Fin.Polar	Prezzo al mq /Price at square meters Prezzo al mq /Price at square meters Prezzo al mq /Price at square meters Prezzo al mq /Price at square meters	T002E T0021P T002LS T002LP	348 608 361 395
<ul style="list-style-type: none"> ● TOP IN ESSENZA SPESSORE 4 CM Top lastronato 				
<ul style="list-style-type: none"> ◇ Minimo conteggiabile 0,4 mq 				
<ul style="list-style-type: none"> ● TOP IN ESSENCE THICKNESS 4 CM Top veneered 				
<ul style="list-style-type: none"> ◇ Countable minimum 0,4 Square meters 				
	Top in Essenza /Top in Essence Top in 1° Patina Abete /Top in Fir Old Wood Top in Laminato Print Fin.Sei /Top in Laminate Print Fin.Sei Top in Laminato Polaris Fin.Polaris /Top in Laminate Polaris Fin.Polar	Prezzo al mq /Price at square meters Prezzo al mq /Price at square meters Prezzo al mq /Price at square meters Prezzo al mq /Price at square meters	T004E T0041P T004LS T004LP	392 721 397 425
<ul style="list-style-type: none"> ● TOP IN ESSENZA SPESSORE 4 CM Effetto Tavola (Massello) 				
<ul style="list-style-type: none"> ◇ Minimo conteggiabile 0,4 mq 				
<ul style="list-style-type: none"> ● TOP IN ESSENCE THICKNESS 4 CM Table Effect (solid) 				
<ul style="list-style-type: none"> ◇ Countable minimum 0,4 Square meters 				
	Top in Essenza /Top in Essence	Prezzo al mq /Price at square meters	T004M	562
<ul style="list-style-type: none"> ● TOP IN ESSENZA SPESSORE 6 CM Effetto Tavola (Massello) 				
<ul style="list-style-type: none"> ◇ Minimo conteggiabile 0,4 mq 				
<ul style="list-style-type: none"> ● TOP IN ESSENCE THICKNESS 4 CM Table Effect (solid) 				
<ul style="list-style-type: none"> ◇ Countable minimum 0,4 Square meters 				
	Top in Essenza /Top in Essence	Prezzo al mq /Price at square meters	T006M	611

PENISOLA PENINSULA

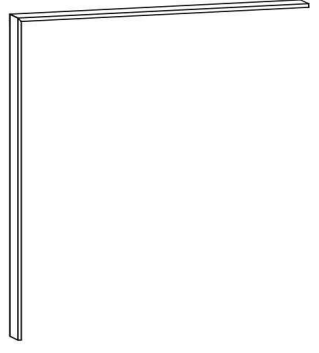
Elemento Unit	Finitura Finish	Dimensioni Dimension	Codice Code	Prezzo Price
	<ul style="list-style-type: none"> ● PIANO PENISOLA IN ESSENZA "OSLO" Piano intelaiato spessore 4 cm in massello lastronato 	◇ Valore al metro quadro. Minimo conteggiabile 1 mq	T004OSL	906
	<ul style="list-style-type: none"> ● PLAN PENINSULA IN ESSENCE "OSLO" Plan framed 4 cm thick solid slab 	◇ Value at linear meters. Countable minimum 1 square meters		
Top in Essenza /Top in Essence				
	<ul style="list-style-type: none"> ● GAMBA DI SOSTEGNO PER PIANO "OSLO" Sostegno in metallo con piastra rivestito in legno 	Dimensioni / Dimensions 4 X 17 X 89 cm	G001OSL	261
	<ul style="list-style-type: none"> ● SUPPORT FOR LEG PLAN "OSLO" Metal support with plate covered with wood 			
	<ul style="list-style-type: none"> ● BANCO MULTIFUNZIONALE "BRIDGE" Struttura in metallo rivestita in legno 	Dimensioni / Dimensions 240 x 105 x 89 cm	G000BR	2.199
	<ul style="list-style-type: none"> ● BENCH MULTIFUNCTION "BRIDGE" Metal structure covered in wood 			
	<ul style="list-style-type: none"> ● ELEMENTO SOSPESO CON 1 CASSETTO + 1 CASSETTONE PER BANCO "BRIDGE" ● ELEMENT SUSPENDED WITH 1 DRAWER + 1 DEEP DRAWER FOR BANK "BRIDGE" 	Dimensioni / Dimension 920 X 660 X 485 mm	G000BRC	1.380

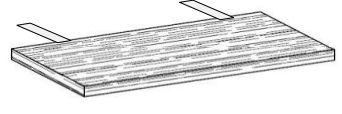
Elemento Unit	Finitura Finish	Dimensioni Dimension	Codice Code	Prezzo Price
	<ul style="list-style-type: none"> ● GAMBA DI SOSTEGNO "I BANCHI" Sostegno in metallo con piedini regolabili 	Dimensioni / Dimensions 3 x 40 x 89 cm	G000B	581
	<ul style="list-style-type: none"> ● LEG SUPPORT "I BANCHI" Metal support with adjustable feet 			
	<ul style="list-style-type: none"> ● COPRIFILI IN ESSENZA ● CASING IN ESSENCE 	◇ Valore al metro lineare. Minimo conteggiabile 1 ml ◇ Value at linear meters. Countable minimum 1 meters	COR004E	33
	<ul style="list-style-type: none"> ● MENSOLA IN ESSENZA SPESSORE 2,5 CM ● SHELF IN ESSENCE THICKNESS 2,5 CM 	◇ Valore al metro lineare. Minimo conteggiabile 0,4 ml ◇ Value at linear meters. Countable minimum 0,4 meters	M040E	168
	Mensola in Essenza /Shelf in Essence	Prof. 40 cm /Depth 20 cm		
	Mensola in 1° Patina Abete /Shelf in Fir Old Wood	Prof. 65 cm /Depth 30 cm		
	Mensola in Laminato Print Fin.Sei /Shelf in Laminate Print Fin.Sei	Prof. 40 cm /Depth 20 cm		
	Mensola in Laminato Polaris Fin.Polaris /Shelf in Laminate Fin.Polaris	Prof. 65 cm /Depth 30 cm		
	Mensola in Laminato Polaris Fin.Polaris /Shelf in Laminate Fin.Polaris	Prof. 40 cm /Depth 20 cm		
			M065E	251
			M040P	302
			M065P	448
			M040LS	185
			M065LS	256
			M040LP	203
			M065LP	289
	<ul style="list-style-type: none"> ● MENSOLA IN ESSENZA A PARETE SPESSORE 2,5 CM ● SHELF IN ESSENCE TO WALL THICKNESS 2,5 CM 	◇ Valore al metro lineare. Minimo conteggiabile 0,4 ml ◇ Value at linear meters. Countable minimum 0,4 meters	MP020E	137
	Mensola in Essenza /Shelf in Essence	Prof. 20 cm /Depth 20 cm		
	Mensola in 1° Patina Abete /Shelf in Fir Old Wood	Prof. 30 cm /Depth 30 cm		
	Mensola in Laminato Print Fin.Sei /Shelf in Laminate Print Fin.Sei	Prof. 20 cm /Depth 20 cm		
	Mensola in Laminato Polaris Fin.Polaris /Shelf in Laminate Fin.Polaris	Prof. 30 cm /Depth 30 cm		
	Mensola in Laminato Polaris Fin.Polaris /Shelf in Laminate Fin.Polaris	Prof. 20 cm /Depth 20 cm		
			MP030E	157
			MP020P	216
			MP030P	272
			MP020LS	154
			MP030LS	175
			MP020LP	158
			MP030LP	182

VASCHE/TOP/ALZATE IN MARMO SINK/TOP/RAISED IN MARBLE

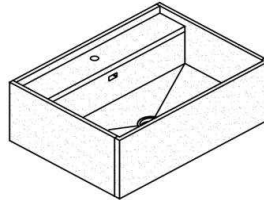
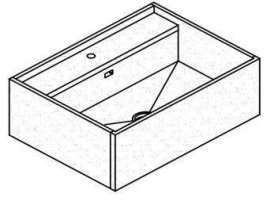
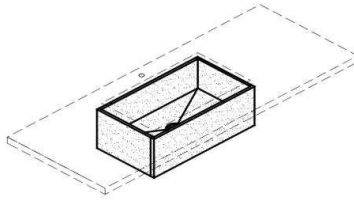
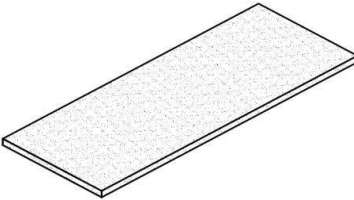
Elemento Unit	Finitura Finish	Dimensioni Dimension	Codice Code	Prezzo Price
	<ul style="list-style-type: none"> • VASCA "ACQUALTA 95" Vasca assemblata h 33 cm prof. 66 cm con fondo con pendenza Comprensivo di piletta basket acciaio e foro rubinetto • SINK "ACQUALTA 95" Sink assembled height 33 cm depth 66 cm with the bottom slope Including drain basket steel and tap hole 			
	Botticino pergamena fin.vintage/Botticino parchment fin.vintage	Largh./Width da/From 60 a/to 95	V095BO	2.757
	Bardiglio imperiale fin.vintage/Bardiglio imperial fin.vintage	Largh./Width da/From 60 a/to 95	V095BA	2.913
	Nero assoluto fiammato e spazzolato/Black pure flamed and brushed	Largh./Width da/From 60 a/to 95	V095NA	3.007
	Quarzite fin.k-proof/Quartzite fin.k-proof	Largh./Width da/From 60 a/to 95	V095QK	3.058
	Nero assoluto fin.work/Black Pure fin.work	Largh./Width da/From 60 a/to 95	V095NW	3.152
Pietra piacentina/Piasentina stone	Largh./Width da/From 60 a/to 95	V095PP	4.153	
	<ul style="list-style-type: none"> • VASCA "ACQUALTA 130" Vasca assemblata h 33 cm prof. 66 cm con fondo con pendenza Comprensivo di piletta Basket acciaio e foro rubinetto • SINK "ACQUALTA 130" Sink assembled height 33 cm depth 66 cm with the bottom slope Including drain basket steel and tap hole 			
	Botticino pergamena fin.vintage/Botticino parchment fin.vintage	Largh./Width da/From 96 a/to 130	V130BO	3.160
	Bardiglio imperiale fin.vintage/Bardiglio imperial fin.vintage	Largh./Width da/From 96 a/to 130	V130BA	3.190
	Nero assoluto fiammato e spazzolato/Black pure flamed and brushed	Largh./Width da/From 96 a/to 130	V130NA	3.313
	Quarzite fin.k-proof/Quartzite fin.k-proof	Largh./Width da/From 96 a/to 130	V130QK	3.355
	Nero assoluto fin.work/Black Pure fin.work	Largh./Width da/From 96 a/to 130	V130NW	3.475
Pietra piacentina/Piasentina stone	Largh./Width da/From 96 a/to 130	V130PP	4.493	
	<ul style="list-style-type: none"> • LAVELLO "SOTTOTOP" Vasca assemblata sotto top con fondo svasato per pendenza comprensivo di piletta basket acciaio e foro rubinetto • SINK UNDERMOUNT Bath assembled under top with flared bottom for slope Including drain Basket 9 cm steel and tap hole 			
	Botticino pergamena fin.vintage/Botticino parchment fin.vintage	Largh./Width da/From 60 a/to 95	LS095BO	1.877
	Bardiglio imperiale fin.vintage/Bardiglio imperial fin.vintage	Largh./Width da/From 60 a/to 95	LS095BA	1.939
	Nero assoluto fiammato e spazzolato/Black pure flamed and brushed	Largh./Width da/From 60 a/to 95	LS095NA	1.976
	Quarzite fin.k-proof/Quartzite fin.k-proof	Largh./Width da/From 60 a/to 95	LS095QK	1.997
	Nero assoluto fin.work/Black Pure fin.work	Largh./Width da/From 60 a/to 95	LS095NW	2.034
Pietra piacentina/Piasentina stone	Largh./Width da/From 60 a/to 95	LS095PP	2.431	
	<ul style="list-style-type: none"> • TOP SPESSORE 2 CM Prezzo al metro quadro Minimo conteggiabile 0,3 mq • TOP THICKNESS 2 CM Price for square metre Countable minimum 0,3 square meters 			
	Botticino pergamena fin.vintage/Botticino parchment fin.vintage	Lungh./Lenght max 2,8 m	T002BO	746
	Bardiglio imperiale fin.vintage/Bardiglio imperial fin.vintage	Lungh./Lenght max 2,8 m	T002BA	832
	Nero assoluto fiammato e spazzolato/Black pure flamed and brushed	Lungh./Lenght max 3,0 m	T002NA	883
	Quarzite fin.k-proof/Quartzite fin.k-proof	Lungh./Lenght max 2,8 m	T002QK	912
	Nero assoluto fin.work/Black Pure fin.work	Lungh./Lenght max 3,0 m	T002NW	963
Pietra piacentina/Piasentina stone	Lungh./Lenght max 2,0 m	T002PP	1.513	

VASCHE/TOP/ALZATE IN MARMO SINK/TOP/RAISED IN MARBLE

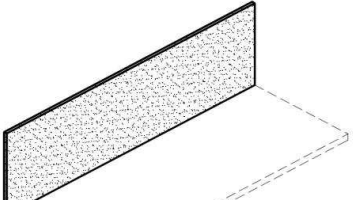

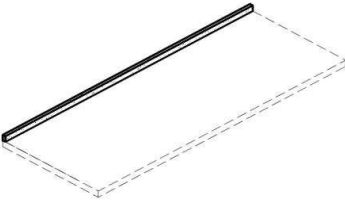
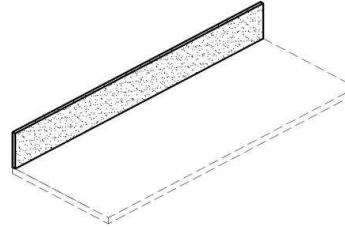
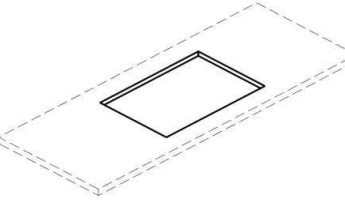
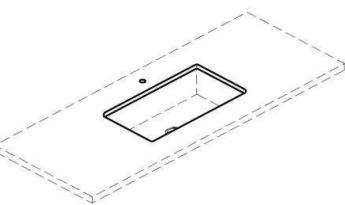

Elemento Unit	Finitura Finish	Dimensioni Dimension	Codice Code	Prezzo Price
	<ul style="list-style-type: none"> • TOP SPESSORE 3 CM Prezzo al metro quadro Minimo conteggiabile 0,3 mq • TOP THICKNESS 3 CM Price for square metre Countable minimum 0,3 square meters 			
	Botticino pergamena fin.vintage/Botticino parchment fin.vintage	Lungh./Lenght max 2,8 m		
	Bardiglio imperiale fin.vintage/Bardiglio imperial fin.vintage	Lungh./Lenght max 2,8 m	T003BO	818
	Nero assoluto fiammato e spazzolato/Black pure flamed and brushed	Lungh./Lenght max 3,0 m	T003BA	940
	Quarzite fin.k-proof/Quartzite fin.k-proof	Lungh./Lenght max 2,8 m	T003NA	1.101
	Nero assoluto fin.work/Black Pure fin.work	Lungh./Lenght max 3,0 m	T003NW	1.152
Pietra piacentina/Piasentina stone	Lungh./Lenght max 2,0 m	T003PP	2.237	
	<ul style="list-style-type: none"> • TOP SCATOLATO SPESSORE 6 CM Prezzo al metro quadro Minimo conteggiabile 0,5 mq • CANNED TOP THICKNESS 6 CM Price for square metre Countable minimum 0,5 square meters 			
	Botticino pergamena fin.vintage/Botticino parchment fin.vintage	Lungh./Lenght max 2,8 m		
	Bardiglio imperiale fin.vintage/Bardiglio imperial fin.vintage	Lungh./Lenght max 2,8 m	TS006BO	1.340
	Nero assoluto fiammato e spazzolato/Black pure flamed and brushed	Lungh./Lenght max 3,0 m	TS006BA	1.544
	Quarzite fin.k-proof/Quartzite fin.k-proof	Lungh./Lenght max 2,8 m	TS006NA	1.597
	Nero assoluto fin.work/Black Pure fin.work	Lungh./Lenght max 3,0 m	TS006QK	1.625
Pietra piacentina/Piasentina stone	Lungh./Lenght max 2,0 m	TS006NW	1.676	
		TS006PP	2.226	
	<ul style="list-style-type: none"> • TOP SCATOLATO SPESSORE 19,5 CM Prezzo al metro quadro Minimo conteggiabile 0,5 mq • CANNED TOP THICKNESS 19,5 CM Price for square metre Countable minimum 0,5 square meters 			
	Botticino pergamena fin.vintage/Botticino parchment fin.vintage	Lungh./Lenght max 2,8 m		
	Bardiglio imperiale fin.vintage/Bardiglio imperial fin.vintage	Lungh./Lenght max 2,8 m	TS020BO	1.712
	Nero assoluto fiammato e spazzolato/Black pure flamed and brushed	Lungh./Lenght max 3,0 m	TS020BA	1.844
	Quarzite fin.k-proof/Quartzite fin.k-proof	Lungh./Lenght max 2,8 m	TS020NA	1.919
	Nero assoluto fin.work/Black Pure fin.work	Lungh./Lenght max 3,0 m	TS020QK	1.962
Pietra piacentina/Piasentina stone	Lungh./Lenght max 2,0 m	TS020NW	2.041	
		TS020PP	2.864	
	<ul style="list-style-type: none"> • SCHIENALE SPESSORE 2 CM Prezzo al metro quadro Minimo conteggiabile 0,4 mq • BACK PANEL THICKNESS 2 CM Price for square metre Countable minimum 0,4 square meters 			
	Botticino pergamena fin.vintage/Botticino parchment fin.vintage	Lungh./Lenght max 2,8 m		
	Bardiglio imperiale fin.vintage/Bardiglio imperial fin.vintage	Lungh./Lenght max 2,8 m	S002BO	746
	Nero assoluto fiammato e spazzolato/Black pure flamed and brushed	Lungh./Lenght max 3,0 m	S002BA	832
	Quarzite fin.k-proof/Quartzite fin.k-proof	Lungh./Lenght max 2,8 m	S002NA	883
	Nero assoluto fin.work/Black Pure fin.work	Lungh./Lenght max 3,0 m	S002QK	912
Pietra piacentina/Piasentina stone	Lungh./Lenght max 2,0 m	S002NW	963	
		S002PP	1.513	

VASCHE/TOP/ALZATE IN MARMO SINK/TOP/RAISED IN MARBLE

Elemento Unit	Finitura Finish	Dimensioni Dimension	Codice Code	Prezzo Price
	<ul style="list-style-type: none"> ● ALZATINA SEZIONE 4 X 2 CM Prezzo al metro lineare Minimo conteggiabile 0,4 ml ● BACK-SPLASH SECTION 4 X 2 CM Price for linear metre Countable minimum 0,4 linear meters 			
	Botticino pergamena fin.vintage/Botticino parchment fin.vintage	Lungh./Lenght max 1,3 m	ALZ004BO	75
	Bardiglio imperiale fin.vintage/Bardiglio imperial fin.vintage	Lungh./Lenght max 1,3 m	ALZ004BA	75
	Nero assoluto fiammato e spazzolato/Black pure flamed and brushed	Lungh./Lenght max 1,3 m	ALZ004NA	73
	Quarzite fin.k-proof/Quartzite fin.k-proof	Lungh./Lenght max 1,3 m	ALZ004QK	73
	Nero assoluto fin.work/Black Pure fin.work	Lungh./Lenght max 1,3 m	ALZ004NW	73
	Pietra piacentina/Piasentina stone	Lungh./Lenght max 1,3 m	ALZ004PP	73
	<ul style="list-style-type: none"> ● ALZATINA SEZIONE 25 X 2 CM Prezzo al metro lineare Minimo conteggiabile 0,4 ml ● BACK-SPLASH SECTION 25 X 2 CM Price for linear metre Countable minimum 0,4 linear meters 			
	Botticino pergamena fin.vintage/Botticino parchment fin.vintage	Lungh./Lenght max 1,8 m	ALZ025BO	279
	Bardiglio imperiale fin.vintage/Bardiglio imperial fin.vintage	Lungh./Lenght max 1,8 m	ALZ025BA	300
	Nero assoluto fiammato e spazzolato/Black pure flamed and brushed	Lungh./Lenght max 1,8 m	ALZ025NA	313
	Quarzite fin.k-proof/Quartzite fin.k-proof	Lungh./Lenght max 1,8 m	ALZ025QK	320
	Nero assoluto fin.work/Black Pure fin.work	Lungh./Lenght max 1,8 m	ALZ025NW	333
	Pietra piacentina/Piasentina stone	Lungh./Lenght max 1,8 m	ALZ025PP	470
	<ul style="list-style-type: none"> ● FORO GREZZO Con barre di rinforzo in fiberglass sotto al piano ● UNIFISHED HOLES DRILLED ON MARBLE TOP With reinforcing bars in fiberglass under the plan 			
	Foro rettangolare grezzo/Unfinished rectangular hole		FG000R	261
	Foro angolare grezzo/Unfinished angular hole		FG000A	259
	Foro circolare grezzo/Unfinished circular hole		FG000C	108
	Foro con ribassamento per incasso filo top/Countersunk hole for recess flush with tap hole		FG000I	389
	<ul style="list-style-type: none"> ● FORO RIFINITO PER LAVELLO Con barre di rinforzo in fiberglass sotto al piano e foro rubinetto ● FINISHED HOLES DRILLED IN MARBLE TOP With reinforcing bars in fiberglass under the plan and hole for 			
	Foro rettangolare rifinito/Finished rectangular hole		FR000R	644
	Foro rifinito circolare/Finished circular hole		FR000C	192
	Lavorazione foro rifinito e scivolo rastremato sul lato destro o sinistro/Work for finished hole and smoth slide tapered right and left		FR000S	1.181





ACCESSORI INTERNI CABINETS ACCESSORIES

PATTUMIERE PER RACCOLTA DIFFERENZIATA SEPARATE WASTE COLLECTION SYSTEM

Elemento Unit	Finitura Finish	Dimensioni Dimension	Codice Code	Prezzo Price
	<ul style="list-style-type: none"> ● PATTUMIERA 2 CESTI PER BASE 60 Contenitori Grigio Orione con coperchi rivestiti in acciaio inox ● DUST-BIN 2 WASTE CONTAINER FOR BASE 60 Orion Grey waste with lids with satin stainless steel coatings 	L 540 X P 490 X H 295 mm	RAC060	145
	<ul style="list-style-type: none"> ● PATTUMIERA 3 CESTI PER BASE 90 Contenitori Grigio Orione con coperchi rivestiti in acciaio inox ● DUST-BIN 3 WASTE CONTAINER FOR BASE 90 Orion Grey waste with lids with satin stainless steel coatings 	L 840 X P 490 X H 295 mm	RAC090	175
	<ul style="list-style-type: none"> ● PATTUMIERA 4 CESTI PER BASE 120 Contenitori Grigio Orione con coperchi rivestiti in acciaio inox ● DUST-BIN 4 WASTE CONTAINER FOR BASE 120 Orion Grey waste with lids with satin stainless steel coatings 	L 840 X P 490 X H 295 mm	RAC120	228
	<ul style="list-style-type: none"> ● PATTUMIERA 3 CESTI PER BASE Coperchio e involucro in acciaio inox ● DUST-BIN 3 WASTE CONTAINER FOR BASE Stainless steel lid and outer body 	L 343 X P 475 X H 433 mm	RAC045A	155

PORTAPOSATE CUTLERY TRAY

Elemento Unit	Finitura Finish	Dimensioni Dimension	Codice Code	Prezzo Price
	<ul style="list-style-type: none"> ● PORTAPOSATE PER BASE 45 Colore Grigio Orione ● CUTLERY TRAY FOR BASE 45 Color Orion Grey 	L 368 X P 472 X H 45 mm	POR045	116
	<ul style="list-style-type: none"> ● PORTAPOSATE PER BASE 60 Colore Grigio Orione ● CUTLERY TRAY FOR BASE 60 Color Orion Grey 	L 518 X P 472 X H 45 mm	POR060	122
	<ul style="list-style-type: none"> ● PORTAPOSATE PER BASE 90 Colore Grigio Orione ● CUTLERY TRAY FOR BASE 90 Color Orion Grey 	L 818 X P 472 X H 45 mm	POR090	175
	<ul style="list-style-type: none"> ● PORTAPOSATE PER BASE 120 Colore Grigio Orione ● CUTLERY TRAY FOR BASE 120 Color Orion Grey 	L 1118 X P 472 X H 45 mm	POR120	214

Elemento Unit	Finitura Finish	Dimensioni Dimension	Codice Code	Prezzo Price
 <ul style="list-style-type: none"> ● FARETTO LED DA INCASSO Faretto 1,6 W 3000°K 12 V Colore Alluminio ● RECESSED LED SPOTLIGHTS Spotlight 1,6 W 3000°K 12 V Color Aluminum 		Diametro/Diameter 40 mm	FAR040	60
		Diametro/Diameter 55 mm	FAR055	60
 <ul style="list-style-type: none"> ● STRIP LED Striscia Led in gomma 4,4 W/m 3200°K 12 V ● STRIP LED Strip Led 4,4 W/m 3200°K 12 V 		Prezzo al m/Price at linear meter	LED000	60
 <ul style="list-style-type: none"> ● INTERRUTTORE A SFIORO ● TOUCH ON SWITCH 		100-240 V	INTSFI	63
 <ul style="list-style-type: none"> ● KIT ALIMENTAZIONE SPINA EUROPA 230 V 50 Hz out:12 V DC con distributore 6 vie ● EUROPE PLUG POWER SUPPLY KIT 230 V 50 Hz out:12 V DC 6 way distributor 		Alimentatore/Supply 15 W	TRA15	70
		Alimentatore/Supply 30 W	TRA30	89
		Alimentatore/Supply 75 W	TRA75	142

WALL

FRONTALI RESINATI CON PRODOTTI KERAKOLL - Spessore 23
FRONT WITH RESINATED KERAKOLL PRODUCTS - Thickness 23

FASCIA PREZZO ANTA DOOR PRICE RANGE

9

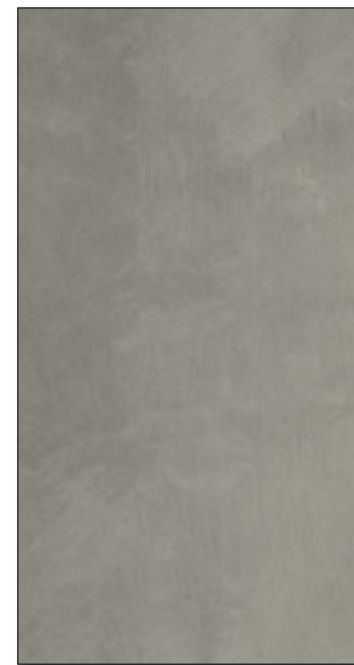

FASCIA PREZZO SKY-FLOOR SKY-FLOOR PRICE RANGE

2

2

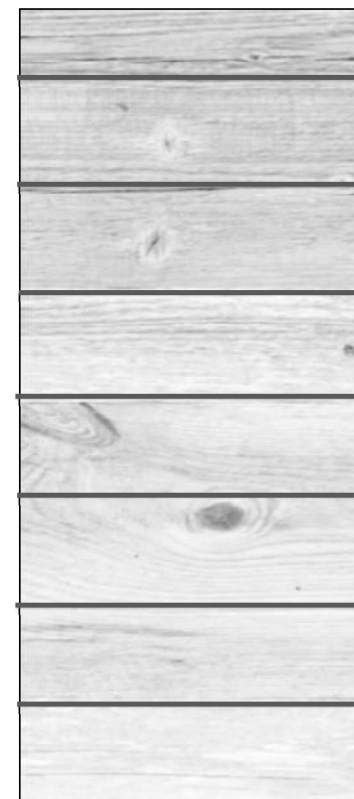

Colore naturale risultante dal processo di ossidazione degli agenti atmosferici+Protettivo all'acqua/Natural color oxidized weathering+Protective water

FRONTALI RESINATI CON PRODOTTI KERAKOLL - Spessore 23
FRONT WITH RESINATED KERAKOLL PRODUCTS - Thickness 23

MODULARITA' PROGRAMMA "WALL" MODULARITY "WALL" PROGRAM

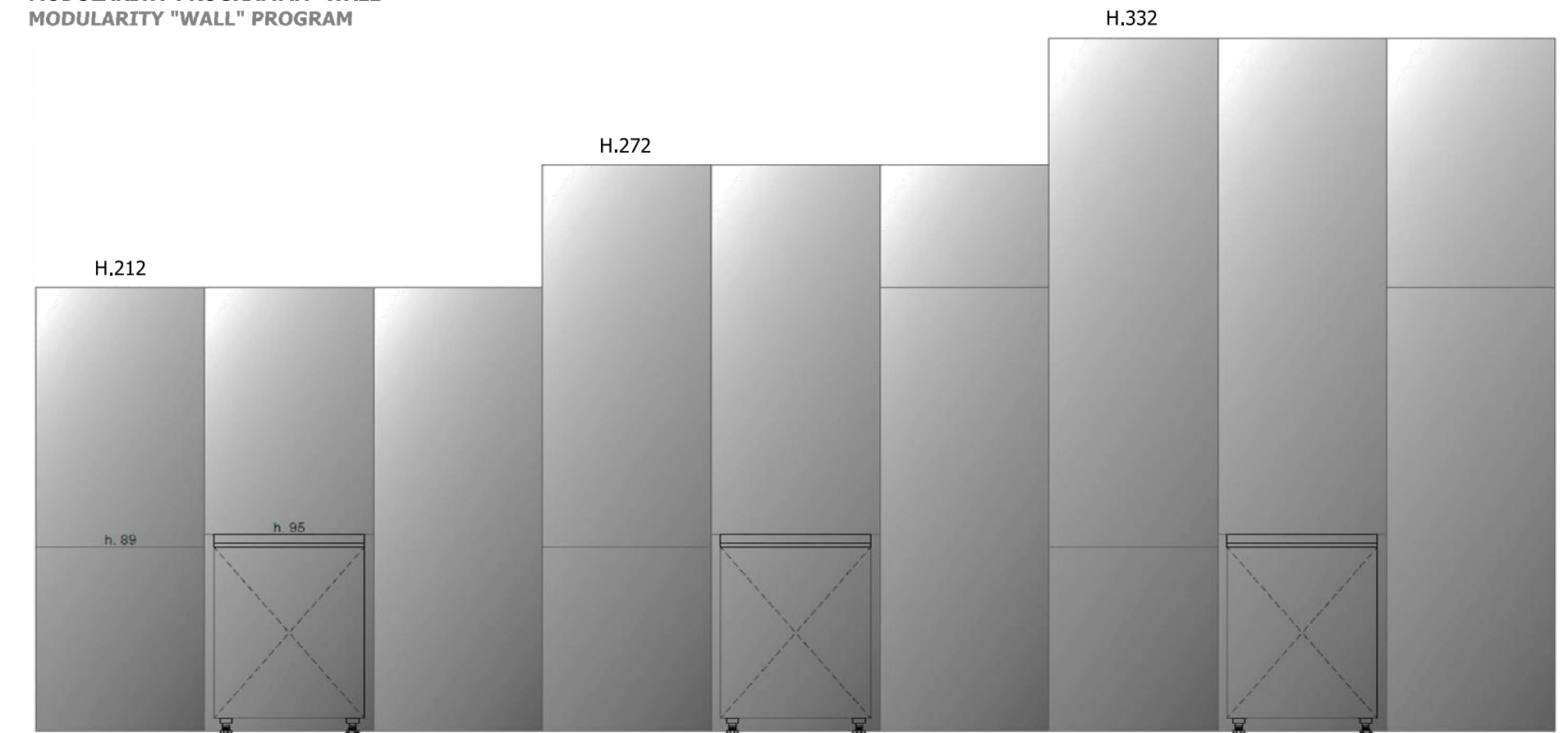

LARGHEZZE FUSTO PROGRAMMA "WALL" MODULARITY CARCASE "WALL" PROGRAM

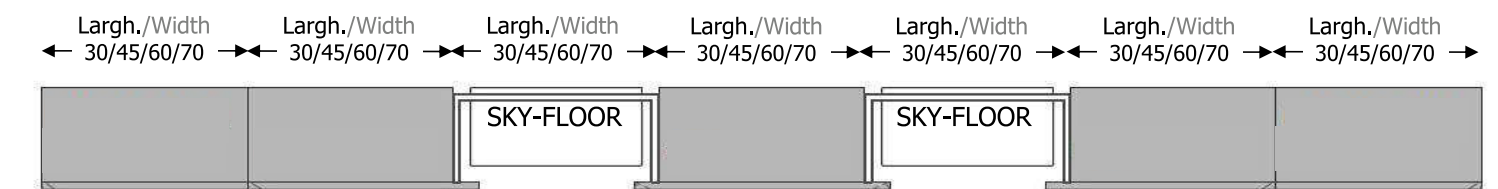

SCHEMA APERTURA ANTE SENZA MANIGLIA PROGRAMMA "WALL" SCHEDULE OPENING DOORS WITHOUT HANDLE PROGRAM "WALL" PROGRAM

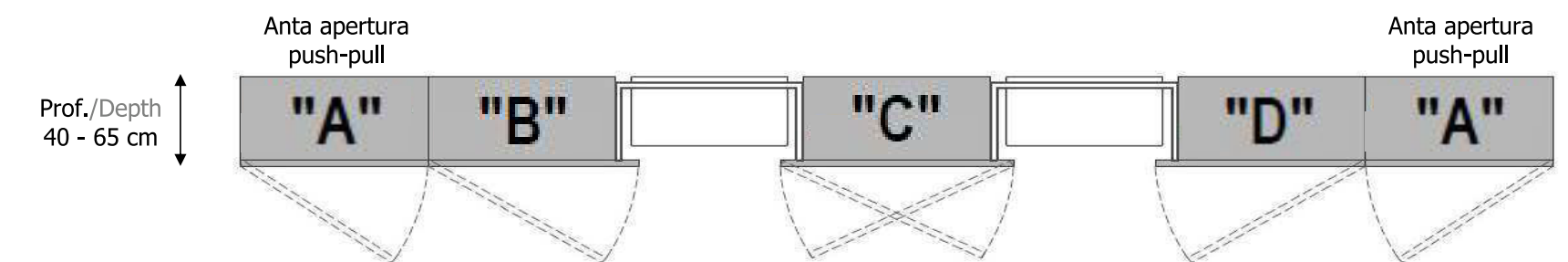

COLONNE DISPENSA WALL
TALL LARDER UNITS WALL

Prof. Depth **40**

Altezza Height **212**

Elemento Unit	Larghezza Width	Codice Code	1	2	3	4	5	6	7	8	9
---------------	-----------------	-------------	---	---	---	---	---	---	---	---	---

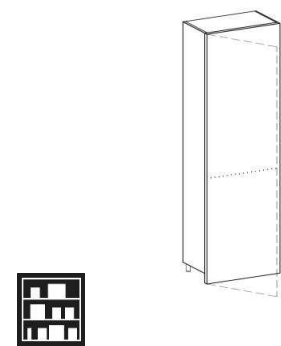

● **COLONNA 1/2 ANTE APERTURA PUSH PULL TIPO "A"**

Con cinque ripiani interni regolabili

- ◇ La colonna si può ridurre in altezza, senza maggiorazioni di prezzo fino a 149 cm
- ◇ La colonna si può ridurre in profondità, senza maggiorazioni di prezzo fino a 35cm
- ◇ L'apertura dell'anta può essere destra o sinistra

● **TALL UNIT 1/2 DOORS WITH OPENING PUSH PULL TYPE "A"**

With five internal adjustable shelves

- ◇ The tall unit can be reduced in height, without price surcharge up to 149 cm
- ◇ The tall unit can be reduced in depth, without price surcharge up to 35cm
- ◇ The opening of the door can be right or left

Fusto/Carcase 30 cm	W1030A	-	-	-	-	-	-	-	-	-	1.185
Fusto/Carcase 45 cm	W1045A	-	-	-	-	-	-	-	-	-	1.416
Fusto/Carcase 60 cm	W1060A	-	-	-	-	-	-	-	-	-	1.686
Fusto/Carcase 70 cm	W1070A	-	-	-	-	-	-	-	-	-	1.840

● **COLONNA 1/2 ANTE TIPO "B"**

Con cinque ripiani interni regolabili

- ◇ La colonna si può ridurre in altezza, senza maggiorazioni di prezzo fino a 149 cm
- ◇ La colonna si può ridurre in profondità, senza maggiorazioni di prezzo fino a 35cm
- ◇ L'apertura dell'anta è sinistra

● **TALL UNIT 1/2 DOORS TYPE "B"**

With five internal adjustable shelves

- ◇ The tall unit can be reduced in height, without price surcharge up to 149 cm
- ◇ The tall unit can be reduced in depth, without price surcharge up to 35cm
- ◇ The opening of the door is left

Fusto/Carcase 30 cm	W1030B	-	-	-	-	-	-	-	-	-	1.271
Fusto/Carcase 45 cm	W1045B	-	-	-	-	-	-	-	-	-	1.541
Fusto/Carcase 60 cm	W1060B	-	-	-	-	-	-	-	-	-	1.771
Fusto/Carcase 70 cm	W1070B	-	-	-	-	-	-	-	-	-	1.926

● **COLONNA 1/2 ANTE TIPO "C"**

Con cinque ripiani interni regolabili

- ◇ La colonna si può ridurre in altezza, senza maggiorazioni di prezzo fino a 149 cm
- ◇ La colonna si può ridurre in profondità, senza maggiorazioni di prezzo fino a 35cm
- ◇ L'apertura dell'anta può essere destra o sinistra

● **TALL UNIT 1/2 DOORS TYPE "C"**

With five internal adjustable shelves

- ◇ The tall unit can be reduced in height, without price surcharge up to 149 cm
- ◇ The tall unit can be reduced in depth, without price surcharge up to 35cm
- ◇ The opening of the door can be right or left

Fusto/Carcase 30 cm	W1030C	-	-	-	-	-	-	-	-	-	1.314
Fusto/Carcase 45 cm	W1045C	-	-	-	-	-	-	-	-	-	1.584
Fusto/Carcase 60 cm	W1060C	-	-	-	-	-	-	-	-	-	1.814
Fusto/Carcase 70 cm	W1070C	-	-	-	-	-	-	-	-	-	1.969

● **COLONNA 1/2 ANTE TIPO "D"**

Con cinque ripiani interni regolabili

- ◇ La colonna si può ridurre in altezza, senza maggiorazioni di prezzo fino a 149 cm
- ◇ La colonna si può ridurre in profondità, senza maggiorazioni di prezzo fino a 35cm
- ◇ L'apertura dell'anta è destra

● **TALL UNIT 1/2 DOORS TYPE "D"**

With five internal adjustable shelves

- ◇ The tall unit can be reduced in height, without price surcharge up to 149 cm
- ◇ The tall unit can be reduced in depth, without price surcharge up to 35cm
- ◇ The opening of the door is right

Fusto/Carcase 30 cm	W1030D	-	-	-	-	-	-	-	-	-	1.271
Fusto/Carcase 45 cm	W1045D	-	-	-	-	-	-	-	-	-	1.541
Fusto/Carcase 60 cm	W1060D	-	-	-	-	-	-	-	-	-	1.771
Fusto/Carcase 70 cm	W1070D	-	-	-	-	-	-	-	-	-	1.926

COLONNE DISPENSA WALL
TALL LARDER UNITS WALL

Prof. Depth **65**

Altezza Height **212**

Elemento Unit	Larghezza Width	Codice Code	1	2	3	4	5	6	7	8	9
---------------	-----------------	-------------	---	---	---	---	---	---	---	---	---

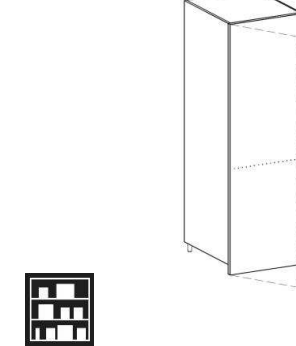

● **COLONNA 1/2 ANTE APERTURA PUSH PULL TIPO "A"**

Con cinque ripiani interni regolabili

- ◇ La colonna si può ridurre in altezza, senza maggiorazioni di prezzo fino a 149 cm
- ◇ La colonna si può ridurre in profondità, senza maggiorazioni di prezzo fino a 45cm
- ◇ L'apertura dell'anta può essere destra o sinistra

● **TALL UNIT 1/2 DOORS WITH OPENING PUSH PULL TYPE "A"**

With five internal adjustable shelves

- ◇ The tall unit can be reduced in height, without price surcharge up to 149 cm
- ◇ The tall unit can be reduced in depth, without price surcharge up to 45cm
- ◇ The opening of the door can be right or left

Fusto/Carcase 30 cm	W1030AP	-	-	-	-	-	-	-	-	-	-	1.366
Fusto/Carcase 45 cm	W1045AP	-	-	-	-	-	-	-	-	-	-	1.666
Fusto/Carcase 60 cm	W1060AP	-	-	-	-	-	-	-	-	-	-	1.933
Fusto/Carcase 70 cm	W1070AP	-	-	-	-	-	-	-	-	-	-	2.107

● **COLONNA 1/2 ANTE TIPO "B"**

Con cinque ripiani interni regolabili

- ◇ La colonna si può ridurre in altezza, senza maggiorazioni di prezzo fino a 149 cm
- ◇ La colonna si può ridurre in profondità, senza maggiorazioni di prezzo fino a 45cm
- ◇ L'apertura dell'anta è sinistra

● **TALL UNIT 1/2 DOORS TYPE "B"**

With five internal adjustable shelves

- ◇ The tall unit can be reduced in height, without price surcharge up to 149 cm
- ◇ The tall unit can be reduced in depth, without price surcharge up to 45cm
- ◇ The opening of the door is left

Fusto/Carcase 30 cm	W1030BP	-	-	-	-	-	-	-	-	-	-	1.452
Fusto/Carcase 45 cm	W1045BP	-	-	-	-	-	-	-	-	-	-	1.755
Fusto/Carcase 60 cm	W1060BP	-	-	-	-	-	-	-	-	-	-	2.018
Fusto/Carcase 70 cm	W1070BP	-	-	-	-	-	-	-	-	-	-	2.193

● **COLONNA 1/2 ANTE TIPO "C"**

Con cinque ripiani interni regolabili

- ◇ La colonna si può ridurre in altezza, senza maggiorazioni di prezzo fino a 149 cm
- ◇ La colonna si può ridurre in profondità, senza maggiorazioni di prezzo fino a 45cm
- ◇ L'apertura dell'anta può essere destra o sinistra

● **TALL UNIT 1/2 DOORS TYPE "C"**

With five internal adjustable shelves

- ◇ The tall unit can be reduced in height, without price surcharge up to 149 cm
- ◇ The tall unit can be reduced in depth, without price surcharge up to 45cm
- ◇ The opening of the door can be right or left

Fusto/Carcase 30 cm	W1030CP	-	-	-	-	-	-	-	-	-	-	1.495
Fusto/Carcase 45 cm	W1045CP	-	-	-	-	-	-	-	-	-	-	1.798
Fusto/Carcase 60 cm	W1060CP	-	-	-	-	-	-	-	-	-	-	2.061
Fusto/Carcase 70 cm	W1070CP	-	-	-	-	-	-	-	-	-	-	2.235

● **COLONNA 1/2 ANTE TIPO "D"**

Con cinque ripiani interni regolabili

- ◇ La colonna si può ridurre in altezza, senza maggiorazioni di prezzo fino a 149 cm
- ◇ La colonna si può ridurre in profondità, senza maggiorazioni di prezzo fino a 45cm
- ◇ L'apertura dell'anta è destra

● **TALL UNIT 1/2 DOORS TYPE "D"**

With five internal adjustable shelves

- ◇ The tall unit can be reduced in height, without price surcharge up to 149 cm
- ◇ The tall unit can be reduced in depth, without price surcharge up to 45cm
- ◇ The opening of the door is right

Fusto/Carcase 30 cm	W1030DP	-	-	-	-	-	-	-	-	-	-	1.452
Fusto/Carcase 45 cm	W1045DP	-	-	-	-	-	-	-	-	-	-	1.755
Fusto/Carcase 60 cm	W1060DP	-	-	-	-	-	-	-	-	-	-	2.018
Fusto/Carcase 70 cm	W1070DP	-	-	-	-	-	-	-	-	-	-	2.193

COLONNE DISPENSA WALL
TALL LARDER UNITS WALL

Prof. Depth **40**

Altezza Height **272**

Elemento Unit	Larghezza Width	Codice Code	1	2	3	4	5	6	7	8	9
---------------	-----------------	-------------	---	---	---	---	---	---	---	---	---

	<ul style="list-style-type: none"> COLONNA 1/2 ANTE APERTURA PUSH PULL TIPO "A" Con sette ripiani interni regolabili ◇ La colonna si può ridurre in altezza, senza maggiorazioni di prezzo fino a 212 cm ◇ La colonna si può ridurre in profondità, senza maggiorazioni di prezzo fino a 35cm ◇ L'apertura dell'anta può essere destra o sinistra 											
	<ul style="list-style-type: none"> TALL UNIT 1/2 DOORS WITH OPENING PUSH PULL TYPE "A" With seven internal adjustable shelves ◇ The tall unit can be reduced in height, without price surcharge up to 212 cm ◇ The tall unit can be reduced in depth, without price surcharge up to 35cm ◇ The opening of the door can be right or left 											
	Fusto/Carcase 30 cm	W2030A	-	-	-	-	-	-	-	-	-	1.488
	Fusto/Carcase 45 cm	W2045A	-	-	-	-	-	-	-	-	-	1.785
	Fusto/Carcase 60 cm	W2060A	-	-	-	-	-	-	-	-	-	2.104
Fusto/Carcase 70 cm	W2070A	-	-	-	-	-	-	-	-	-	2.305	

	<ul style="list-style-type: none"> COLONNA 1/2 ANTE TIPO "B" Con sette ripiani interni regolabili ◇ La colonna si può ridurre in altezza, senza maggiorazioni di prezzo fino a 212 cm ◇ La colonna si può ridurre in profondità, senza maggiorazioni di prezzo fino a 35cm ◇ L'apertura dell'anta è sinistra 											
	<ul style="list-style-type: none"> TALL UNIT 1/2 DOORS TYPE "B" With seven internal adjustable shelves ◇ The tall unit can be reduced in height, without price surcharge up to 212 cm ◇ The tall unit can be reduced in depth, without price surcharge up to 35cm ◇ The opening of the door is left 											
	Fusto/Carcase 30 cm	W2030B	-	-	-	-	-	-	-	-	-	1.597
	Fusto/Carcase 45 cm	W2045B	-	-	-	-	-	-	-	-	-	1.916
	Fusto/Carcase 60 cm	W2060B	-	-	-	-	-	-	-	-	-	2.216
Fusto/Carcase 70 cm	W2070B	-	-	-	-	-	-	-	-	-	2.413	

	<ul style="list-style-type: none"> COLONNA 1/2 ANTE TIPO "C" Con sette ripiani interni regolabili ◇ La colonna si può ridurre in altezza, senza maggiorazioni di prezzo fino a 212 cm ◇ La colonna si può ridurre in profondità, senza maggiorazioni di prezzo fino a 35cm ◇ L'apertura dell'anta può essere destra o sinistra 											
	<ul style="list-style-type: none"> TALL UNIT 1/2 DOORS TYPE "C" With seven internal adjustable shelves ◇ The tall unit can be reduced in height, without price surcharge up to 212 cm ◇ The tall unit can be reduced in depth, without price surcharge up to 35cm ◇ The opening of the door can be right or left 											
	Fusto/Carcase 30 cm	W2030C	-	-	-	-	-	-	-	-	-	1.653
	Fusto/Carcase 45 cm	W2045C	-	-	-	-	-	-	-	-	-	1.969
	Fusto/Carcase 60 cm	W2060C	-	-	-	-	-	-	-	-	-	2.268
Fusto/Carcase 70 cm	W2070C	-	-	-	-	-	-	-	-	-	2.469	

	<ul style="list-style-type: none"> COLONNA 1/2 ANTE TIPO "D" Con sette ripiani interni regolabili ◇ La colonna si può ridurre in altezza, senza maggiorazioni di prezzo fino a 212 cm ◇ La colonna si può ridurre in profondità, senza maggiorazioni di prezzo fino a 35cm ◇ L'apertura dell'anta è destra 											
	<ul style="list-style-type: none"> TALL UNIT 1/2 DOORS TYPE "D" With seven internal adjustable shelves ◇ The tall unit can be reduced in height, without price surcharge up to 212 cm ◇ The tall unit can be reduced in depth, without price surcharge up to 35cm ◇ The opening of the door is right 											
	Fusto/Carcase 30 cm	W2030D	-	-	-	-	-	-	-	-	-	1.597
	Fusto/Carcase 45 cm	W2045D	-	-	-	-	-	-	-	-	-	1.916
	Fusto/Carcase 60 cm	W2060D	-	-	-	-	-	-	-	-	-	2.216
Fusto/Carcase 70 cm	W2070D	-	-	-	-	-	-	-	-	-	2.413	

COLONNE DISPENSA WALL
TALL LARDER UNITS WALL

Prof. Depth **65**

Altezza Height **272**

Elemento Unit	Larghezza Width	Codice Code	1	2	3	4	5	6	7	8	9
---------------	-----------------	-------------	---	---	---	---	---	---	---	---	---

	<ul style="list-style-type: none"> COLONNA 1/2 ANTE APERTURA PUSH PULL TIPO "A" Con sette ripiani interni regolabili ◇ La colonna si può ridurre in altezza, senza maggiorazioni di prezzo fino a 212 cm ◇ La colonna si può ridurre in profondità, senza maggiorazioni di prezzo fino a 45cm ◇ L'apertura dell'anta può essere destra o sinistra 											
	<ul style="list-style-type: none"> TALL UNIT 1/2 DOORS WITH OPENING PUSH PULL TYPE "A" With seven internal adjustable shelves ◇ The tall unit can be reduced in height, without price surcharge up to 212 cm ◇ The tall unit can be reduced in depth, without price surcharge up to 45cm ◇ The opening of the door can be right or left 											
	Fusto/Carcase 30 cm	W2030AP	-	-	-	-	-	-	-	-	-	1.719
	Fusto/Carcase 45 cm	W2045AP	-	-	-	-	-	-	-	-	-	2.081
	Fusto/Carcase 60 cm	W2060AP	-	-	-	-	-	-	-	-	-	2.423
Fusto/Carcase 70 cm	W2070AP	-	-	-	-	-	-	-	-	-	2.650	

	<ul style="list-style-type: none"> COLONNA 1/2 ANTE TIPO "B" Con sette ripiani interni regolabili ◇ La colonna si può ridurre in altezza, senza maggiorazioni di prezzo fino a 212 cm ◇ La colonna si può ridurre in profondità, senza maggiorazioni di prezzo fino a 45cm ◇ L'apertura dell'anta è sinistra 											
	<ul style="list-style-type: none"> TALL UNIT 1/2 DOORS TYPE "B" With seven internal adjustable shelves ◇ The tall unit can be reduced in height, without price surcharge up to 212 cm ◇ The tall unit can be reduced in depth, without price surcharge up to 45cm ◇ The opening of the door is left 											
	Fusto/Carcase 30 cm	W2030BP	-	-	-	-	-	-	-	-	-	1.831
	Fusto/Carcase 45 cm	W2045BP	-	-	-	-	-	-	-	-	-	2.189
	Fusto/Carcase 60 cm	W2060BP	-	-	-	-	-	-	-	-	-	2.532
Fusto/Carcase 70 cm	W2070BP	-	-	-	-	-	-	-	-	-	2.759	



	<ul style="list-style-type: none"> COLONNA 1/2 ANTE TIPO "C" Con sette ripiani interni regolabili ◇ La colonna si può ridurre in altezza, senza maggiorazioni di prezzo fino a 212 cm ◇ La colonna si può ridurre in profondità, senza maggiorazioni di prezzo fino a 45cm ◇ L'apertura dell'anta può essere destra o sinistra 											
	<ul style="list-style-type: none"> TALL UNIT 1/2 DOORS TYPE "C" With seven internal adjustable shelves ◇ The tall unit can be reduced in height, without price surcharge up to 210 cm ◇ The tall unit can be reduced in depth, without price surcharge up to 45cm ◇ The opening of the door can be right or left 											
	Fusto/Carcase 30 cm	W2030CP	-	-	-	-	-	-	-	-	-	1.887
	Fusto/Carcase 45 cm	W2045CP	-	-	-	-	-	-	-	-	-	2.245
	Fusto/Carcase 60 cm	W2060CP	-	-	-	-	-	-	-	-	-	2.588
Fusto/Carcase 70 cm	W2070CP	-	-	-	-	-	-	-	-	-	2.815	

	<ul style="list-style-type: none"> COLONNA 1/2 ANTE TIPO "D" Con sette ripiani interni regolabili ◇ La colonna si può ridurre in altezza, senza maggiorazioni di prezzo fino a 212 cm ◇ La colonna si può ridurre in profondità, senza maggiorazioni di prezzo fino a 45cm ◇ L'apertura dell'anta è destra 											
	<ul style="list-style-type: none"> TALL UNIT 1/2 DOORS TYPE "D" With seven internal adjustable shelves ◇ The tall unit can be reduced in height, without price surcharge up to 212 cm ◇ The tall unit can be reduced in depth, without price surcharge up to 45cm ◇ The opening of the door is right 											
	Fusto/Carcase 30 cm	W2030DP	-	-	-	-	-	-	-	-	-	1.831
	Fusto/Carcase 45 cm	W2045DP	-	-	-	-	-	-	-	-	-	2.173
	Fusto/Carcase 60 cm	W2060DP	-	-	-	-	-	-	-	-	-	2.532
Fusto/Carcase 70 cm	W2070DP	-	-	-	-	-	-	-	-	-	2.759	

COLONNE DISPENSA WALL
TALL LARDER UNITS WALL

Prof. Depth **40**

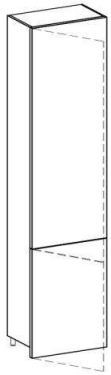
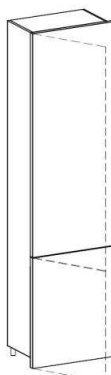
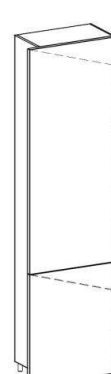
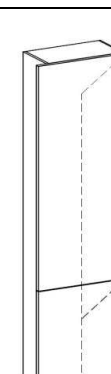

Altezza Height **332**

Elemento Unit	Larghezza Width	Codice Code	1	2	3	4	5	6	7	8	9	
 <ul style="list-style-type: none"> COLONNA 1/2 ANTE APERTURA PUSH PULL TIPO "A" Con nove ripiani interni regolabili ◇ La colonna si può ridurre in altezza, senza maggiorazioni di prezzo fino a 272 cm ◇ La colonna si può ridurre in profondità, senza maggiorazioni di prezzo fino a 35cm ◇ L'apertura dell'anta può essere destra o sinistra 												
 <ul style="list-style-type: none"> TALL UNIT 1/2 DOORS WITH OPENING PUSH PULL TYPE "A" With nine internal adjustable shelves ◇ The tall unit can be reduced in height, without price surcharge up to 272 cm ◇ The tall unit can be reduced in depth, without price surcharge up to 35cm ◇ The opening of the door can be right or left 	Fusto/Carcase 30 cm	W3030A	-	-	-	-	-	-	-	-	1.732	
	Fusto/Carcase 45 cm	W3045A	-	-	-	-	-	-	-	-	2.087	
	Fusto/Carcase 60 cm	W3060A	-	-	-	-	-	-	-	-	2.463	
	Fusto/Carcase 70 cm	W3070A	-	-	-	-	-	-	-	-	2.700	
 <ul style="list-style-type: none"> COLONNA 1/2 ANTE TIPO "B" Con nove ripiani interni regolabili ◇ La colonna si può ridurre in altezza, senza maggiorazioni di prezzo fino a 272 cm ◇ La colonna si può ridurre in profondità, senza maggiorazioni di prezzo fino a 35cm ◇ L'apertura dell'anta è sinistra 												
 <ul style="list-style-type: none"> TALL UNIT 1/2 DOORS TYPE "B" With nine internal adjustable shelves ◇ The tall unit can be reduced in height, without price surcharge up to 272 cm ◇ The tall unit can be reduced in depth, without price surcharge up to 35cm ◇ The opening of the door is left 	Fusto/Carcase 30 cm	W3030B	-	-	-	-	-	-	-	-	1.857	
	Fusto/Carcase 45 cm	W3045B	-	-	-	-	-	-	-	-	2.232	
	Fusto/Carcase 60 cm	W3060B	-	-	-	-	-	-	-	-	2.588	
	Fusto/Carcase 70 cm	W3070B	-	-	-	-	-	-	-	-	2.825	
 <ul style="list-style-type: none"> COLONNA 1/2 ANTE TIPO "C" Con nove ripiani interni regolabili ◇ La colonna si può ridurre in altezza, senza maggiorazioni di prezzo fino a 272 cm ◇ La colonna si può ridurre in profondità, senza maggiorazioni di prezzo fino a 35cm ◇ L'apertura dell'anta può essere destra o sinistra 												
<ul style="list-style-type: none"> TALL UNIT 1/2 DOORS TYPE "C" With nine internal adjustable shelves ◇ The tall unit can be reduced in height, without price surcharge up to 272 cm ◇ The tall unit can be reduced in depth, without price surcharge up to 35cm ◇ The opening of the door can be right or left 	Fusto/Carcase 30 cm	W3030C	-	-	-	-	-	-	-	-	1.923	
	Fusto/Carcase 45 cm	W3045C	-	-	-	-	-	-	-	-	2.295	
	Fusto/Carcase 60 cm	W3060C	-	-	-	-	-	-	-	-	2.650	
	Fusto/Carcase 70 cm	W3070C	-	-	-	-	-	-	-	-	2.887	
<ul style="list-style-type: none"> COLONNA 1/2 ANTE TIPO "D" Con nove ripiani interni regolabili ◇ La colonna si può ridurre in altezza, senza maggiorazioni di prezzo fino a 272 cm ◇ La colonna si può ridurre in profondità, senza maggiorazioni di prezzo fino a 35cm ◇ L'apertura dell'anta è destra 												
<ul style="list-style-type: none"> TALL UNIT 1/2 DOORS TYPE "D" With nine internal adjustable shelves ◇ The tall unit can be reduced in height, without price surcharge up to 272 cm ◇ The tall unit can be reduced in depth, without price surcharge up to 35cm ◇ The opening of the door is right 	Fusto/Carcase 30 cm	W3030D	-	-	-	-	-	-	-	-	1.857	
	Fusto/Carcase 45 cm	W3045D	-	-	-	-	-	-	-	-	2.232	
	Fusto/Carcase 60 cm	W3060D	-	-	-	-	-	-	-	-	2.588	
	Fusto/Carcase 70 cm	W3070D	-	-	-	-	-	-	-	-	2.825	

COLONNE DISPENSA WALL
TALL LARDER UNITS WALL

Prof. Depth **65**

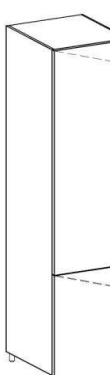
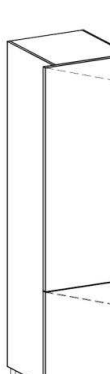
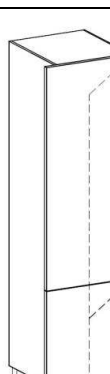
Altezza Height **332**

Elemento Unit	Larghezza Width	Codice Code	1	2	3	4	5	6	7	8	9	
 <ul style="list-style-type: none"> COLONNA 1/2 ANTE APERTURA PUSH PULL TIPO "A" Con nove ripiani interni regolabili ◇ La colonna si può ridurre in altezza, senza maggiorazioni di prezzo fino a 272 cm ◇ La colonna si può ridurre in profondità, senza maggiorazioni di prezzo fino a 45cm ◇ L'apertura dell'anta può essere destra o sinistra 												
 <ul style="list-style-type: none"> TALL UNIT 1/2 DOORS WITH OPENING PUSH PULL TYPE "A" With nine internal adjustable shelves ◇ The tall unit can be reduced in height, without price surcharge up to 272 cm ◇ The tall unit can be reduced in depth, without price surcharge up to 45cm ◇ The opening of the door can be right or left 	Fusto/Carcase 30 cm	W3030AP	-	-	-	-	-	-	-	-	2.018	
	Fusto/Carcase 45 cm	W3045AP	-	-	-	-	-	-	-	-	2.426	
	Fusto/Carcase 60 cm	W3060AP	-	-	-	-	-	-	-	-	2.854	
	Fusto/Carcase 70 cm	W3070AP	-	-	-	-	-	-	-	-	3.124	
 <ul style="list-style-type: none"> COLONNA 1/2 ANTE TIPO "B" Con nove ripiani interni regolabili ◇ La colonna si può ridurre in altezza, senza maggiorazioni di prezzo fino a 272 cm ◇ La colonna si può ridurre in profondità, senza maggiorazioni di prezzo fino a 45cm ◇ L'apertura dell'anta è sinistra 												
 <ul style="list-style-type: none"> TALL UNIT 1/2 DOORS TYPE "B" With nine internal adjustable shelves ◇ The tall unit can be reduced in height, without price surcharge up to 272 cm ◇ The tall unit can be reduced in depth, without price surcharge up to 45cm ◇ The opening of the door is left 	Fusto/Carcase 30 cm	W3030BP	-	-	-	-	-	-	-	-	2.143	
	Fusto/Carcase 45 cm	W3045BP	-	-	-	-	-	-	-	-	2.571	
	Fusto/Carcase 60 cm	W3060BP	-	-	-	-	-	-	-	-	2.979	
	Fusto/Carcase 70 cm	W3070BP	-	-	-	-	-	-	-	-	3.249	
 <ul style="list-style-type: none"> COLONNA 1/2 ANTE TIPO "C" Con nove ripiani interni regolabili ◇ La colonna si può ridurre in altezza, senza maggiorazioni di prezzo fino a 272 cm ◇ La colonna si può ridurre in profondità, senza maggiorazioni di prezzo fino a 45cm ◇ L'apertura dell'anta può essere destra o sinistra 												
<ul style="list-style-type: none"> TALL UNIT 1/2 DOORS TYPE "C" With nine internal adjustable shelves ◇ The tall unit can be reduced in height, without price surcharge up to 272 cm ◇ The tall unit can be reduced in depth, without price surcharge up to 45cm ◇ The opening of the door can be right or left 	Fusto/Carcase 30 cm	W3030CP	-	-	-	-	-	-	-	-	2.209	
	Fusto/Carcase 45 cm	W3045CP	-	-	-	-	-	-	-	-	2.634	
	Fusto/Carcase 60 cm	W3060CP	-	-	-	-	-	-	-	-	3.042	
	Fusto/Carcase 70 cm	W3070CP	-	-	-	-	-	-	-	-	3.312	
<ul style="list-style-type: none"> COLONNA 1/2 ANTE TIPO "D" Con nove ripiani interni regolabili ◇ La colonna si può ridurre in altezza, senza maggiorazioni di prezzo fino a 272 cm ◇ La colonna si può ridurre in profondità, senza maggiorazioni di prezzo fino a 45cm ◇ L'apertura dell'anta è destra 												
<ul style="list-style-type: none"> TALL UNIT 1/2 DOORS TYPE "D" With nine internal adjustable shelves ◇ The tall unit can be reduced in height, without price surcharge up to 272 cm ◇ The tall unit can be reduced in depth, without price surcharge up to 45cm ◇ The opening of the door is right 	Fusto/Carcase 30 cm	W3030DP	-	-	-	-	-	-	-	-	2.143	
	Fusto/Carcase 45 cm	W3045DP	-	-	-	-	-	-	-	-	2.571	
	Fusto/Carcase 60 cm	W3060DP	-	-	-	-	-	-	-	-	2.979	
	Fusto/Carcase 70 cm	W3070DP	-	-	-	-	-	-	-	-	3.249	

Elemento Unit	Larghezza Width	Codice Code	1	2	3	4	5	6	7	8	9
------------------	--------------------	----------------	---	---	---	---	---	---	---	---	---

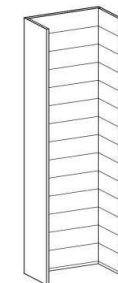

• **MODULO EFFETTO DOGHE H.212**

Predisposto per l'inserimento di mensole in metallo

◊ Il vano si può ridurre in altezza, senza maggiorazioni di prezzo fino a 149 cm

• **MODUL WITH BEADS H212**

Prepared for the insertion of metal shelves

◊ The tall unit can be reduced in height, without price surcharge up to 149 cm

Larghezza/Width 30 cm	W1030G	-	619	-	-	991	-	-	-	-	-
Larghezza/Width 45 cm	W1045G	-	682	-	-	1.116	-	-	-	-	-
Larghezza/Width 60 cm	W1060G	-	744	-	-	1.241	-	-	-	-	-
Larghezza/Width 70 cm	W1070G	-	787	-	-	1.327	-	-	-	-	-

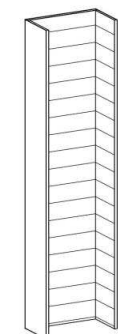

• **MODULO EFFETTO DOGHE H.272**

Predisposto per l'inserimento di mensole in metallo

◊ Il vano si può ridurre in altezza, senza maggiorazioni di prezzo fino a 212 cm

• **MODUL WITH BEADS H272**

Prepared for the insertion of metal shelves

◊ The tall unit can be reduced in height, without price surcharge up to 212 cm

Larghezza/Width 30 cm	W2030G	-	728	-	-	1.215	-	-	-	-	-
Larghezza/Width 45 cm	W2045G	-	807	-	-	1.376	-	-	-	-	-
Larghezza/Width 60 cm	W2060G	-	883	-	-	1.538	-	-	-	-	-
Larghezza/Width 70 cm	W2070G	-	935	-	-	1.646	-	-	-	-	-

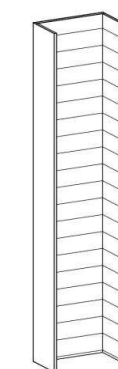

• **MODULO EFFETTO DOGHE H.332**

Predisposto per l'inserimento di mensole in metallo

◊ Il vano si può ridurre in altezza, senza maggiorazioni di prezzo fino a 272 cm

• **MODUL WITH BEADS H332**

Prepared for the insertion of metal shelves

◊ The tall unit can be reduced in height, without price surcharge up to 272 cm

Larghezza/Width 30 cm	W3045G	-	932	-	-	1.640	-	-	-	-	-
Larghezza/Width 45 cm	W3045G	-	932	-	-	1.640	-	-	-	-	-
Larghezza/Width 60 cm	W3060G	-	1.024	-	-	1.834	-	-	-	-	-
Larghezza/Width 70 cm	W3070G	-	1.087	-	-	1.966	-	-	-	-	-

• **MENSOLA IN METALLO
PER MODULI A GIORNO**



• **METAL SHELF
FOR MODUL WITH BEADS**

Larghezza / Width 20 cm	WLA020	89
Larghezza / Width 35 cm	WLA035	103
Larghezza / Width 50 cm	WLA050	116
Larghezza / Width 60 cm	WLA060	129

Elemento Unit	Larghezza Width	Codice Code	1	2	3	4	5	6	7	8	9
------------------	--------------------	----------------	---	---	---	---	---	---	---	---	---

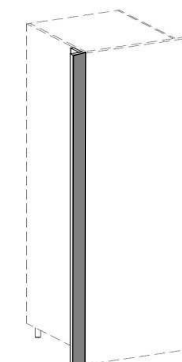

• **FASCIA DI TAMPONAMENTO LATERALE
PER COLONNA WALL**

Larghezza 2±22 cm

• **A REAR SIDE BAND FOR WALL UNIT**

Width 2±22 cm

Altezza/Height 210	TW210	-	-	-	-	-	-	-	-	-	237
Altezza/Height 270	TW270	-	-	-	-	-	-	-	-	-	297
Altezza/Height 330	TW330	-	-	-	-	-	-	-	-	-	356

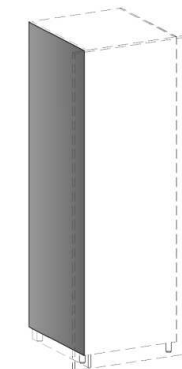

• **SUPPLEMENTO PER FIANCO COLONNA
RESINATO**

• **SUPPLEMENT TO THE SIDE WALL UNIT
RESINED**

Alt/Height 212 Prof/Depth 40	FWW212A	-	-	-	-	-	-	-	-	-	175
Alt/Height 272 Prof/Depth 40	FWW272A	-	-	-	-	-	-	-	-	-	218
Alt/Height 332 Prof/Depth 40	FWW332A	-	-	-	-	-	-	-	-	-	257

Alt/Height 212 Prof/Depth 65	FWW212B	-	-	-	-	-	-	-	-	-	237
Alt/Height 272 Prof/Depth 65	FWW272B	-	-	-	-	-	-	-	-	-	297
Alt/Height 332 Prof/Depth 65	FWW332B	-	-	-	-	-	-	-	-	-	353

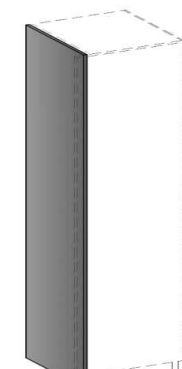

• **FIANCO DI FINITURA RESINATO A
RIPORTO**

• **SIDE FINISHING RESIN A CARRY**

Alt/Height 212 Prof/Depth 40	FRW212A	-	-	-	-	-	-	-	-	-	359
Alt/Height 272 Prof/Depth 40	FRW272A	-	-	-	-	-	-	-	-	-	448
Alt/Height 332 Prof/Depth 40	FRW332A	-	-	-	-	-	-	-	-	-	537

Alt/Height 212 Prof/Depth 65	FRW212B	-	-	-	-	-	-	-	-	-	498
Alt/Height 272 Prof/Depth 65	FRW272B	-	-	-	-	-	-	-	-	-	623
Alt/Height 332 Prof/Depth 65	FRW332B	-	-	-	-	-	-	-	-	-	748

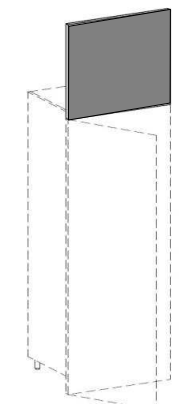

• **PANNELLO FISSO RESINATO**



Con struttura grezza per posa

• **PANEL FIXED RESINED**

With coarse structure for laying

Prezzo al mq Price for square metre	PW000	-	-	-	-	-	-	-	-	-	376
--	--------------	---	---	---	---	---	---	---	---	---	-----

OPZIONI PER COLONNE WALL OPTIONS FOR TALL UNITS WALL

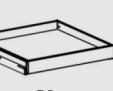
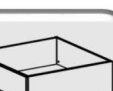
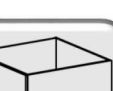
	<ul style="list-style-type: none"> ● SUPPLEMENTO PER INSERIMENTO FORNO ● SUPPLEMENT FOR ENTERING THE OVEN 	Per ogni colonna/For each tall unit	OPZFOR	132
	<ul style="list-style-type: none"> ● SUPPLEMENTO PER INSERIMENTO FRIGO ● SUPPLEMENT FOR ENTERING THE FRIDGE 	Per ogni colonna/For each tall unit	OPZFRI	66
 N H. 6,9	<ul style="list-style-type: none"> ● CASSETTO INTERNO LEGRABOX-N O LEGNO (INGOMBRO MINIMO H.8) Profondità e portata in base alle misure del vano o su specifica richiesta ● DRAWER INTERNAL LEGRABOX-N (MINIMUM ENCUMBRANCE H.8) The depth depends on the measures of the compartment or on special request 	CASSETTO LEGRABOX Largh. da/Width from 20 a/to 95 CASSETTO IN LEGNO Largh. da/Width from 20 a/to 95	OPZLGR_N	198
 M	<ul style="list-style-type: none"> ● CASSETTO INTERNO LEGRABOX-M O LEGNO (INGOMBRO MINIMO H.10,4) Profondità e portata in base alle misure del vano o su specifica richiesta ● DRAWER INTERNAL LEGRABOX-M (MINIMUM ENCUMBRANCE H.10,4) The depth depends on the measures of the compartment or on special request 	CASSETTO LEGRABOX Largh. da/Width from 20 a/to 95 CASSETTO IN LEGNO Largh. da/Width from 20 a/to 95	OPZLGR_M	195
 K H. 13	<ul style="list-style-type: none"> ● CASSETTO INTERNO LEGRABOX-K O LEGNO (INGOMBRO MINIMO H.14,4) Profondità e portata in base alle misure del vano o su specifica richiesta ● DRAWER INTERNAL LEGRABOX-K (MINIMUM ENCUMBRANCE H.14,4) The depth depends on the measures of the compartment or on special request 	CASSETTO LEGRABOX Largh. da/Width from 20 a/to 95 CASSETTO IN LEGNO Largh. da/Width from 20 a/to 95	OPZLGR_K	218
 C H. 17,8	<ul style="list-style-type: none"> ● CASSETTO INTERNO LEGRABOX-C O LEGNO (INGOMBRO MINIMO H.19,3) Profondità e portata in base alle misure del vano o su specifica richiesta ● DRAWER INTERNAL LEGRABOX-C (MINIMUM ENCUMBRANCE H.19,3) The depth depends on the measures of the compartment or on special request 	CASSETTO LEGRABOX Largh. da/Width from 20 a/to 95 CASSETTO IN LEGNO Largh. da/Width from 20 a/to 95	OPZLGR_C	231
 F H. 24,2	<ul style="list-style-type: none"> ● CASSETTO INTERNO LEGRABOX-F O LEGNO (INGOMBRO MINIMO H.19,3) Profondità e portata in base alle misure del vano o su specifica richiesta ● DRAWER INTERNAL LEGRABOX-F (MINIMUM ENCUMBRANCE H.19,3) The depth depends on the measures of the compartment or on special request 	CASSETTO LEGRABOX Largh. da/Width from 20 a/to 95 CASSETTO IN LEGNO Largh. da/Width from 20 a/to 95	OPZLGR_F	284
			OPZLGN_N	214
			OPZLGN_M	224
			OPZLGN_K	237
			OPZLGN_C	257
			OPZLGN_F	284

WWW.TABULACUCINE.IT